

PFR5151J63J11L4BULK

aka F411JH151J063C

Capacitor, film, 150 pF, +/-5% Tol, -55/+100C, Pulse, 63V@100C, Lead Spacing=5 mm

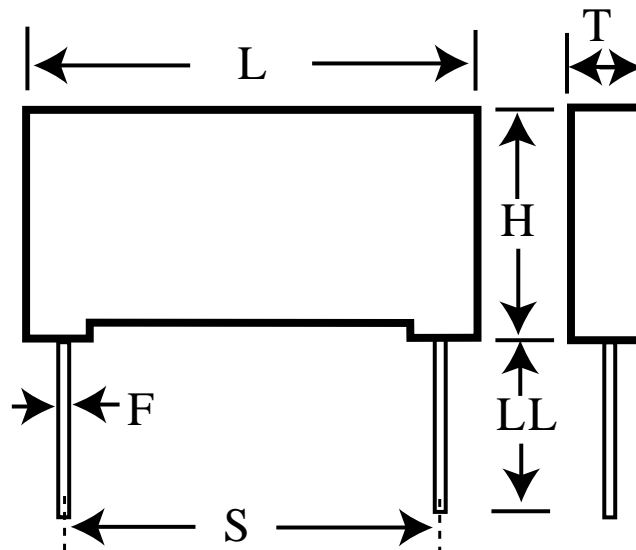

Dimensions (mm)

ID	Dimension	Tolerance
L	7.2	max
H	6	max
T	4.5	max
S	5	+/-0.4
LL	5	nom
F	0.5	nom

Specifications

Manufacturer:	KEMET
Brand:	Evox
Capacitance:	150 pF
Temperature Range:	-55/+100C
Rated Temperature:	100C
Voltage @ rated temp:	63V
Voltage AC:	40VAC
Tolerance:	+/-5%
Body Type:	Radial Box
Construction:	Non-inductive
Application:	Pulse
Dielectric:	Film-Foil Polyester
Dissipation Factor @ 1 kHz:	0.04%
Insulation Resistance:	500 GOhm
Inductance:	6 nH
Maximum dVdT:	1000v/us
Miscellaneous Electrical:	PFR
Package Kind:	Bulk
Package Quantity:	1000