

DC Film Capacitor MKT Radial Potted Type

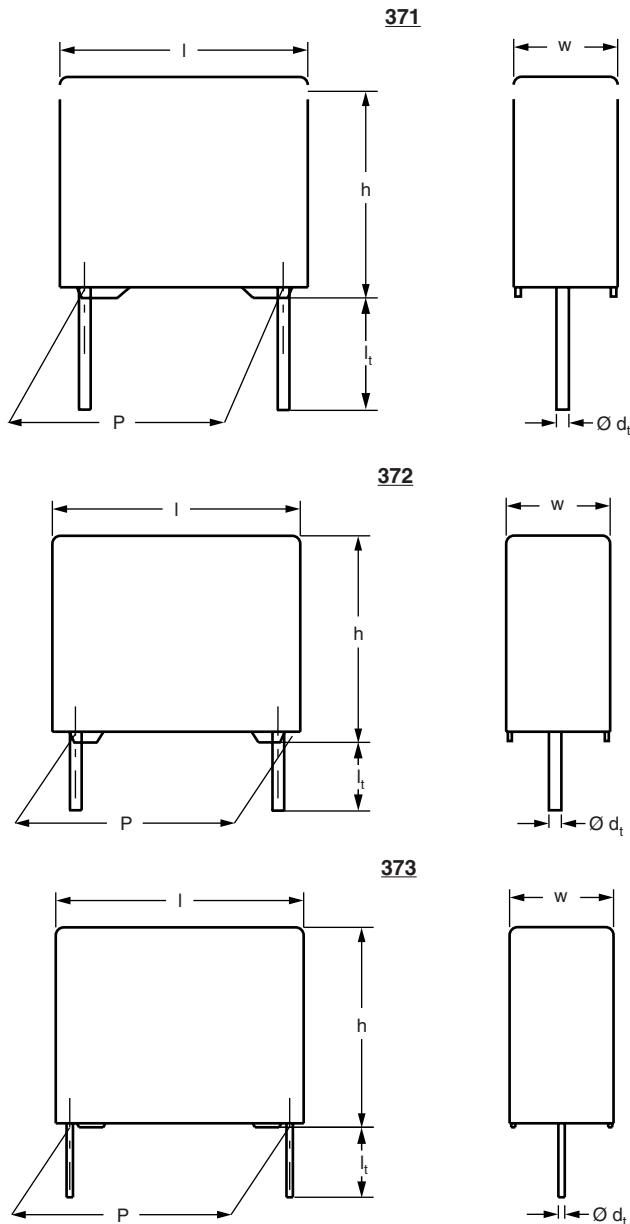

FEATURES

371: 7.62 mm lead pitch. Supplied loose in box and taped on reel or ammpack
372: 10 mm lead pitch. Supplied loose in box and taped on reel or ammpack
373: 15 mm to 27.5 mm lead pitch. Supplied loose in box and taped on reel.
 RoHS compliant



RoHS
COMPLIANT

DIELECTRIC

Polyester film

ELECTRODES

Metallized

CONSTRUCTION

Mono construction

RATED (DC) VOLTAGE

371: 63 V, 100 V, 250 V, 400 V
372, 373: 100 V, 250 V, 400 V, 630 V

RATED (AC) VOLTAGE

371: 40 V, 63 V, 160 V, 220 V
372, 373: 63 V, 160 V, 220 V, 250 V

ENCAPSULATION

Flame retardant plastic case and epoxy resin
 (UL-class 94 V-0)

CLIMATIC TESTING CLASS ACC. TO IEC 60068-1

55/105/56

CAPACITANCE RANGE (E12 SERIES)

371: 0.0039 μ F to 1.5 μ F
372: 0.0047 μ F to 0.68 μ F
373: 0.047 μ F to 15 μ F

CAPACITANCE TOLERANCE

$\pm 10 \%$, $\pm 5 \%$

LEADS

Tinned wire

RATED TEMPERATURE

85 °C

MAXIMUM APPLICATION TEMPERATURE

105 °C

PERFORMANCE GRADE

Grade 1 (long life)

DETAIL SPECIFICATION

For more detailed data and test requirements contact:
dc-film@vishay.com

APPLICATIONS

Blocking and coupling, bypass and energy reservoir.

REFERENCE STANDARDS

IEC 60384-2

MARKING

C-value; tolerance; rated voltage; manufacturer's symbol;
 year and week of manufacturer; manufacturer's type



COMPOSITION OF CATALOG NUMBER: 371

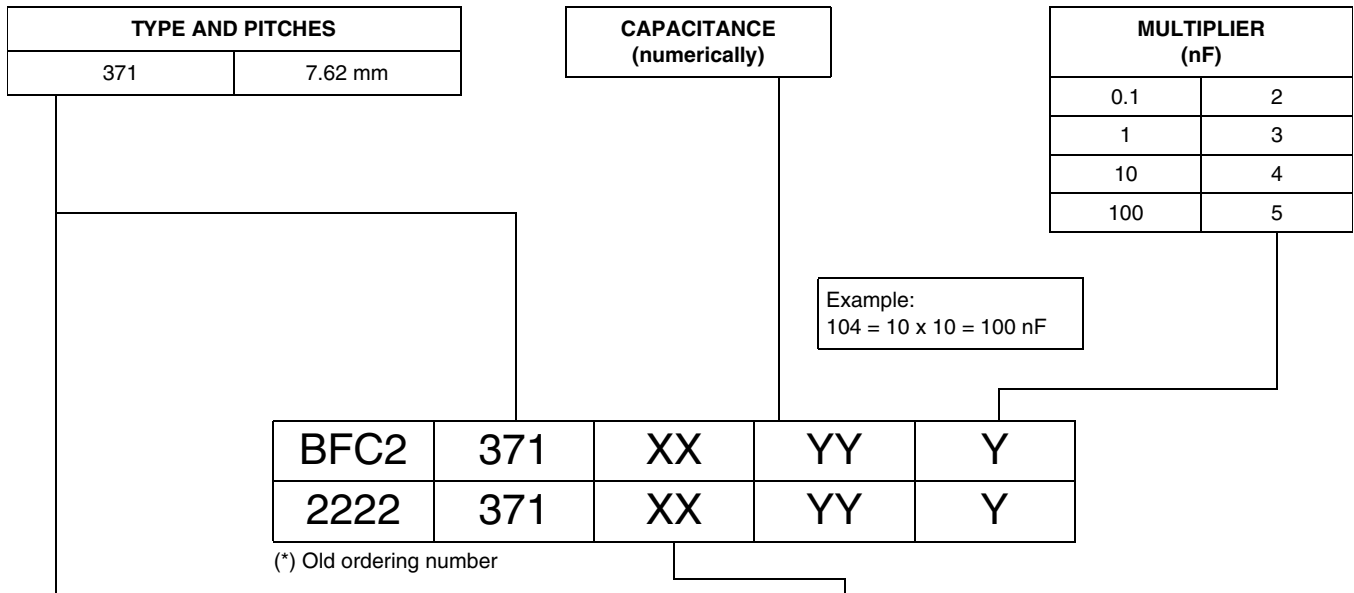

TYPE	PACKAGING	LEAD CONFIGURATION	PREFERRED TYPES				
			C-TOL.	63 V	100 V	250 V	400 V
371	Loose in box	Lead length 4.0 + 1.0/- 0.5 mm	± 10 %	11	21	41	51
			± 5 %	12	22	42	52
		Lead length 26.0 ± 2.0 mm	± 10 %	15	25	45	55
			± 5 %	16	26	46	56
	Taped on reel (1)	H (1) = 18.5 mm P ₀ = 12.7 mm	± 10 %	35	65	75	85
			± 5 %	36	66	76	86
	Ammopack (1)	H (1) = 18.5 mm P ₀ = 12.7 mm	± 10 %	38	68	78	88
			± 5 %	39	69	79	89

Notes

- (1) For detailed tape specifications refer to packaging information: www.vishay.com/doc?28139 or end of catalog
- (2) SPQ = Standard Packing Quantity

SPECIFIC REFERENCE DATA

DESCRIPTION	VALUE			
	at 1 kHz	at 10 kHz	at 100 kHz	
Tangent of loss angle: C ≤ 0.1 μF	≤ 75 x 10 ⁻⁴	≤ 130 x 10 ⁻⁴	≤ 250 x 10 ⁻⁴	
0.1 μF < C ≤ 0.47 μF	≤ 75 x 10 ⁻⁴	≤ 130 x 10 ⁻⁴	≤ 250 x 10 ⁻⁴	
0.47 μF < C ≤ 1.5 μF	≤ 75 x 10 ⁻⁴	≤ 130 x 10 ⁻⁴	-	
Rated voltage pulse slope (dU/dt) _R at	63 Vdc	100 Vdc	250 Vdc	400 Vdc
	18 V/μs	36 V/μs	70 V/μs	190 V/μs
R between leads, for C ≤ 0.33 μF at 10 V; 1 min at 100 V; 1 min	> 15 000 MΩ	> 15 000 MΩ	> 30 000 MΩ	> 30 000 MΩ
RC between leads, for C > 0.33 μF at 10 V; 1 min at 100 V; 1 min	> 5000 s	> 5000 s	-	-
R between interconnecting leads and case (foil method)	> 30 000 MΩ			
Withstanding (DC) voltage (cut off current 10 mA); rise time 100 V/s	100 V; 1 min	160 V; 1 min	400 V; 1 min	640 V; 1 min
Withstanding (DC) voltage between leads and case	200 V; 1 min	20 V; 1 min	500 V; 1 min	800 V; 1 min
Maximum application temperature	105 °C			

MKT 371, MKT 372, MKT 373



Vishay BCcomponents

DC Film Capacitor
MKT Radial Potted Type

$U_{Rdc} = 63 \text{ V}$; $U_{Rac} = 40 \text{ V}$

C (μF)	DIMENSIONS w x h x l (mm)	MASS (g) ⁽¹⁾	CATALOG NUMBER BFC2 371 XXYYY AND PACKAGING									
			LOOSE IN BOX				AMMOPACK		REEL		C-VALUE	
			$l_t = 4.0 + 1.0/- 0.5 \text{ mm}$		$l_t = 26.0 \pm 2.0 \text{ mm}$		H = 18.5 mm; P ₀ = 12.7 mm		H = 18.5 mm; P ₀ = 12.7 mm			
			C-tol. = $\pm 10 \%$	C-tol. = $\pm 5 \%$	C-tol. = $\pm 10 \%$	C-tol. = $\pm 5 \%$	C-tol. = $\pm 10 \%$	C-tol. = $\pm 5 \%$	C-tol. = $\pm 10 \%$	C-tol. = $\pm 5 \%$		
XX (SPQ)	XX (SPQ)	XX (SPQ)	XX (SPQ)	XX (SPQ)	XX (SPQ)	XX (SPQ)	XX (SPQ)	XX (SPQ)	XX (SPQ)	..YYY		
Pitch = 7.62 + 0.30/- 0.40 mm; $d_t = 0.50 \pm 0.05 \text{ mm}$												
0.056 0.068 0.082 0.1	2.5 x 6.5 x 10.0	0.24	11... (1000)	12... (1000)	15... (1000)	16... (1000)	38... (2000)	39... (2000)	35... (2000)	36... (2000)	563 683 823 104	
0.12 0.15 0.18 0.22	3.0 x 8.0 x 10.0	0.34	11... (1000)	12... (1000)	15... (1000)	16... (1000)	38... (1500)	39... (1500)	35... (1500)	36... (1500)	124 154 184 224	
0.27 0.33 0.39 0.47 0.56 0.68	4.0 x 9.0 x 10.0	0.51	11... (1000)	12... (1000)	15... (1000)	16... (1000)	38... (1000)	39... (1000)	35... (1500)	36... (1500)	274 334 394 474 564 684	
0.82 1.0	5.0 x 10.5 x 10.0	0.73	11... (1000)	12... (1000)	15... (1000)	16... (1000)	38... (1000)	39... (1000)	35... (1000)	36... (1000)	824 105	
1.2 1.5	6.0 x 11.5 x 10.0	1.0	11... (750)	12... (750)	15... (1000)	16... (1000)	38... (500)	39... (500)	35... (500)	36... (500)	125 155	

Note

⁽¹⁾ Weight for short lead products only

$U_{Rdc} = 100 \text{ V}$; $U_{Rac} = 63 \text{ V}$

C (μF)	DIMENSIONS w x h x l (mm)	MASS (g) ⁽¹⁾	CATALOG NUMBER BFC2 371 XXYYY AND PACKAGING									
			LOOSE IN BOX				AMMOPACK		REEL		C-VALUE	
			$l_t = 4.0 + 1.0/- 0.5 \text{ mm}$		$l_t = 26.0 \pm 2.0 \text{ mm}$		H = 18.5 mm; P ₀ = 12.7 mm		H = 18.5 mm; P ₀ = 12.7 mm			
			C-tol. = $\pm 10 \%$	C-tol. = $\pm 5 \%$	C-tol. = $\pm 10 \%$	C-tol. = $\pm 5 \%$	C-tol. = $\pm 10 \%$	C-tol. = $\pm 5 \%$	C-tol. = $\pm 10 \%$	C-tol. = $\pm 5 \%$		
XX (SPQ)	XX (SPQ)	XX (SPQ)	XX (SPQ)	XX (SPQ)	XX (SPQ)	XX (SPQ)	XX (SPQ)	XX (SPQ)	XX (SPQ)	..YYY		
Pitch = 7.62 + 0.30/- 0.40 mm; $d_t = 0.50 \pm 0.05 \text{ mm}$												
0.018 0.022 0.027 0.033 0.039 0.047	2.5 x 6.5 x 10.0	0.24	21... (1000)	22... (1000)	25... (1000)	26... (1000)	68... (2000)	69... (2000)	65... (2000)	66... (2000)	183 223 273 333 393 473	
0.056 0.068 0.082 0.1	3.0 x 8.0 x 10.0	0.34	21... (1000)	22... (1000)	25... (1000)	26... (1000)	68... (1500)	69... (1500)	65... (1500)	66... (1500)	563 683 823 104	
0.12 0.15 0.18 0.22	4.0 x 9.0 x 10.0	0.51	21... (1000)	22... (1000)	25... (1000)	26... (1000)	68... (1000)	69... (1000)	65... (1500)	66... (1500)	124 154 184 224	
0.27 0.33 0.39 0.47	5.0 x 10.5 x 10.0	0.73	21... (1000)	22... (1000)	25... (1000)	26... (1000)	68... (1000)	69... (1000)	65... (1000)	66... (1000)	274 334 394 474	

Note

⁽¹⁾ Weight for short lead products only



$U_{Rdc} = 250\text{ V}$; $U_{Rac} = 160\text{ V}$

C (μF)	DIMENSIONS w x h x l (mm)	MASS (g) ⁽¹⁾	CATALOG NUMBER BFC2 371 XXYYY AND PACKAGING									
			LOOSE IN BOX				AMMOPACK		REEL		C-VALUE	
			$l_t = 4.0 + 1.0/- 0.5\text{ mm}$		$l_t = 26.0 \pm 2.0\text{ mm}$		H = 18.5 mm; P ₀ = 12.7 mm		H = 18.5 mm; P ₀ = 12.7 mm			
			C-tol. = $\pm 10\%$	C-tol. = $\pm 5\%$	C-tol. = $\pm 10\%$	C-tol. = $\pm 5\%$	C-tol. = $\pm 10\%$	C-tol. = $\pm 5\%$	C-tol. = $\pm 10\%$	C-tol. = $\pm 5\%$		
XX (SPQ)	XX (SPQ)	XX (SPQ)	XX (SPQ)	XX (SPQ)	XX (SPQ)	XX (SPQ)	XX (SPQ)	XX (SPQ)	XX (SPQ)	..YYY		
Pitch = 7.62 + 0.30/- 0.40 mm; $d_t = 0.50 \pm 0.05\text{ mm}$												
0.082 0.01 0.012 0.015	2.5 x 6.5 x 10.0	0.24	41... (1000)	42... (1000)	45... (1000)	46... (1000)	78... (2000)	79... (2000)	75... (2000)	76... (2000)	822 103 123 153	
0.018 0.022 0.027 0.033 0.039 0.047	3.0 x 8.0 x 10.0	0.34	41... (1000)	42... (1000)	45... (1000)	46... (1000)	78... (1500)	79... (1500)	75... (1500)	76... (1500)	183 223 273 333 393 473	
0.056 0.068 0.082 0.1	4.0 x 9.0 x 10.0	0.51	41... (1000)	42... (1000)	45... (1000)	46... (1000)	78... (1000)	79... (1000)	75... (1500)	76... (1500)	563 683 823 104	
0.12	5.0 x 10.5 x 10.0	0.73	41... (1000)	42... (1000)	45... (1000)	46... (1000)	78... (1000)	79... (1000)	75... (1000)	76... (1000)	124	

Note

⁽¹⁾ Weight for short lead products only

$U_{Rdc} = 400\text{ V}$; $U_{Rac} = 220\text{ V}$

C (μF)	DIMENSIONS w x h x l (mm)	MASS (g) ⁽¹⁾	CATALOG NUMBER BFC2 371 XXYYY AND PACKAGING									
			LOOSE IN BOX				AMMOPACK		REEL		C-VALUE	
			$l_t = 4.0 + 1.0/- 0.5\text{ mm}$		$l_t = 26.0 \pm 2.0\text{ mm}$		H = 18.5 mm; P ₀ = 12.7 mm		H = 18.5 mm; P ₀ = 12.7 mm			
			C-tol. = $\pm 10\%$	C-tol. = $\pm 5\%$	C-tol. = $\pm 10\%$	C-tol. = $\pm 5\%$	C-tol. = $\pm 10\%$	C-tol. = $\pm 5\%$	C-tol. = $\pm 10\%$	C-tol. = $\pm 5\%$		
XX (SPQ)	XX (SPQ)	XX (SPQ)	XX (SPQ)	XX (SPQ)	XX (SPQ)	XX (SPQ)	XX (SPQ)	XX (SPQ)	XX (SPQ)	..YYY		
Pitch = 7.62 + 0.30/- 0.40 mm; $d_t = 0.50 \pm 0.05\text{ mm}$												
0.0039 0.0047 0.0056 0.0068	2.5 x 6.5 x 10.0	0.24	51... (1000)	52... (1000)	55... (1000)	56... (1000)	88... (2000)	89... (2000)	85... (2000)	86... (2000)	392 472 562 682	
0.0082 0.01	3.0 x 8.0 x 10.0	0.34	51... (1000)	52... (1000)	55... (1000)	56... (1000)	88... (1500)	89... (1500)	85... (1500)	86... (1500)	822 103	
0.012 0.015	4.0 x 9.0 x 10.0	0.51	51... (1000)	52... (1000)	55... (1000)	56... (1000)	88... (1000)	89... (1000)	85... (1500)	86... (1500)	123 153	
0.018 0.022 0.027 0.033 0.039	5.0 x 10.5 x 10.0	0.73	51... (1000)	52... (1000)	55... (1000)	56... (1000)	88... (1000)	89... (1000)	85... (1000)	86... (1000)	183 223 273 333 393	

Note

⁽¹⁾ Weight for short lead products only

MKT 371, MKT 372, MKT 373



Vishay BCcomponents

DC Film Capacitor
MKT Radial Potted Type

COMPOSITION OF CATALOG NUMBER: 372

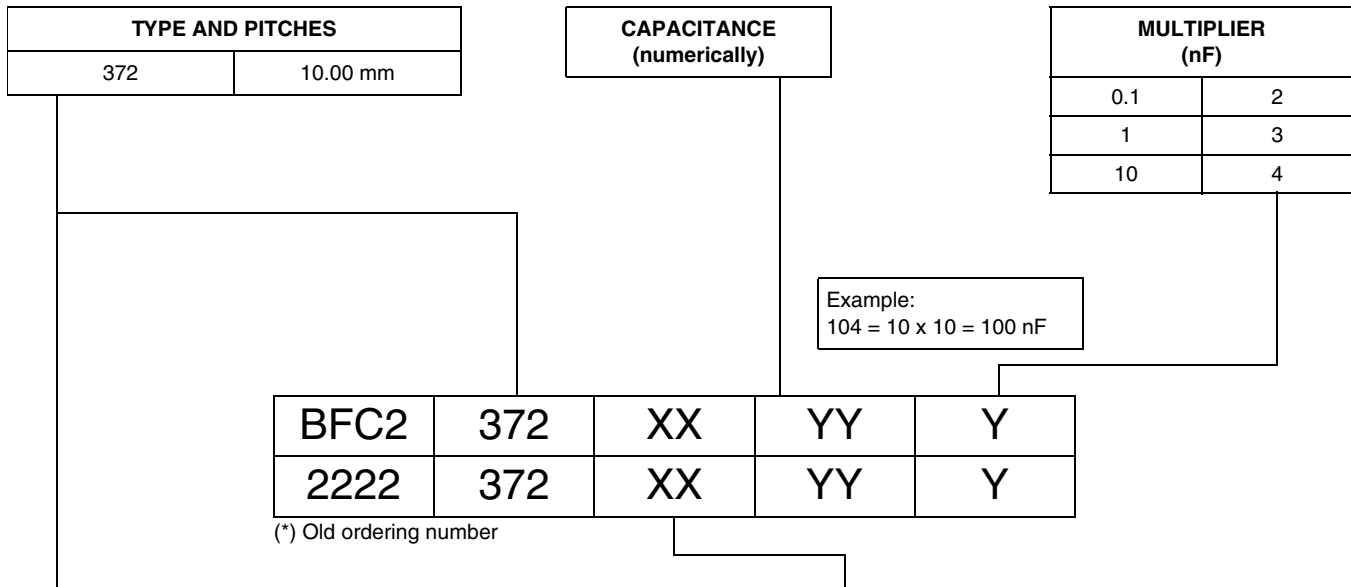

TYPE	PACKAGING	LEAD CONFIGURATION	PREFERRED TYPES				
			C-TOL.	100 V	250 V	400 V	630 V
372	Loose in box	Lead length 4.0 + 1.0/- 0.5 mm	± 10 %	21	41	51	61
			± 5 %	22	42	52	62
	Taped on reel ⁽¹⁾	H ⁽¹⁾ = 18.5 mm P ₀ = 12.7 mm	± 10 %	25	45	55	65
			± 5 %	26	46	56	66
	Ammopack ⁽¹⁾	H ⁽¹⁾ = 18.5 mm P ₀ = 12.7 mm	± 10 %	28	48	58	68
			± 5 %	29	49	59	69

Notes

- ⁽¹⁾ For detailed tape specifications refer to packaging information: www.vishay.com/doc?28139 or end of catalog
⁽²⁾ SPQ = Standard Packing Quantity

SPECIFIC REFERENCE DATA

DESCRIPTION	VALUE					
Tangent of loss angle: C ≤ 0.1 μF 0.1 μF < C ≤ 0.68 μF	at 1 kHz		at 10 kHz		at 100 kHz	
	≤ 75 x 10 ⁻⁴		≤ 130 x 10 ⁻⁴		≤ 250 x 10 ⁻⁴	
	≤ 75 x 10 ⁻⁴		≤ 130 x 10 ⁻⁴		≤ 250 x 10 ⁻⁴	
Rated voltage pulse slope (dU/dt) _R at	100 Vdc	250 Vdc	400 Vdc	630 Vdc		
	34 V/μs	50 V/μs	80 V/μs	120 V/μs		
R between leads, for C ≤ 0.33 μF at 10 V; 1 min at 100 V; 1 min	> 15 000 MΩ	> 15 000 MΩ	> 30 000 MΩ	> 30 000 MΩ		
RC between leads, for C > 0.33 μF at 100 V; 1 min	> 5000 s					
R between interconnecting leads and case (foil method)	> 30 000 MΩ					
Withstanding (DC) voltage (cut off current 10 mA); rise time 100 V/s	160 V; 1 min	400 V; 1 min	640 V; 1 min	1008 V; 1 min		
Withstanding (DC) voltage between leads and case	200 V; 1 min	500 V; 1 min	800 V; 1 min	1260 V; 1 min		
Maximum application temperature	105 °C					



$U_{Rdc} = 100\text{ V}$; $U_{Rac} = 63\text{ V}$

C (μF)	DIMENSIONS w x h x l (mm)	MASS (g) ⁽¹⁾	CATALOG NUMBER BFC2 372 XXYYY AND PACKAGING						C-VALUE ..YYY
			LOOSE IN BOX		REEL		AMMOPACK		
			$l_t = 4.0 + 1.0/- 0.5\text{ mm}$		H = 18.5 mm; $P_0 = 12.7\text{ mm}$		H = 18.5 mm; $P_0 = 12.7\text{ mm}$		
			C-tol. = $\pm 10\%$	C-tol. = $\pm 5\%$	C-tol. = $\pm 10\%$	C-tol. = $\pm 5\%$	C-tol. = $\pm 10\%$	C-tol. = $\pm 5\%$	
			XX (SPQ)	XX (SPQ)	XX (SPQ)	XX (SPQ)	XX (SPQ)	XX (SPQ)	
Pitch = 10.0 \pm 0.4 mm; $d_t = 0.60 \pm 0.06\text{ mm}$									
0.1 0.12 0.15 0.18 0.22 0.27 0.33	4.0 x 10.0 x 12.5	0.65	21... (1000)	22... (1000)	25... (1400)	26... (1400)	28... (750)	29... (750)	104 124 154 184 224 274 334
0.39 0.47	5.0 x 11.0 x 12.5	0.87	21... (1000)	22... (1000)	25... (1100)	26... (1100)	28... (600)	29... (600)	394 474
0.56 0.68	6.0 x 12.0 x 12.5	1.15	21... (750)	22... (750)	25... (900)	26... (900)	28... (500)	29... (500)	564 684

Note

⁽¹⁾ Weight for short lead products only

$U_{Rdc} = 250\text{ V}$; $U_{Rac} = 160\text{ V}$

C (μF)	DIMENSIONS w x h x l (mm)	MASS (g) ⁽¹⁾	CATALOG NUMBER BFC2 372 XXYYY AND PACKAGING						C-VALUE ..YYY
			LOOSE IN BOX		REEL		AMMOPACK		
			$l_t = 4.0 + 1.0/- 0.5\text{ mm}$		H = 18.5 mm; $P_0 = 12.7\text{ mm}$		H = 18.5 mm; $P_0 = 12.7\text{ mm}$		
			C-tol. = $\pm 10\%$	C-tol. = $\pm 5\%$	C-tol. = $\pm 10\%$	C-tol. = $\pm 5\%$	C-tol. = $\pm 10\%$	C-tol. = $\pm 5\%$	
			XX (SPQ)	XX (SPQ)	XX (SPQ)	XX (SPQ)	XX (SPQ)	XX (SPQ)	
Pitch = 10.0 \pm 0.4 mm; $d_t = 0.60 \pm 0.06\text{ mm}$									
0.047 0.056 0.068 0.082 0.1	4.0 x 10.0 x 12.5	0.65	41... (1000)	42... (1000)	45... (1400)	46... (1400)	48... (750)	49... (750)	473 563 683 823 104
0.12 0.15	5.0 x 11.0 x 12.5	0.87	41... (1000)	42... (1000)	45... (1100)	46... (1100)	48... (600)	49... (600)	124 154
0.18 0.22	6.0 x 12.0 x 12.5	1.15	41... (750)	42... (750)	45... (900)	46... (900)	48... (500)	49... (500)	184 224

Note

⁽¹⁾ Weight for short lead products only

MKT 371, MKT 372, MKT 373



Vishay BCcomponents

DC Film Capacitor
MKT Radial Potted Type

$U_{Rdc} = 400\text{ V}$; $U_{Rac} = 220\text{ V}$

C (μF)	DIMENSIONS w x h x l (mm)	MASS (g) ⁽¹⁾	CATALOG NUMBER BFC2 372 XXYYY AND PACKAGING						C-VALUE ..YYY
			LOOSE IN BOX		REEL		AMMOPACK		
			$l_t = 4.0 + 1.0/- 0.5\text{ mm}$		H = 18.5 mm; P ₀ = 12.7 mm		H = 18.5 mm; P ₀ = 12.7 mm		
			C-tol. = $\pm 10\%$	C-tol. = $\pm 5\%$	C-tol. = $\pm 10\%$	C-tol. = $\pm 5\%$	C-tol. = $\pm 10\%$	C-tol. = $\pm 5\%$	
			XX (SPQ)	XX (SPQ)	XX (SPQ)	XX (SPQ)	XX (SPQ)	XX (SPQ)	
Pitch = 10.0 \pm 0.4 mm; d_t = 0.60 \pm 0.06 mm									
0.0047 0.0056 0.0068 0.0082 0.01 0.012 0.015 0.018 0.022 0.027 0.033	4.0 x 10.0 x 12.5	0.65	51... (1000)	52... (1000)	55... (1400)	56... (1400)	58... (750)	59... (750)	472 562 682 822 103 123 153 183 223 273 333
0.039 0.047 0.056	5.0 x 11.0 x 12.5	0.87	51... (1000)	52... (1000)	55... (1100)	56... (1100)	58... (600)	59... (600)	393 473 563
0.068 0.082	6.0 x 12.0 x 12.5	1.15	51... (750)	52... (750)	55... (900)	56... (900)	58... (500)	59... (500)	683 823

Note

⁽¹⁾ Weight for short lead products only

$U_{Rdc} = 630\text{ V}$; $U_{Rac} = 250\text{ V}$

C (μF)	DIMENSIONS w x h x l (mm)	MASS (g) ⁽¹⁾	CATALOG NUMBER BFC2 372 XXYYY AND PACKAGING						C-VALUE ..YYY
			LOOSE IN BOX		REEL		AMMOPACK		
			$l_t = 4.0 + 1.0/- 0.5\text{ mm}$		H = 18.5 mm; P ₀ = 12.7 mm		H = 18.5 mm; P ₀ = 12.7 mm		
			C-tol. = $\pm 10\%$	C-tol. = $\pm 5\%$	C-tol. = $\pm 10\%$	C-tol. = $\pm 5\%$	C-tol. = $\pm 10\%$	C-tol. = $\pm 5\%$	
			XX (SPQ)	XX (SPQ)	XX (SPQ)	XX (SPQ)	XX (SPQ)	XX (SPQ)	
Pitch = 10.0 \pm 0.4 mm; d_t = 0.60 \pm 0.06 mm									
0.01 0.012 0.015 0.018 0.022	4.0 x 10.0 x 12.5	0.65	61... (1000)	62... (1000)	65... (1400)	66... (1400)	68... (750)	69... (750)	103 123 153 183 223
0.027 0.033	5.0 x 11.0 x 12.5	0.87	61... (1000)	62... (1000)	65... (1100)	66... (1100)	68... (600)	69... (600)	273 333
0.039 0.047	6.0 x 12.0 x 12.5	1.15	61... (750)	62... (750)	65... (900)	66... (900)	68... (500)	69... (500)	393 473

Note

⁽¹⁾ Weight for short lead products only



COMPOSITION OF CATALOG NUMBER: 373

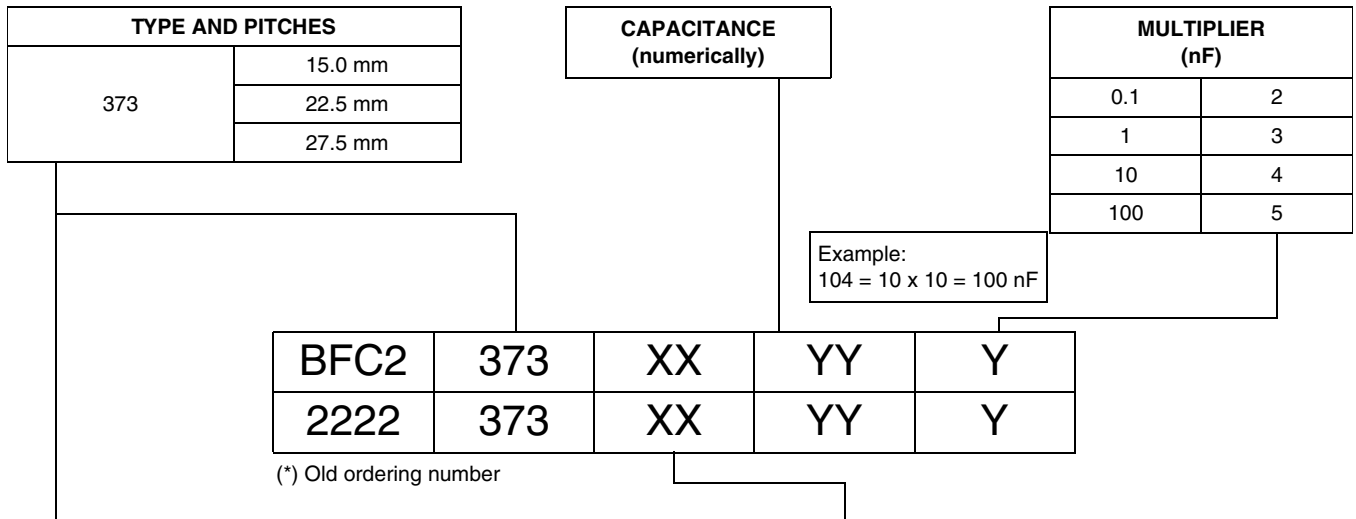

TYPE	PACKAGING	LEAD CONFIGURATION	PREFERRED TYPES				
			C-TOL.	100 V	250 V	400 V	630 V
373 compact	Loose in box	Lead length 5.0 ± 1.0 mm	± 10 %	23	43	53	63
			± 5 %	24	44	54	64
	Taped on reel (1)	H (1) = 18.5 mm P ₀ = 12.7 mm Reel diameter = 356 mm	± 10 %	27	47	57	67
			± 5 %	28	48	58	68
373 standard	Loose in box	Lead length 5.0 ± 1.0 mm	± 10 %	21	41	51	-
			± 5 %	22	42	52	
	Taped on reel (1)	H (1) = 18.5 mm P ₀ = 12.7 mm Reel diameter = 356 mm	± 10 %	25	45	55	
			± 5 %	26	46	56	

Notes

- (1) For detailed tape specifications refer to packaging information: www.vishay.com/doc?28139 or end of catalog
- (2) SPQ = Standard Packing Quantity

SPECIFIC REFERENCE DATA

DESCRIPTION	VALUE			
	at 1 kHz	at 10 kHz	at 100 kHz	
Tangent of loss angle:				
C ≤ 0.1 μF	≤ 75 x 10 ⁻⁴	≤ 130 x 10 ⁻⁴	≤ 250 x 10 ⁻⁴	
0.1 μF < C ≤ 0.47 μF	≤ 75 x 10 ⁻⁴	≤ 130 x 10 ⁻⁴	≤ 300 x 10 ⁻⁴	
0.47 μF < C ≤ 1.0 μF	≤ 75 x 10 ⁻⁴	≤ 130 x 10 ⁻⁴	-	
1.0 μF < C ≤ 10 μF	≤ 75 x 10 ⁻⁴	≤ 150 x 10 ⁻⁴	-	
C > 10 μF	≤ 75 x 10 ⁻⁴	-	-	
Rated voltage pulse slope (dU/dt) _R at P = 15 mm P = 22.5 mm P = 27.5 mm	63 Vdc	100 Vdc	250 Vdc	400 Vdc
	14 V/μs	16 V/μs	34 V/μs	90 V/μs
	5 V/μs	7 V/μs	14 V/μs	35 V/μs
	4 V/μs	6 V/μs	12 V/μs	30 V/μs
R between leads, for C ≤ 0.33 μF at 100 V; 1 min at 500 V; 1 min	> 15 000 MΩ	> 15 000 MΩ	> 30 000 MΩ	> 30 000 MΩ
RC between leads, for C > 0.33 μF at 100 V; 1 min at 500 V; 1 min	> 5000 s	> 10 000 s	> 10 000 s	> 10 000 s
R between interconnecting leads and case (foil method)	> 30 000 MΩ			
Withstanding (DC) voltage (cut off current 10 mA); rise time 100 V/s	160 V; 1 min	400 V; 1 min	640 V; 1 min	1008 V; 1 min
Withstanding (DC) voltage between leads and case	200 V; 1 min	500 V; 1 min	800 V; 1 min	1260 V; 1 min
Maximum application temperature	105 °C			

MKT 371, MKT 372, MKT 373



Vishay BCcomponents

DC Film Capacitor
MKT Radial Potted Type

$U_{Rdc} = 100\text{ V}$; $U_{Rac} = 63\text{ V}$ (standard size)

C (μF)	DIMENSIONS w x h x l (mm)	MASS (g) ⁽¹⁾	CATALOG NUMBER BFC2 373 XXYYY AND PACKAGING				C-VALUE ..YYY
			LOOSE IN BOX		REEL		
			$l_t = 5.0 \pm 1.0\text{ mm}$		$H = 18.5\text{ mm}$; $P_0 = 12.7\text{ mm}$		
			C-tol. = $\pm 10\%$ XX (SPQ)	C-tol. = $\pm 5\%$ XX (SPQ)	C-tol. = $\pm 10\%$ XX (SPQ)	C-tol. = $\pm 5\%$ XX (SPQ)	
Pitch = $15.0 \pm 0.4\text{ mm}$; $d_t = 0.60 \pm 0.06\text{ mm}$							
0.33 0.39 0.47 0.56 0.68 0.82 1 1.2 1.5 1.8	5.0 x 11.0 x 17.5	1.1	23... (1000)	24... (1000)	27... (1100)	28... (1100)	334 394 474 564 684 824 105 125 155 185
2.2	6.0 x 12.0 x 17.5	1.5	23... (1000)	24... (1000)	27... (900)	28... (900)	225
Pitch = $15.0 \pm 0.4\text{ mm}$; $d_t = 0.80 \pm 0.08\text{ mm}$							
2.7 3.3	7.0 x 13.5 x 17.5	2.0	23... (1000)	24... (1000)	27... (800)	28... (800)	275 335
3.9 4.7	8.5 x 15.0 x 17.5	2.7	23... (1000)	24... (1000)	27... (650)	28... (650)	395 475

Note

⁽¹⁾ Weight for short lead products only

$U_{Rdc} = 250\text{ V}$; $U_{Rac} = 160\text{ V}$ (compact size)

C (μF)	DIMENSIONS w x h x l (mm)	MASS (g) ⁽¹⁾	CATALOG NUMBER BFC2 373 XXYYY AND PACKAGING				C-VALUE ..YYY
			LOOSE IN BOX		REEL		
			$l_t = 5.0 \pm 1.0\text{ mm}$		$H = 18.5\text{ mm}$; $P_0 = 12.7\text{ mm}$		
			C-tol. = $\pm 10\%$ XX (SPQ)	C-tol. = $\pm 5\%$ XX (SPQ)	C-tol. = $\pm 10\%$ XX (SPQ)	C-tol. = $\pm 5\%$ XX (SPQ)	
Pitch = $15.0 \pm 0.40\text{ mm}$; $d_t = 0.60 \pm 0.06\text{ mm}$							
0.15 0.18 0.22 0.27 0.32	5.0 x 11.0 x 17.5	1.1	43... (1000)	44... (1000)	47... (1100)	48... (1100)	154 184 224 274 334
0.39 0.47	6.0 x 12.0 x 17.5	1.5	43... (1000)	44... (1000)	47... (900)	48... (900)	394 474
Pitch = $15.0 \pm 0.40\text{ mm}$; $d_t = 0.80 \pm 0.08\text{ mm}$							
0.56 0.68	7.0 x 13.5 x 17.5	2.0	43... (1000)	44... (1000)	47... (800)	48... (800)	564 684
0.82 1	8.5 x 15.0 x 17.5	2.7	43... (1000)	44... (1000)	47... (650)	48... (650)	824 105
1.2	10.0 x 16.5 x 17.5	3.5	43... (500)	44... (500)	47... (600)	48... (600)	125
Pitch = $22.5 \pm 0.4\text{ mm}$; $d_t = 0.80 \pm 0.08\text{ mm}$							
1.5 1.8	8.5 x 18.0 x 26.0	4.5	43... (200)	44... (200)	47... (450)	48... (450)	155 185
2.2 2.7	10.0 x 19.5 x 26.0	5.7	43... (200)	44... (200)	47... (350)	48... (350)	225 275
Pitch = $27.5 \pm 0.4\text{ mm}$; $d_t = 0.80 \pm 0.08\text{ mm}$							
3.3	11.0 x 21.0 x 31.0	8.2	43... (100)	44... (100)	-	-	335
3.9 4.7	13.0 x 23.0 x 31.0	10.2	43... (100)	44... (100)	-	-	395 475

Note

⁽¹⁾ Weight for short lead products only



$U_{Rdc} = 400\text{ V}$; $U_{Rac} = 220\text{ V}$ (compact size)

C (μF)	DIMENSIONS w x h x l (mm)	MASS (g) ⁽¹⁾	CATALOG NUMBER BFC2 373 XXYYY AND PACKAGING				C-VALUE ..YYY
			LOOSE IN BOX		REEL		
			$l_t = 5.0 \pm 1.0\text{ mm}$		H = 18.5 mm; P ₀ = 12.7 mm		
			C-tol. = $\pm 10\%$	C-tol. = $\pm 5\%$	C-tol. = $\pm 10\%$	C-tol. = $\pm 5\%$	
			XX (SPQ)	XX (SPQ)	XX (SPQ)	XX (SPQ)	
Pitch = 15.0 ± 0.4 mm; d_t = 0.60 ± 0.06 mm							
0.047 0.056 0.068 0.082 0.1 0.12 0.15	5.0 x 11.0 x 17.5	1.1	53... (1000)	54... (1000)	57... (1100)	58... (1100)	473 563 683 823 104 124 154
0.18 0.22	6.0 x 12.0 x 17.5	1.5	53... (1000)	54... (1000)	57... (900)	58... (900)	184 224
Pitch = 15.0 ± 0.4 mm; d_t = 0.80 ± 0.08 mm							
0.27 0.33	7.0 x 13.5 x 17.5	2.0	53... (1000)	54... (1000)	57... (800)	58... (800)	274 334
0.39 0.47	8.5 x 15.0 x 17.5	2.7	53... (1000)	54... (1000)	57... (650)	58... (650)	394 474
0.56	10.0 x 16.5 x 17.5	3.5	53... (500)	54... (500)	57... (600)	58... (600)	564
Pitch = 22.5 ± 0.4 mm; d_t = 0.80 ± 0.08 mm							
0.68 0.82	8.5 x 18.0 x 26.0	4.5	53... (200)	54... (200)	57... (450)	58... (450)	684 824
1 1.2	10.0 x 19.5 x 26.0	5.7	53... (200)	54... (200)	57... (350)	58... (350)	105 125
Pitch = 27.5 ± 0.4 mm; d_t = 0.80 ± 0.08 mm							
1.5	11.0 x 21.0 x 31.0	8.2	53... (100)	54... (100)	-	-	155
1.8 2.2	13.0 x 23.0 x 31.0	10.2	53... (100)	54... (100)	-	-	185 225

Note

⁽¹⁾ Weight for short lead products only

MKT 371, MKT 372, MKT 373



Vishay BCcomponents

DC Film Capacitor
MKT Radial Potted Type

$U_{Rdc} = 630\text{ V}$; $U_{Rac} = 250\text{ V}$ (compact size)

C (μF)	DIMENSIONS w x h x l (mm)	MASS (g) ⁽¹⁾	CATALOG NUMBER BFC2 373 XXYYY AND PACKAGING				
			LOOSE IN BOX		REEL		C-VALUE
			$l_t = 5.0 \pm 1.0\text{ mm}$		H = 18.5 mm; P ₀ = 12.7 mm		
			C-tol. = $\pm 10\%$	C-tol. = $\pm 5\%$	C-tol. = $\pm 10\%$	C-tol. = $\pm 5\%$	
			XX (SPQ)	XX (SPQ)	XX (SPQ)	XX (SPQ)	..YYY
Pitch = 15.0 ± 0.4 mm; d_t = 0.60 ± 0.06 mm							
0.047 0.056	5.0 x 11.0 x 17.5	1.1	63... (1000)	64... (1000)	67... (1100)	68... (1100)	473 563
0.068 0.082	6.0 x 12.0 x 17.5	1.5	63... (1000)	64... (1000)	67... (900)	68... (900)	683 823
Pitch = 15.0 ± 0.4 mm; d_t = 0.80 ± 0.08 mm							
0.1 0.12	7.0 x 13.5 x 17.5	2.0	63... (1000)	64... (1000)	67... (800)	68... (800)	104 124
0.15 0.18	8.5 x 15.0 x 17.5	2.7	63... (1000)	64... (1000)	67... (650)	68... (650)	154 184
0.22	10.0 x 16.5 x 17.5	3.5	63... (500)	64... (500)	67... (600)	68... (600)	224
Pitch = 22.5 ± 0.4 mm; d_t = 0.80 ± 0.08 mm							
0.27 0.33	8.5 x 18.0 x 26.0	4.5	63... (200)	64... (200)	67... (450)	68... (450)	274 334
0.39 0.47	10.0 x 19.5 x 26.0	5.7	63... (200)	64... (200)	67... (350)	68... (350)	394 474
Pitch = 27.5 ± 0.4 mm; d_t = 0.80 ± 0.08 mm							
0.56	11.0 x 21.0 x 31.0	8.2	63... (100)	64... (100)	-	-	564
0.68 0.82	13.0 x 23.0 x 31.0	10.2	63... (100)	64... (100)			684 824
1	15.0 x 25.0 x 31.0	13.4	63... (100)	64... (100)			105

Note

(1) Weight for short lead products only



U_{Rdc} = 100 V; U_{Rac} = 63 V (standard size)

C (µF)	DIMENSIONS w x h x l (mm)	MASS (g) ⁽¹⁾	CATALOG NUMBER BFC2 373 XXYYY AND PACKAGING					
			LOOSE IN BOX			REEL		C-VALUE
			l _t = 5.0 ± 1.0 mm			H = 18.5 mm; P ₀ = 12.7 mm		
			C-tol. = ± 10 %	C-tol. = ± 5 %	SPQ	C-tol. = ± 10 %	C-tol. = ± 5 %	
XX (SPQ)	XX (SPQ)	XX (SPQ)	XX (SPQ)	XX (SPQ)	..YYY			
Pitch = 15.0 ± 0.4 mm; d_t = 0.60 ± 0.06 mm								
0.33 0.39 0.47 0.56 0.68	5.0 x 11.0 x 17.5	1.1	21... (1000)	22... (1000)	25... (1100)	26... (1100)	334 394 474 565 684	
0.82 1	6.0 x 12.0 x 17.5	1.5	21... (1000)	22... (1000)	25... (900)	26... (900)	824 105	
Pitch = 15.0 ± 0.4 mm; d_t = 0.80 ± 0.08 mm								
1.2 1.5	7.0 x 13.5 x 17.5	2.0	21... (1000)	22... (1000)	25... (800)	26... (800)	125 155	
1.8 2.2	8.5 x 15.0 x 17.5	2.7	21... (1000)	22... (1000)	25... (650)	26... (650)	185 225	
Pitch = 22.5 ± 0.4 mm; d_t = 0.80 ± 0.08 mm								
2.7 3.3	8.5 x 18.0 x 26.0	4.5	21... (200)	22... (200)	25... (450)	26... (450)	275 335	
3.9 4.7	10.0 x 19.5 x 26.0	5.7	21... (200)	22... (200)	25... (350)	26... (350)	395 475	
Pitch = 27.5 ± 0.4 mm; d_t = 0.80 ± 0.08 mm								
5.6 6.8	11.0 x 21.0 x 31.0	8.2	21... (100)	22... (100)	-	-	565 685	
8.2 10	13.0 x 23.0 x 31.0	10.2	21... (100)	22... (100)	-	-	825 106	
12 15	15.0 x 25.0 x 31.0	18.4	21... (100)	22... (100)	-	-	126 156	

Note

⁽¹⁾ Weight for short lead products only

Available on request

C (µF)	DIMENSIONS w x h x l (mm)	MASS (g) ⁽¹⁾	CATALOG NUMBER BFC2 373 XXYYY AND PACKAGING					
			LOOSE IN BOX			REEL		
			l _t = 5.0 ± 1.0 mm			H = 18.5 mm		
			C-tol. = ± 10 %	C-tol. = ± 5 %	SPQ	C-tol. = ± 10 %	C-tol. = ± 5 %	SPQ
Pitch = 22.5 ± 0.4 mm; d_t = 0.80 ± 0.08 mm								
1.5	6.0 x 15.5 x 26.0	2.7	90012	90013	300	90018	90019	600
1.8 2.2	7.0 x 16.5 x 26.0	3.3	90022 90002	90023 90003	200	90028 90008	90029 90009	550
Pitch = 27.5 ± 0.4 mm; d_t = 0.80 ± 0.08 mm								
4.7	9.0 x 19.0 x 31.0	6.1	90032	90033	100	-		

Note

⁽¹⁾ Weight for short lead products only

MKT 371, MKT 372, MKT 373



Vishay BCcomponents

DC Film Capacitor
MKT Radial Potted Type

$U_{Rdc} = 250\text{ V}$; $U_{Rac} = 160\text{ V}$ (standard size)

C (μF)	DIMENSIONS w x h x l (mm)	MASS (g) ⁽¹⁾	CATALOG NUMBER BFC2 373 XXYYY AND PACKAGING					
			LOOSE IN BOX			REEL		C-VALUE
			$l_t = 5.0 \pm 1.0\text{ mm}$			$H = 18.5\text{ mm}$; $P_0 = 12.7\text{ mm}$		
			C-tol. = $\pm 10\%$	C-tol. = $\pm 5\%$	SPQ	C-tol. = $\pm 10\%$	C-tol. = $\pm 5\%$	
Pitch = $15.0 \pm 0.4\text{ mm}$; $d_t = 0.60 \pm 0.06\text{ mm}$								
0.15 0.18 0.22	5.0 x 11.0 x 17.5	1.1	41... (1000)	42... (1000)	45... (1100)	46... (1100)	154 184 224	
0.27 0.33 0.39 0.47	6.0 x 12.0 x 17.5	1.5	41... (1000)	42... (1000)	45... (900)	46... (900)	274 334 394 474	
Pitch = $15.0 \pm 0.4\text{ mm}$; $d_t = 0.80 \pm 0.08\text{ mm}$								
0.56 0.68	7.0 x 13.5 x 17.5	2.0	41... (1000)	42... (1000)	45... (800)	46... (800)	564 684	
0.82 1	8.5 x 15.0 x 17.5	2.7	41... (1000)	42... (1000)	45... (650)	46... (650)	824 105	
Pitch = $22.5 \pm 0.4\text{ mm}$; $d_t = 0.80 \pm 0.08\text{ mm}$								
1.2 1.5	8.5 x 18.0 x 26.0	4.5	41... (200)	42... (200)	45... (450)	46... (450)	125 155	
1.8 2.2	10.0 x 19.5 x 26.0	5.7	41... (200)	42... (200)	45... (350)	46... (350)	185 225	
Pitch = $27.5 \pm 0.4\text{ mm}$; $d_t = 0.80 \pm 0.08\text{ mm}$								
2.7 3.3	13.0 x 23.0 x 31.0	10.2	41... (100)	42... (100)	-	-	275 335	
3.9 4.7	15.0 x 28.0 x 31.0	13.4	41... (100)	42... (100)	-	-	395 475	

Note

⁽¹⁾ Weight for short lead products only

Available on request

C (μF)	DIMENSIONS w x h x l (mm)	MASS (g) ⁽¹⁾	CATALOG NUMBER BFC2 373 XXYYY AND PACKAGING					
			LOOSE IN BOX			REEL		
			$l_t = 5.0 \pm 1.0\text{ mm}$			$H = 18.5\text{ mm}$		
			C-tol. = $\pm 10\%$	C-tol. = $\pm 5\%$	SPQ	C-tol. = $\pm 10\%$	C-tol. = $\pm 5\%$	SPQ
Pitch = $22.5 \pm 0.4\text{ mm}$; $d_t = 0.80 \pm 0.08\text{ mm}$								
0.47 0.56 0.67	6.0 x 15.5 x 26.0	2.7	90042 90052 90062	90046 90053 90063	300	90048 90058 90068	90049 90059 90069	600
0.85 1	7.0 x 16.5 x 26.0	3.3	90072 90082	90073 90083	200	90078 90088	90079 90089	550
Pitch = $27.5 \pm 0.4\text{ mm}$; $d_t = 0.80 \pm 0.08\text{ mm}$								
1.2 1.5	9.0 x 19.0 x 31.0	6.1	90172 90092	90173 90093	100	-	-	-
1.8 2.2	9.0 x 21.0 x 31.0	8.2	90102 90112	90103 90113	100	-	-	-

Note

⁽¹⁾ Weight for short lead products only



$U_{Rdc} = 400\text{ V}$; $U_{Rac} = 220\text{ V}$ (standard size)

C (μF)	DIMENSIONS w x h x l (mm)	MASS (g) ⁽¹⁾	CATALOG NUMBER BFC2 373 XXYYY AND PACKAGING					C-VALUE
			LOOSE IN BOX			REEL		
			$l_t = 5.0 \pm 1.0\text{ mm}$			$H = 18.5\text{ mm}$; $P_0 = 12.7\text{ mm}$		
			C-tol. = $\pm 10\%$	C-tol. = $\pm 5\%$		C-tol. = $\pm 10\%$	C-tol. = $\pm 5\%$	
			XX (SPQ)	XX (SPQ)		XX (SPQ)	XX (SPQ)	
Pitch = $15.0 \pm 0.4\text{ mm}$; $d_t = 0.60 \pm 0.06\text{ mm}$								
0.047 0.056 0.068 0.082 0.1	5.0 x 11.0 x 17.5	1.1	51... (1000)	52... (1000)		55... (1100)	56... (1100)	473 563 683 823 104
0.12 0.15	6.0 x 12.0 x 17.5	1.5	51... (1000)	52... (1000)		55... (900)	56... (900)	124 154
Pitch = $15.0 \pm 0.4\text{ mm}$; $d_t = 0.80 \pm 0.08\text{ mm}$								
0.18 0.22	7.0 x 13.5 x 17.5	2.0	51... (1000)	52... (1000)		55... (800)	56... (800)	184 224
0.27 0.33	8.5 x 15.0 x 17.5	2.7	51... (1000)	52... (1000)		55... (650)	56... (650)	274 334
Pitch = $22.5 \pm 0.4\text{ mm}$; $d_t = 0.80 \pm 0.08\text{ mm}$								
0.39 0.47	8.5 x 18.0 x 26.0	4.5	51... (200)	52... (200)		55... (450)	56... (450)	394 474
0.56 0.68	10.0 x 19.5 x 26.0	5.7	51... (200)	52... (200)		55... (350)	56... (350)	564 684
Pitch = $27.5 \pm 0.4\text{ mm}$; $d_t = 0.80 \pm 0.08\text{ mm}$								
0.82 1	13.0 x 23.0 x 31.0	10.2	51... (100)	52... (100)				824 105
1.2 1.5	15.0 x 28.0 x 31.0	13.4	51... (100)	52... (100)				125 155

Note

⁽¹⁾ Weight for short lead products only

Available on request

C (μF)	DIMENSIONS w x h x l (mm)	MASS (g) ⁽¹⁾	CATALOG NUMBER BFC2 373 XXYYY AND PACKAGING					
			LOOSE IN BOX			REEL		
			$l_t = 5.0 \pm 1.0\text{ mm}$			$H = 18.5\text{ mm}$		
			C-tol. = $\pm 10\%$	C-tol. = $\pm 5\%$	SPQ	C-tol. = $\pm 10\%$	C-tol. = $\pm 5\%$	SPQ
			Pitch = $22.5 \pm 0.4\text{ mm}$; $d_t = 0.80 \pm 0.08\text{ mm}$					
0.22	6.0 x 15.5 x 26.0	2.7	90122	90123	300	90128	90129	600
0.27 0.33	7.0 x 16.5 x 26.0	3.3	90132 90142	90133 90143	200	90138 90148	90139 90149	550
Pitch = $27.5 \pm 0.4\text{ mm}$; $d_t = 0.80 \pm 0.08\text{ mm}$								
0.68	9.0 x 19.0 x 31.0	6.1	90152	90153	100			-

Note

⁽¹⁾ Weight for short lead products only

MOUNTING

Normal Use

The capacitors are designed for mounting on printed-circuit boards. The capacitors packed in bandoliers are designed for mounting in printed-circuit boards by means of automatic insertion machines.

For detailed tape specifications refer to packaging information: www.vishay.com/doc?28139 or end of catalog.

Specific Method of Mounting to Withstand Vibration and Shock

In order to withstand vibration and shock tests, it must be ensured that stand-off pips are in good contact with the printed-circuit board.

- For $L \leq 15$ mm capacitors shall be mechanically fixed by the leads
- For larger pitches the capacitors shall be mounted in the same way and the body clamped

Space Requirements On Printed-Circuit Board

The maximum length and width of film capacitors is shown in the drawing:

- Eccentricity as in drawing. The maximum eccentricity is smaller than or equal to the lead diameter of the product concerned.
- Product height with seating plane as given by "IEC 60717" as reference: $h_{\max.} \leq h + 0.3$ mm

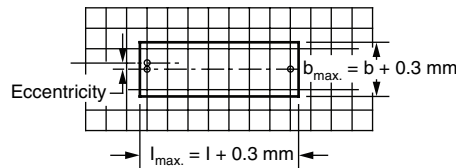

Storage Temperature

- Storage temperature: $T_{\text{stg}} = -25$ °C to $+40$ °C with RH maximum 80 % without condensation

Ratings and Characteristics Reference Conditions

Unless otherwise specified, all electrical values apply to an ambient free air temperature of 23 ± 1 °C, an atmospheric pressure of 86 kPa to 106 kPa and a relative humidity of 50 ± 2 %.

For reference testing, a conditioning period shall be applied over 96 ± 4 h by heating the products in a circulating air oven at the rated temperature and a relative humidity not exceeding 20 %.



CHARACTERISTICS

371, 372, 373 - Capacitance as a function of frequency

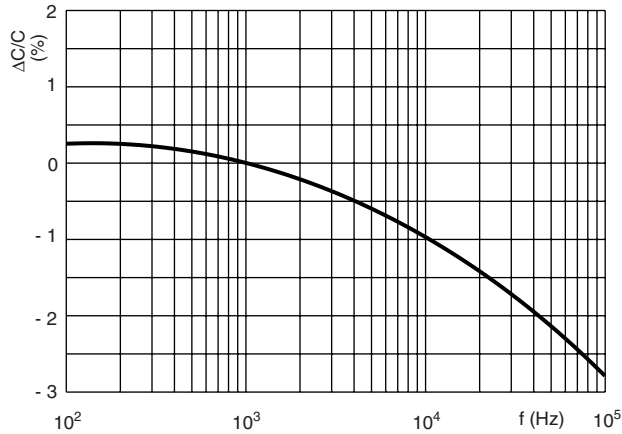

371 - Capacitance as a function of ambient temperature

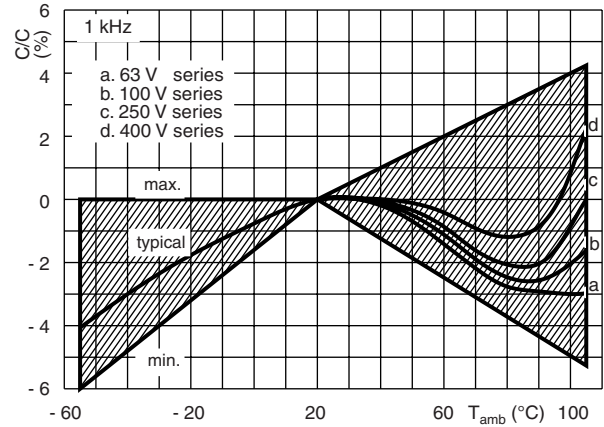

372, 373 - Capacitance as a function of ambient temperature

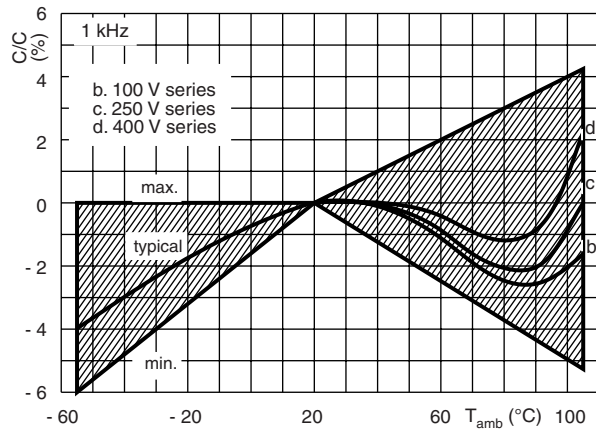

371, 372, 373 - Max. DC and AC Voltage as a function of temperature

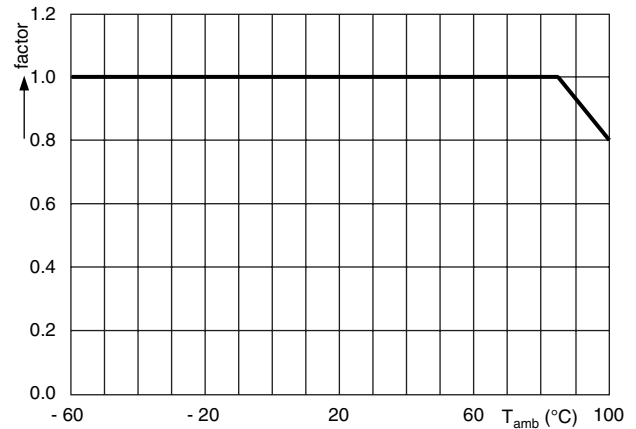

371 - Impedance as a function of frequency

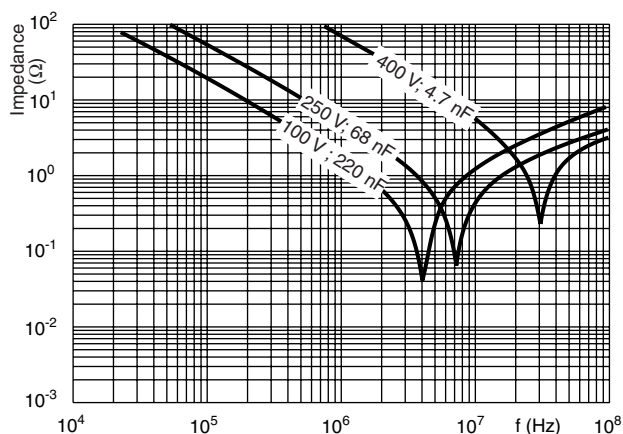

372 - Impedance as a function of frequency

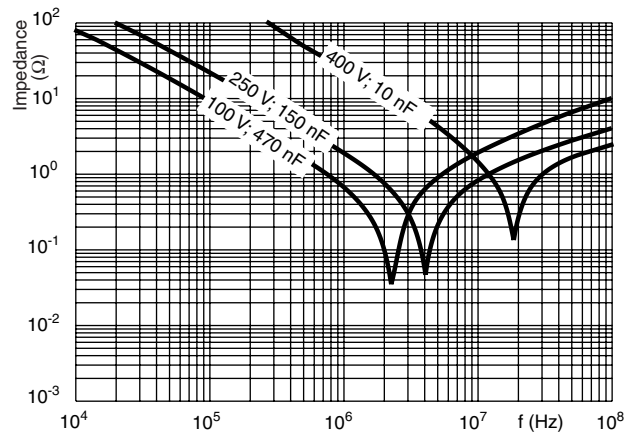

373 - Impedance as a function of frequency

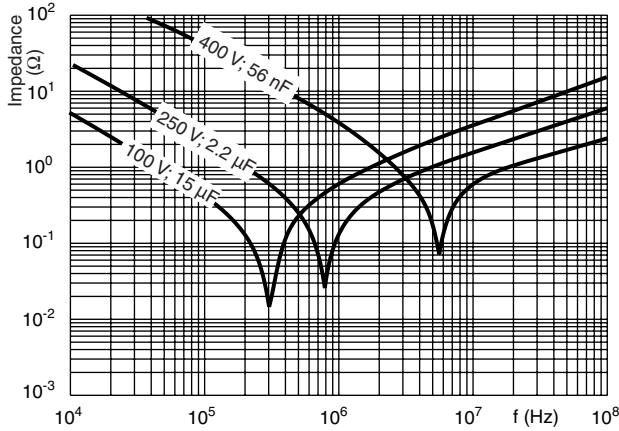

371 - Max. AC voltage as a function of temperature

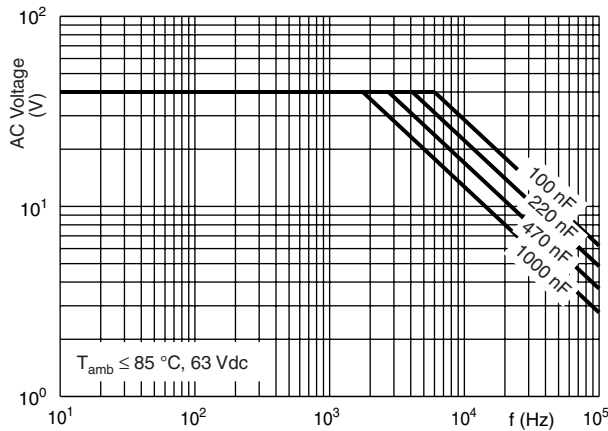

371 - Max. AC voltage as a function of frequency

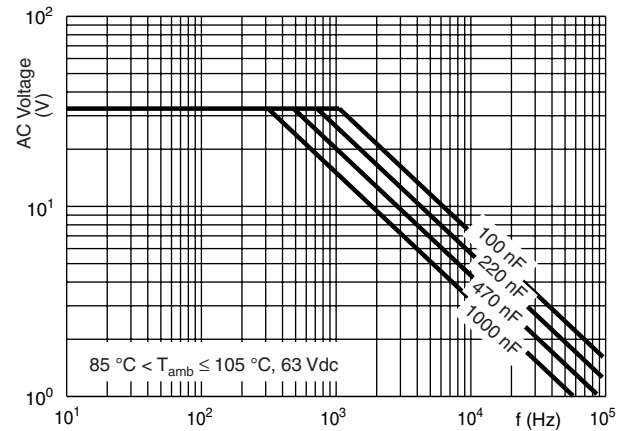

371 - Max. AC voltage as a function of frequency

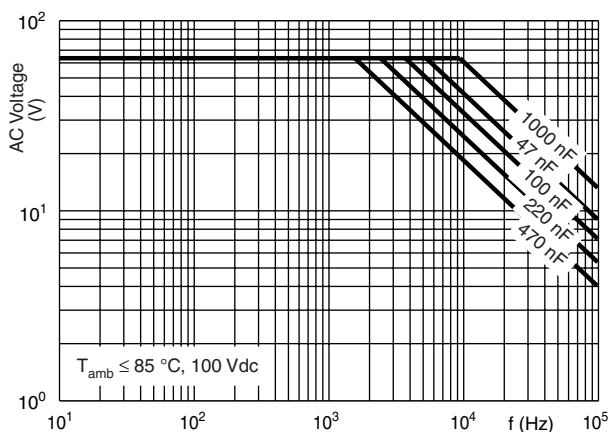

371 - Max. AC voltage as a function of frequency

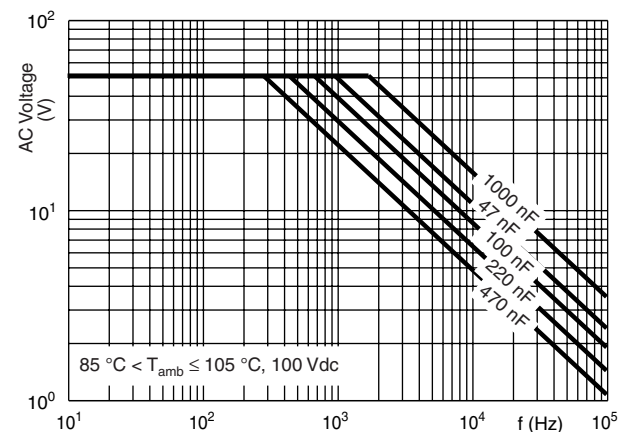



371 - Max. AC voltage as a function of frequency

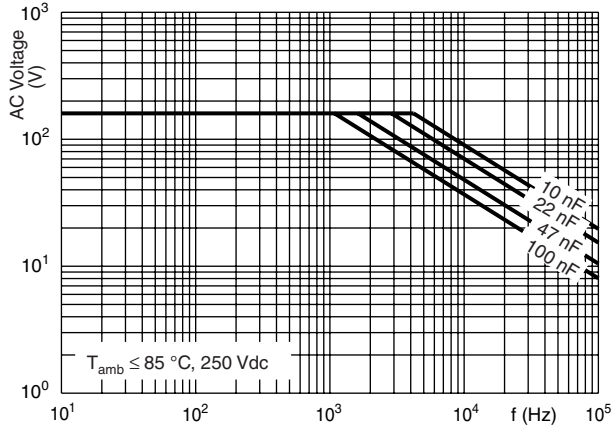

371 - Max. AC voltage as a function of frequency

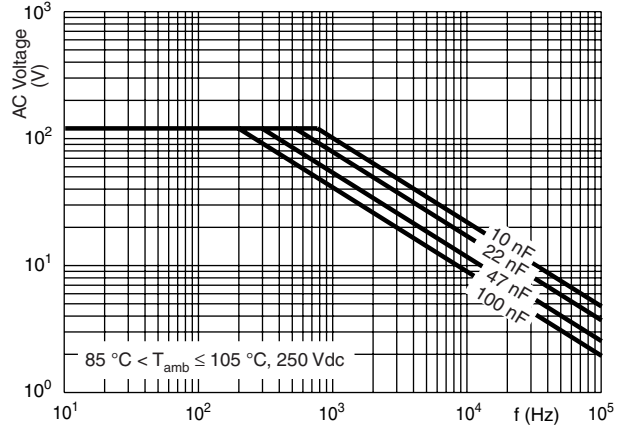

371 - Max. AC voltage as a function of frequency

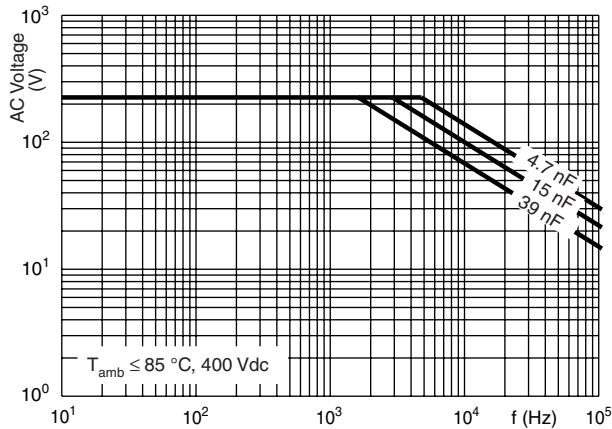

371 - Max. AC voltage as a function of frequency

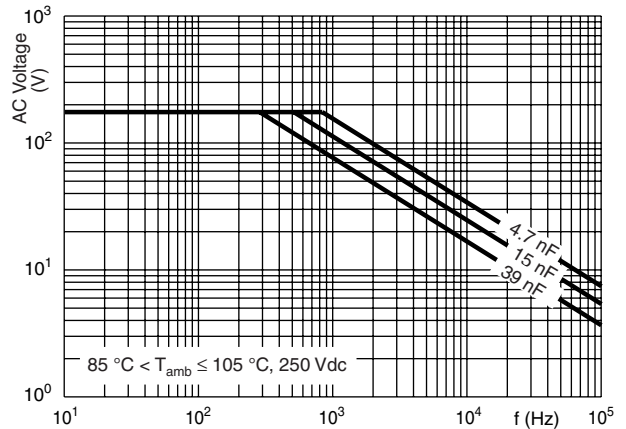

372 - Max. AC voltage as a function of temperature

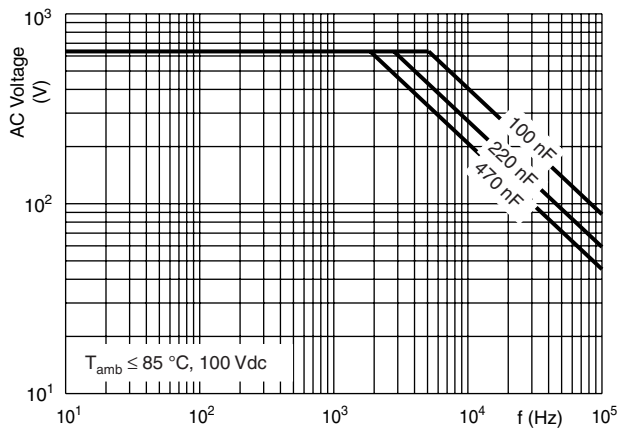

373 - Max. AC voltage as a function of temperature

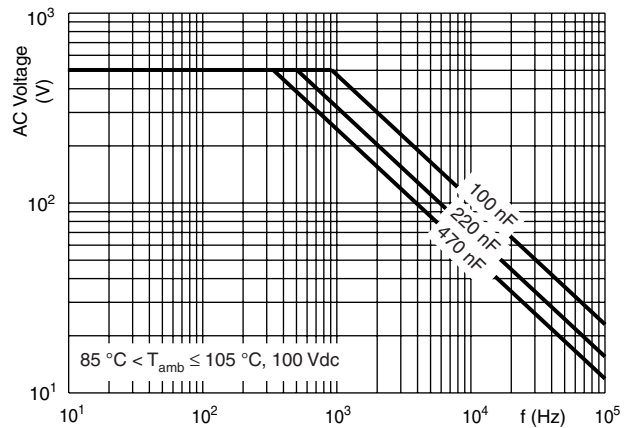

374 - Max. AC voltage as a function of frequency

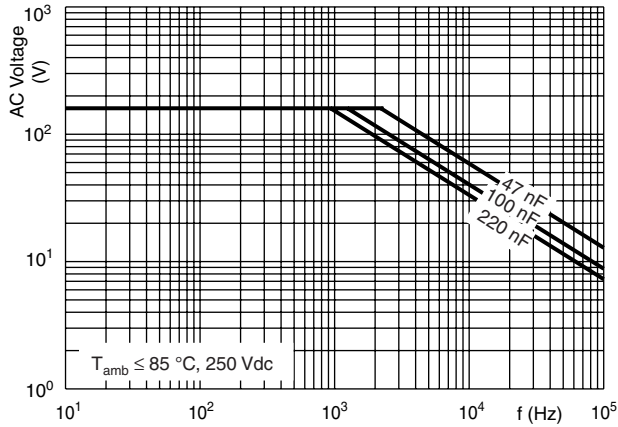

375 - Max. AC voltage as a function of frequency

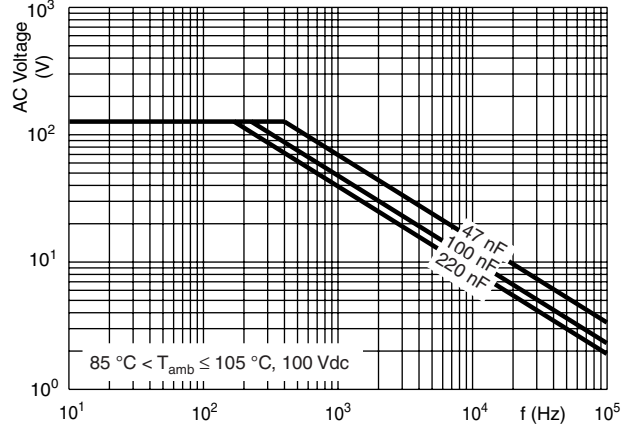

376 - Max. AC voltage as a function of frequency

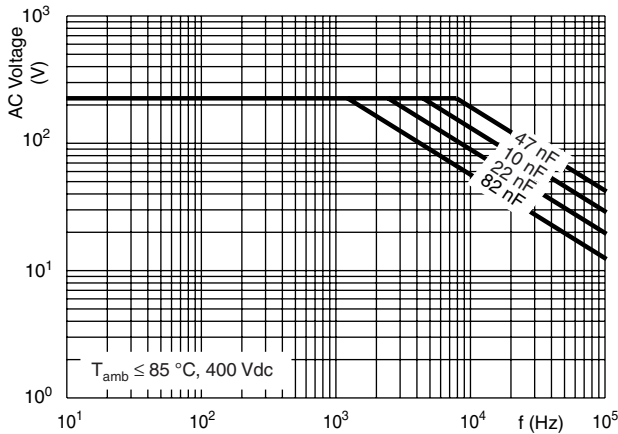

377 - Max. AC voltage as a function of frequency

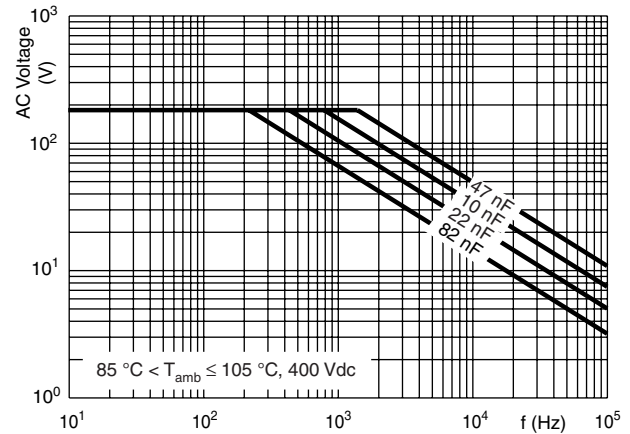

378 - Max. AC voltage as a function of frequency

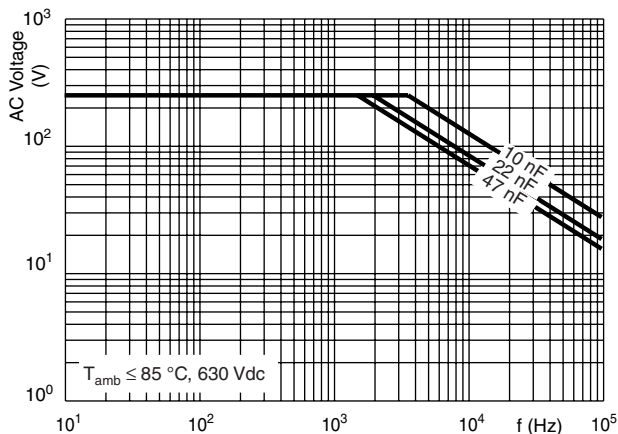

379 - Max. AC voltage as a function of frequency

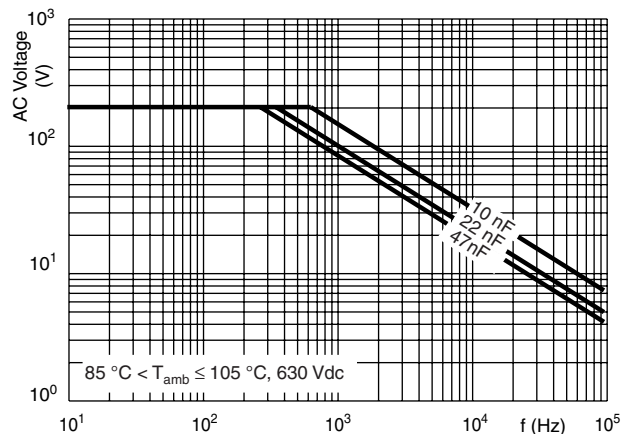



373 - Max. AC voltage as a function of temperature

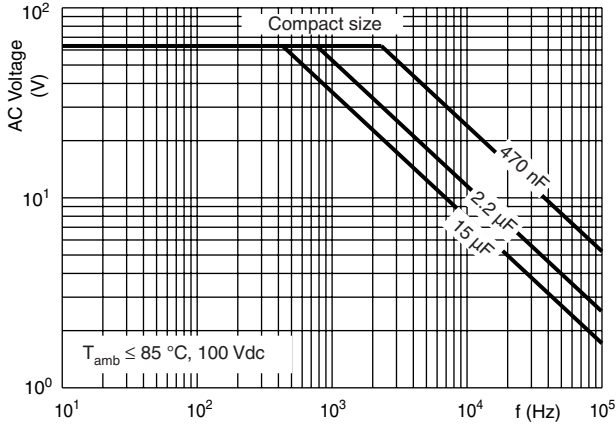

373 - Max. AC voltage as a function of frequency

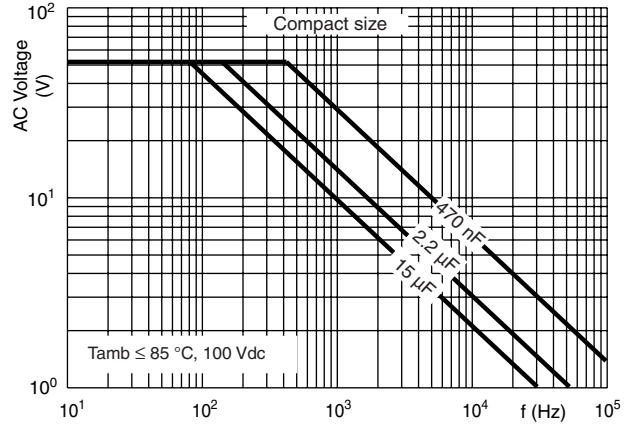

373 - Max. AC voltage as a function of frequency

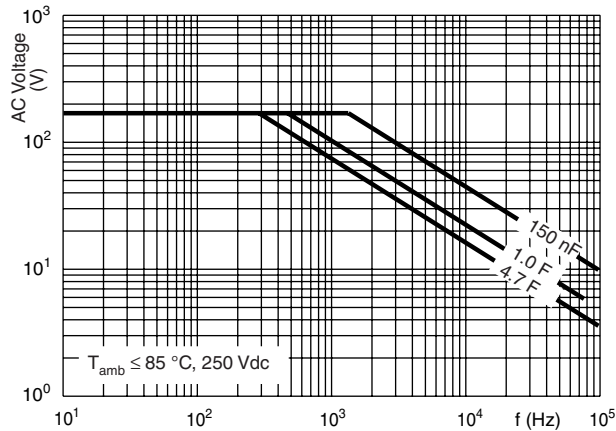

373 - Max. AC voltage as a function of frequency

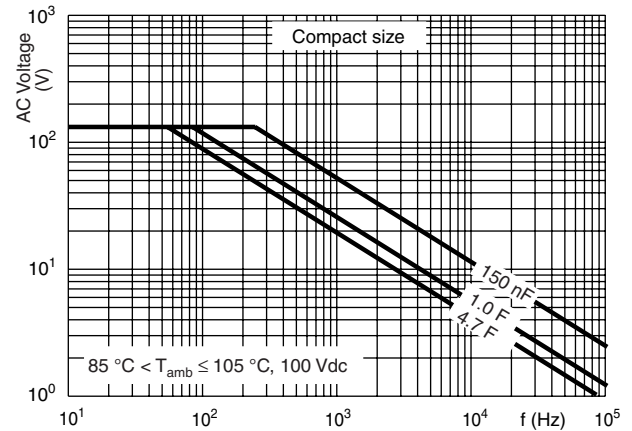

373 - Max. AC voltage as a function of frequency

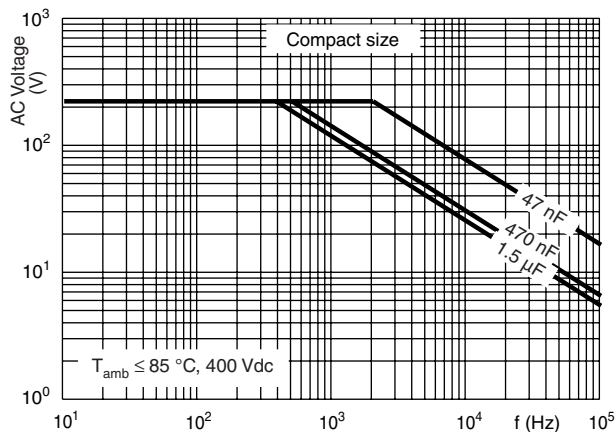

373 - Max. AC voltage as a function of frequency

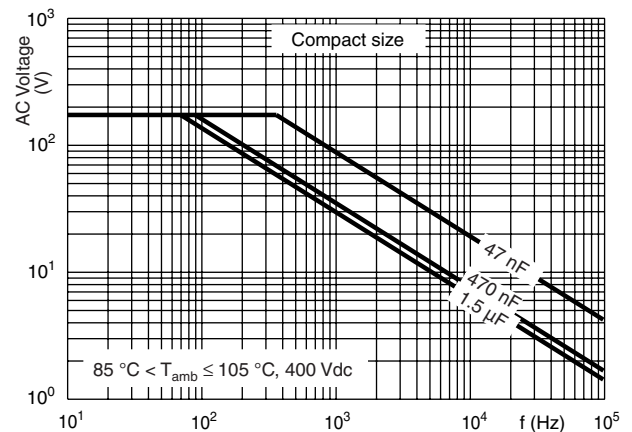



373 - Max. AC voltage as a function of frequency

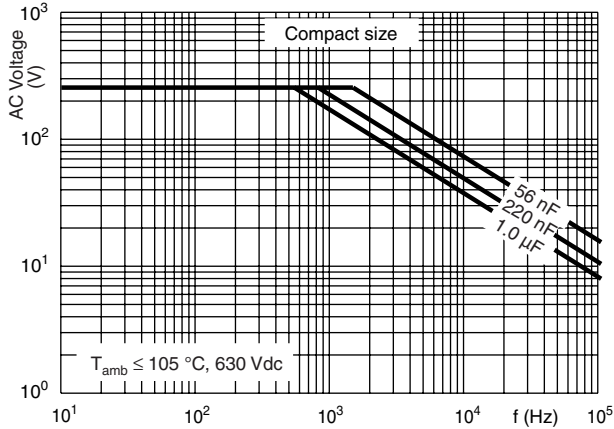

373 - Max. AC voltage as a function of frequency

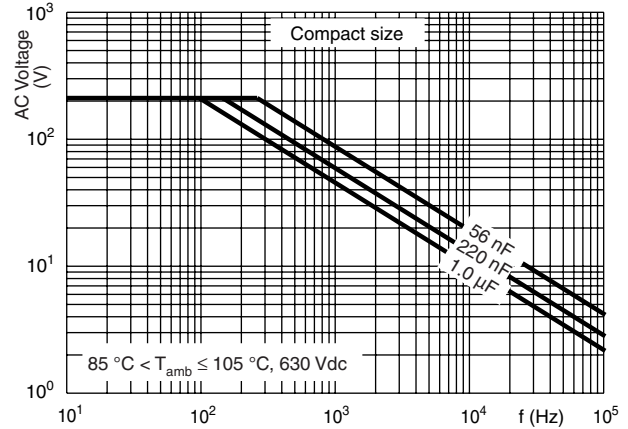

373 - Max. AC voltage as a function of frequency

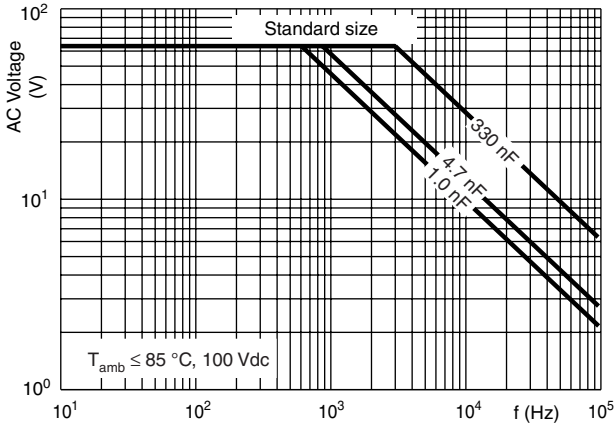

373 - Max. AC voltage as a function of frequency

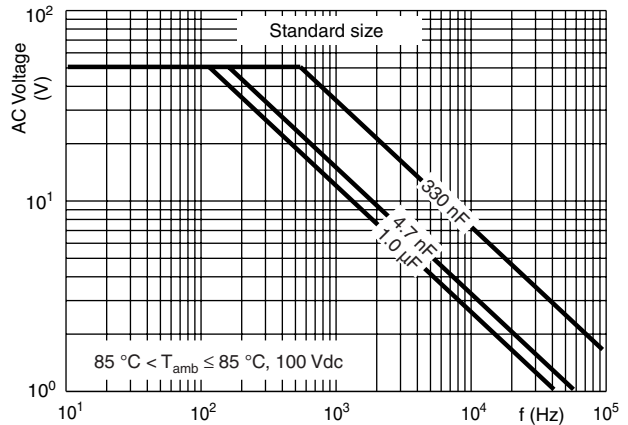

373 - Max. AC voltage as a function of frequency

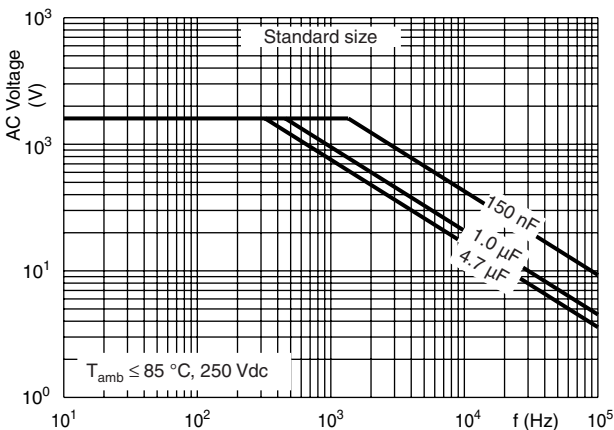

373 - Max. AC voltage as a function of frequency

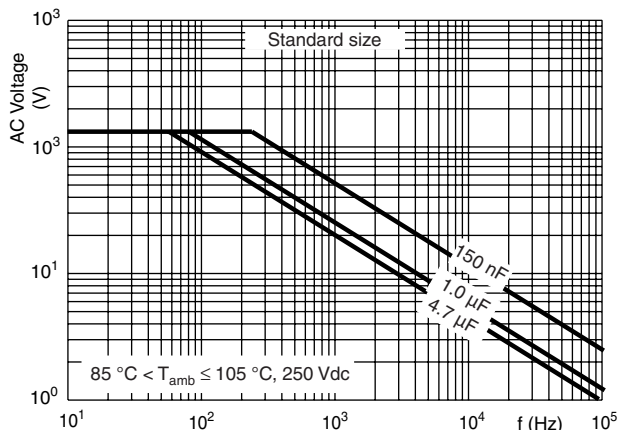



373 - Max. AC voltage as a function of frequency

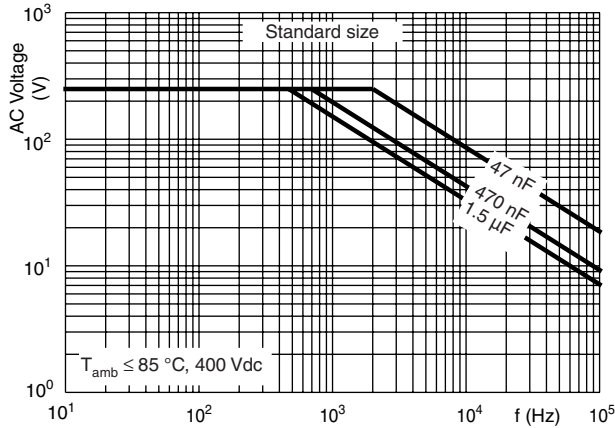

373 - Max. AC voltage as a function of frequency

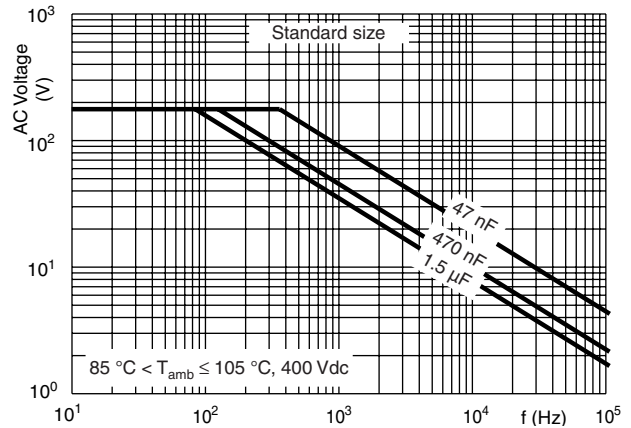

Maximum RMS current (sinewave) as a function of frequency

U_{ac} is the maximum AC voltage depending on the ambient temperature in the curves "Max. RMS voltage and AC current as a function of frequency".

371, 372, 373 - Tangent of loss angle as a function of frequency

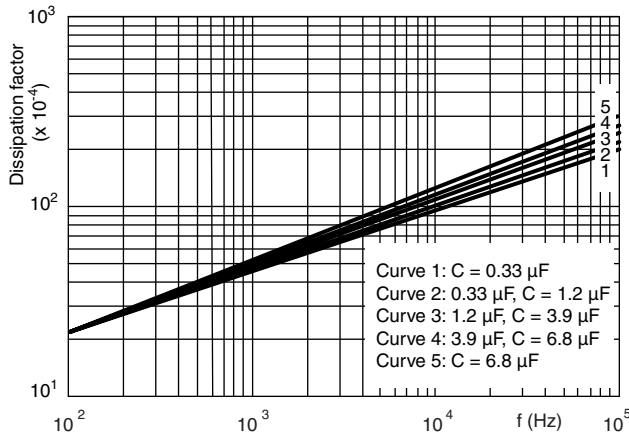

371, 372, 373 - Insulation resistance as a function of the ambient temperature (typical curve)

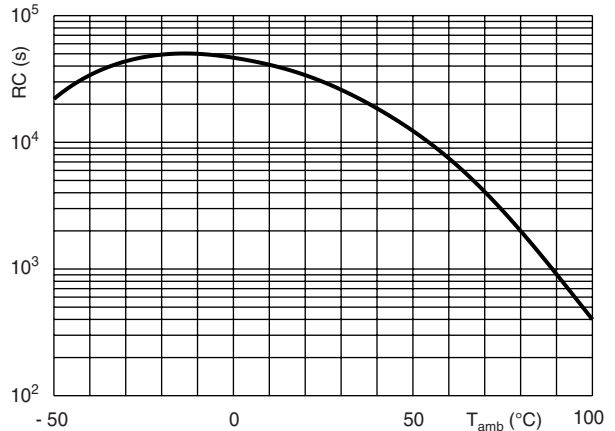

Maximum allowed component temperature rise (DT) as a function of the ambient temperature T_{amb} (°C)

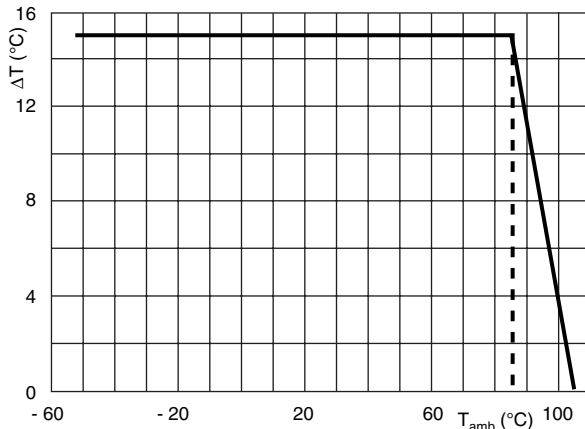

HEAT CONDUCTIVITY (G) AS A FUNCTION OF (ORIGINAL) PITCH AND CAPACITOR BODY THICKNESS IN mW/°C

W _{max.} (mm)	HEAT CONDUCTIVITY (mW/°C)				
	PITCH 7.62 mm	PITCH 10.0 mm	PITCH 15.0 mm	PITCH 22.5 mm	PITCH 27.5 mm
2.5	3	-	-	-	-
3.0	4	-	-	-	-
3.5	-	-	-	-	-
4.0	5	6.0	-	-	-
4.5	-	-	-	-	-
5.0	6	7.5	10	-	-
6.0	7	9.0	11	19	-
7.0	-	-	12	21	-
8.5	-	-	16	25	-
10.0	-	-	18	28	-
11.0	-	-	-	-	36
13.0	-	-	-	-	42
15.0	-	-	-	-	48
18.0	-	-	-	-	57

POWER DISSIPATION AND MAXIMUM COMPONENT TEMPERATURE RISE

The power dissipation must be limited in order not to exceed the maximum allowed component temperature rise as a function of the free ambient temperature.

The power dissipation can be calculated according type detail specification “HQN-384-01/101: Technical Information Film Capacitors”.

The component temperature rise (ΔT) can be measured (see section “Measuring the component temperature” for more details) or calculated by $\Delta T = P/G$:

- ΔT = Component temperature rise (°C)
- P = Power dissipation of the component (mW)
- G = Heat conductivity of the component (mW/°C)

MEASURING THE COMPONENT TEMPERATURE

A thermocouple must be attached to the capacitor body as in:

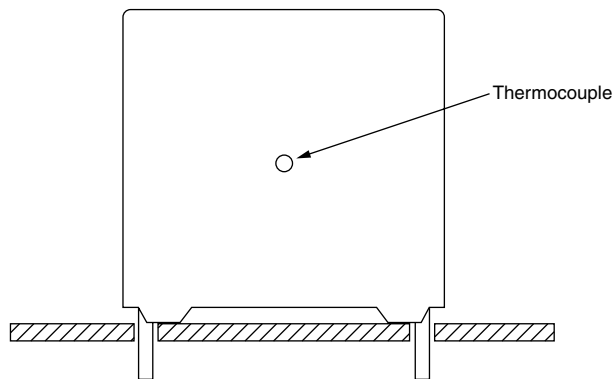

The temperature is measured in unloaded (T_{amb}) and maximum loaded condition (T_C).

The temperature rise is given by $\Delta T = T_C - T_{amb}$.

To avoid radiation or convection, the capacitor should be tested in a wind-free box.

APPLICATION NOTE AND LIMITING CONDITIONS

These capacitors are not suitable for mains applications as across-the-line capacitors without additional protection, as described hereunder. These mains applications are strictly regulated in safety standards and therefore electromagnetic interference suppression capacitors conforming the standards must be used.

To select the capacitor for a certain application, the following conditions must be checked:

1. The peak voltage (U_P) shall not be greater than the rated DC voltage (U_{Rdc})
2. The peak-to-peak voltage (U_{P-P}) shall not be greater than $2\sqrt{2} \times U_{Rac}$ to avoid the ionisation inception level
3. The voltage peak slope (dU/dt) shall not exceed the rated voltage pulse slope in an RC-circuit at rated voltage and without ringing. If the pulse voltage is lower than the rated DC voltage, the rated voltage pulse slope may be multiplied by U_{Rdc} and divided by the applied voltage.

For all other pulses following equation must be fulfilled:

$$2 \times \int_0^T \left(\frac{dU}{dt} \right)^2 \times dt < U_{Rdc} \times \left(\frac{dU}{dt} \right)_{rated}$$

T is the pulse duration.

4. The maximum component surface temperature rise must be lower than the limits (see graph max. allowed component temperature rise).
5. Since in circuits used at voltages over 280 V peak-to-peak the risk for an intrinsically active flammability after a capacitor breakdown (short circuit) increases, it is recommended that the power to the component is limited to 100 times the values mentioned in the table: "Heat conductivity"
6. When using these capacitors as across-the-line capacitor in the input filter for mains applications or as series connected with an impedance to the mains the applicant must guarantee that the following conditions are fulfilled in any case (spikes and surge voltages from the mains included).

Voltage Conditions for 6 Above

ALLOWED VOLTAGES	$T_{amb} \leq 85 \text{ }^\circ\text{C}$	$85 \text{ }^\circ\text{C} < T_{amb} \leq 105 \text{ }^\circ\text{C}$
Maximum continuous RMS voltage	U_{Rac}	See "Max. AC voltage as function of temperature CBB952" per characteristics
Maximum temperature RMS-overvoltage (< 24 h)	$1.25 \times U_{Rac}$	U_{Rac}
Maximum peak voltage (V_{O-P}) (< 2 s)	$1.6 \times U_{Rdc}$	$1.3 \times U_{Rdc}$

EXAMPLE

C = 330 nF - 63 V used for the voltage signal shown in next drawing.

$U_{P-P} = 40 \text{ V}$; $U_P = 35 \text{ V}$; $T_1 = 100 \text{ } \mu\text{s}$; $T_2 = 200 \text{ } \mu\text{s}$

The ambient temperature is $35 \text{ }^\circ\text{C}$

Checking conditions:

1. The peak voltage $U_P = 35 \text{ V}$ is lower than 63 Vdc
2. The peak-to-peak voltage 40 V is lower than $2\sqrt{2} \times 40 \text{ Vac} = 113 \text{ } U_{P-P}$
3. The voltage pulse slope (dU/dt) = $40 \text{ V}/100 \text{ } \mu\text{s} = 0.4 \text{ V}/\mu\text{s}$
This is lower than $60 \text{ V}/\mu\text{s}$ (see specific reference data for each version)
4. The dissipated power is 16.2 mW as calculated with fourier terms
The temperature rise for $W_{max.} = 3.5 \text{ mm}$ and pitch = 5 mm will be $16.2 \text{ mW}/3.0 \text{ mW}/^\circ\text{C} = 5.4 \text{ }^\circ\text{C}$
This is lower than $15 \text{ }^\circ\text{C}$ temperature rise at $35 \text{ }^\circ\text{C}$, according figure max. allowed component temperature rise
5. Not applicable
6. Not applicable

Voltage Signal

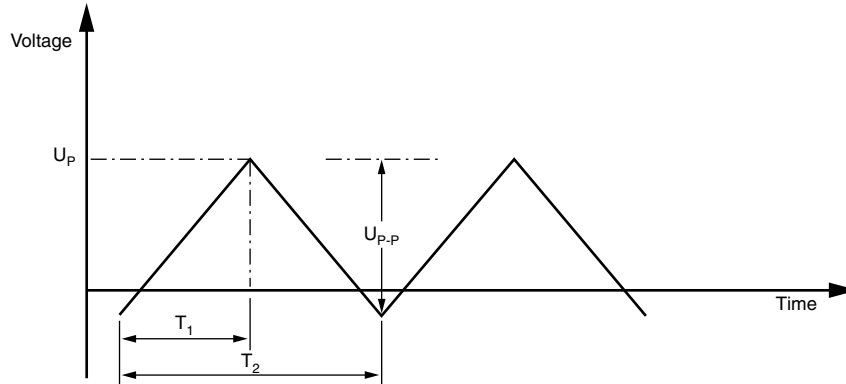

INSPECTION REQUIREMENTS

General Notes:

Sub-clause numbers of tests and performance requirements refer to the “Sectional Specification, Publication IEC 60384-2 and Specific Reference Data”.

Group C Inspection Requirements

SUB-CLAUSE NUMBER AND TEST	CONDITIONS	PERFORMANCE REQUIREMENTS
SUB-GROUP C1A PART OF SAMPLE OF SUB-GROUP C1		
4.1 Dimensions (detail)		As specified in chapters “General Data” of this specification
4.3.1 Initial measurements	Capacitance Tangent of loss angle: For $C \leq 470$ nF at 100 kHz for 470 nF < $C \leq 10$ μ F at 10 kHz for $C > 10$ μ F at 1 kHz	
4.3 Robustness of terminations	Tensile and bending	No visible damage
4.4 Resistance to soldering heat	Method: 1A Solder bath: 280 °C \pm 5 °C Duration: 10 s	
4.14 Component solvent resistance	Isopropylalcohol at room temperature Method: 2 Immersion time: 5 ± 0.5 min Recovery time: Min. 1 h, max. 2 h	
4.4.2 Final measurements	Visual examination Capacitance Tangent of loss angle	No visible damage Legible marking $ \Delta C/C \leq 2\%$ of the value measured initially Increase of $\tan \delta$ ≤ 0.005 for: $C \leq 100$ nF or ≤ 0.010 for: 100 nF < $C \leq 220$ nF or ≤ 0.015 for: 220 nF < $C \leq 470$ nF and ≤ 0.003 for: $C > 470$ nF Compared to values measured in 4.3.1



DC Film Capacitor
MKT Radial Potted Type

Vishay BCcomponents

SUB-CLAUSE NUMBER AND TEST	CONDITIONS	PERFORMANCE REQUIREMENTS
SUB-GROUP C1B PART OF SAMPLE OF SUB-GROUP C1		
4.6.1 Initial measurements	Capacitance Tangent of loss angle: For $C \leq 470$ nF at 100 kHz for 470 nF < $C \leq 10$ μ F at 10 kHz for $C > 10$ μ F at 1 kHz	No visible damage
4.6 Rapid change of temperature	$\theta A = -55$ °C $\theta B = +105$ °C 5 cycles Duration $t = 30$ min	
4.7 Vibration	Visual examination Mounting: See section "Mounting" of this specification Procedure B4 Frequency range: 10 Hz to 55 Hz Amplitude: 0.75 mm or Acceleration 98 m/s ² (whichever is less severe) Total duration 6 h	No visible damage
4.7.2 Final inspection	Visual examination	No visible damage
4.9 Shock	Mounting: See section "Mounting" of this specification Pulse shape: Half sine Acceleration: 490 m/s ² Duration of pulse: 11 ms	
4.9.3 Final measurements	Visual examination Capacitance Tangent of loss angle Insulation resistance	No visible damage $ \Delta C/C \leq 3$ % of the value measured in 4.6.1 Increase of $\tan \delta$ ≤ 0.010 (370 and 371) ≤ 0.005 (372 and 373) for: $C \leq 100$ nF or ≤ 0.010 for: 100 nF < $C \leq 220$ nF or ≤ 0.015 for: 220 nF < $C \leq 470$ nF and ≤ 0.003 for: $C > 470$ nF Compared to values measured in 4.6.1 As specified in section "Insulation Resistance" of this specification
SUB-GROUP C1 COMBINED SAMPLE OF SPECIMENS OF SUB-GROUPS C1A AND C1B		
4.10 Climatic sequence		
4.10.2 Dry heat	Temperature: + 105 °C Duration: 16 h	
4.10.3 Damp heat cyclic Test Db, first cycle		
4.10.4 Cold	Temperature: - 55 °C Duration: 2 h	
4.10.6 Damp heat cyclic Test Db, remaining cycles		
4.10.6.2 Final measurements	Voltage proof = U_{Rdc} for 1 min within 15 min after removal from testchamber Visual examination Capacitance Tangent of loss angle Insulation resistance	No breakdown of flash-over No visible damage Legible marking $ \Delta C/C \leq 3$ % of the value measured in 4.4.2 or 4.9.3 Increase of $\tan \delta$ ≤ 0.010 (370 and 371) ≤ 0.005 (372 and 373) for: $C \leq 100$ nF or ≤ 0.010 for: 100 nF < $C \leq 220$ nF or ≤ 0.015 for: 220 nF < $C \leq 470$ nF and ≤ 0.005 for: $C > 470$ nF Compared to values measured in 4.3.1 or 4.6.1 ≥ 50 % of values specified in section "Insulation Resistance" of this specification

SUB-CLAUSE NUMBER AND TEST	CONDITIONS	PERFORMANCE REQUIREMENTS
SUB-GROUP C2		
4.11 Damp heat steady state 4.11.1 Initial measurements 4.11.3 Final measurements	56 days, 40 °C, 90 % to 95 % RH Capacitance Tangent of loss angle at 1 kHz Voltage proof = U_{Rdc} for 1 min within 15 min after removal from testchamber Visual examination Capacitance Tangent of loss angle Insulation resistance	No breakdown of flash-over No visible damage Legible marking $ \Delta C/C \leq 5\%$ of the value measured in 4.11.1. Increase of $\tan \delta \leq 0.005$ Compared to values measured in 4.11.1 $\geq 50\%$ of values specified in section "Insulation Resistance" of this specification
SUB GROUP C3		
4.12 Endurance 4.12.1 Initial measurements 4.12.5 Final measurements	Duration: 2000 h 1.25 x U_{Rdc} at 85 °C 0.8 x 1.25 U_{Rdc} at 105 °C Capacitance Tangent of loss angle: For $C \leq 470$ nF at 100 kHz for 470 nF < $C \leq 10$ μ F at 10 kHz for $C > 10$ μ F at 1 kHz Visual examination Capacitance Tangent of loss angle Insulation resistance	No visible damage Legible marking $ \Delta C/C \leq 5\%$ compared to values measured in 4.12.1 Increase of $\tan \delta$ ≤ 0.005 at 85 °C (370 and 371) ≤ 0.010 at 100 °C (370 and 371) ≤ 0.005 (372 and 373) for: $C \leq 100$ nF or ≤ 0.010 for: 100 nF < $C \leq 220$ nF or ≤ 0.015 for: 220 nF < $C \leq 470$ nF and ≤ 0.003 for: $C > 470$ nF Compared to values measured in 4.12.1 $\geq 50\%$ of values specified in section "Insulation Resistance" of this specification
SUB-GROUP C4		
4.13 Charge and discharge 4.13.1 Initial measurements 4.13.3 Final measurements	10 000 cycles Charged to U_{Rdc} Discharge resistance: $R = \frac{U_R}{C \times 2.5 \times (dU/dt)_R}$ Capacitance Tangent of loss angle: For $C \leq 470$ nF at 100 kHz for 470 nF < $C \leq 10$ μ F at 10 kHz for $C > 10$ μ F at 1 kHz Capacitance Tangent of loss angle Insulation resistance	$ \Delta C/C \leq 3\%$ compared to values measured in 4.13.1 Increase of $\tan \delta$ ≤ 0.005 for: $C \leq 100$ nF or ≤ 0.010 for: 100 nF < $C \leq 220$ nF or ≤ 0.015 for: 220 nF < $C \leq 470$ nF and ≤ 0.003 for: $C > 470$ nF Compared to values measured in 4.13.1 $\geq 50\%$ of values specified in section "Insulation Resistance" of this specification



Disclaimer

All product specifications and data are subject to change without notice.

Vishay Intertechnology, Inc., its affiliates, agents, and employees, and all persons acting on its or their behalf (collectively, "Vishay"), disclaim any and all liability for any errors, inaccuracies or incompleteness contained herein or in any other disclosure relating to any product.

Vishay disclaims any and all liability arising out of the use or application of any product described herein or of any information provided herein to the maximum extent permitted by law. The product specifications do not expand or otherwise modify Vishay's terms and conditions of purchase, including but not limited to the warranty expressed therein, which apply to these products.

No license, express or implied, by estoppel or otherwise, to any intellectual property rights is granted by this document or by any conduct of Vishay.

The products shown herein are not designed for use in medical, life-saving, or life-sustaining applications unless otherwise expressly indicated. Customers using or selling Vishay products not expressly indicated for use in such applications do so entirely at their own risk and agree to fully indemnify Vishay for any damages arising or resulting from such use or sale. Please contact authorized Vishay personnel to obtain written terms and conditions regarding products designed for such applications.

Product names and markings noted herein may be trademarks of their respective owners.