

Part Number: KM2520SF4C03

Features

- SUBMINIATURE PACKAGE.
- MECHANICALLY AND SPECTRALLY MATCHED TO THE PHOTOTRANSISTOR.
- GULL WING LEAD.
- LONG LIFE - SOLID STATE RELIABILITY.
- LOW PACKAGE PROFILE.
- PACKAGE : 1000PCS / REEL.
- MOISTURE SENSITIVITY LEVEL : LEVEL 3.
- RoHS COMPLIANT.

Description

SF4 Made with Gallium Aluminum Arsenide Infrared Emitting diodes.

Package Dimensions

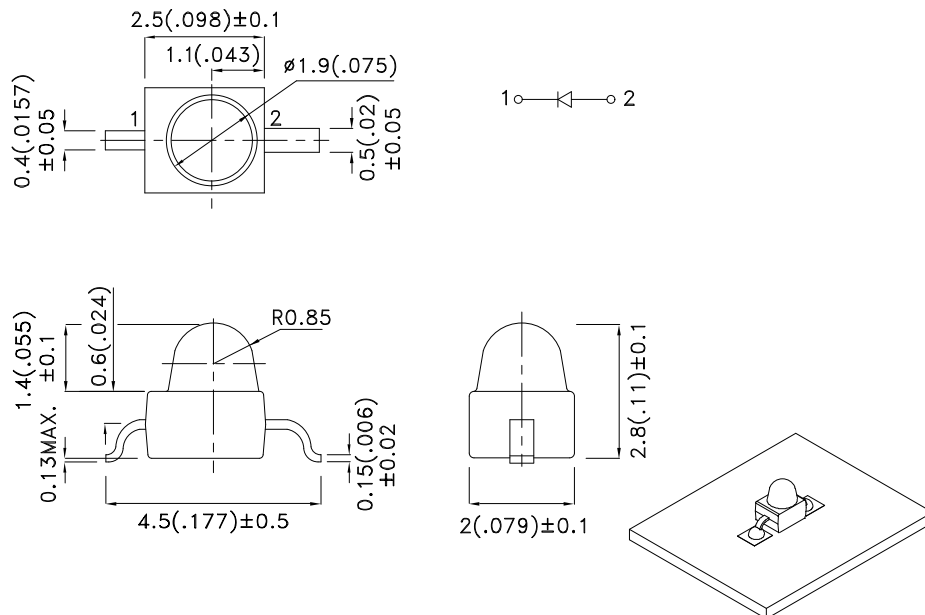

Notes:

1. All dimensions are in millimeters (inches).
2. Tolerance is $\pm 0.25(0.01)$ unless otherwise noted.
3. Lead spacing is measured where the leads emerge from the package.
4. Specifications are subject to change without notice.
5. The device has a single mounting surface. The device must be mounted according to the specifications.



Selection Guide

Part No.	Dice	Lens Type	Po (mW/sr) [2] @ 20mA *50mA		Viewing Angle [1]
			Min.	Typ.	2θ1/2
KM2520SF4C03	SF4 (GaAlAs)	WATER CLEAR	1.6	4	20°
			*2.6	*8	

Notes:

1. θ1/2 is the angle from optical centerline where the luminous intensity is 1/2 the optical centerline value.
2. * Luminous intensity with asterisk is measured at 50mA; Radiant Intensity/ luminous flux: +/-15%.

Electrical / Optical Characteristics at TA=25°C

Parameter	P/N	Symbol	Typ.	Max.	Units	Test Conditions
Forward Voltage [1]	SF4	V _F	1.3	1.6	V	I _F =20mA
Reverse Current	SF4	I _R		10	uA	V _R = 5V
Capacitance	SF4	C	90		pF	V _F =0V;f=1MHz
Peak Spectral Wavelength	SF4	λ _P	880		nm	I _F =20mA
Spectral Bandwidth	SF4	Δλ1/2	50		nm	I _F =20mA

Note:

1. Forward Voltage: +/-0.1V.

Absolute Maximum Ratings at TA=25°C

Parameter	Symbol	SF4	Units
Power dissipation	P _T	80	mW
DC Forward Current	I _F	50	mA
Peak Forward Current [1]	i _{FS}	1.2	A
Reverse Voltage	V _R	5	V
Operating Temperature	T _A	-40 To +85	°C
Storage Temperature	T _{STG}	-40 To +85	°C

Note:

1. 1/100 Duty Cycle, 10μs Pulse Width.

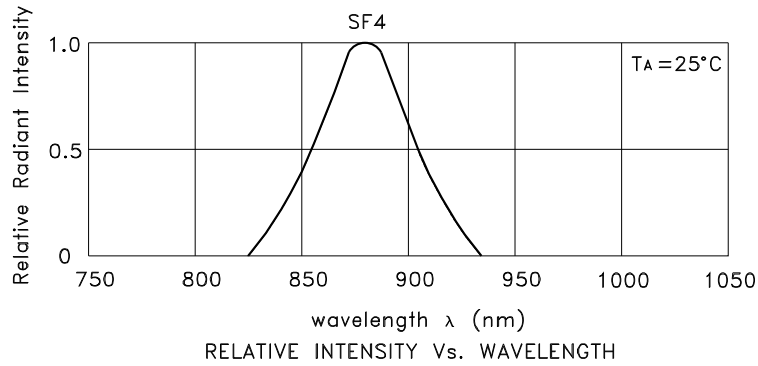

KM2520SF4C03

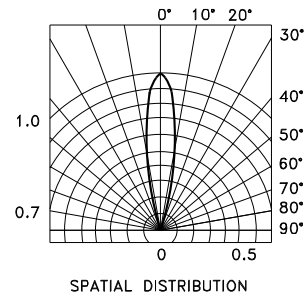
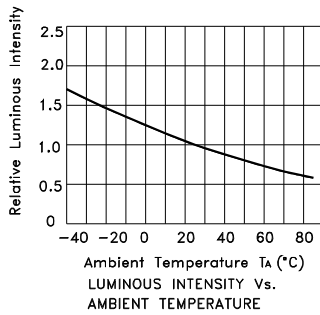
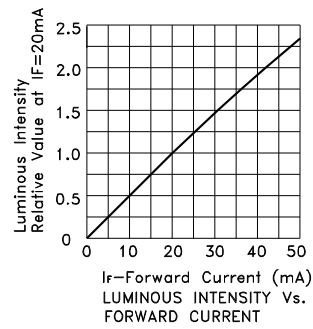
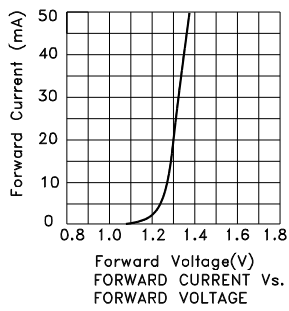

KM2520SF4C03

Reflow Soldering Profile For Lead-free SMT Process.

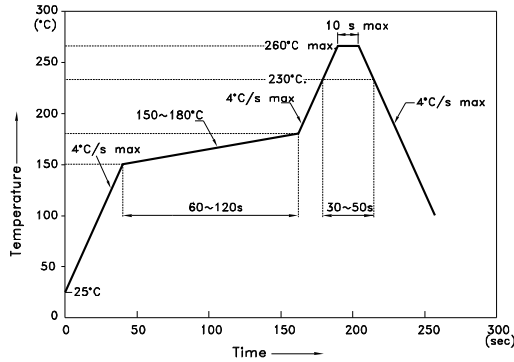

NOTES:

1. We recommend the reflow temperature 245°C(+/-5°C). The maximum soldering temperature should be limited to 260°C.
2. Don't cause stress to the epoxy resin while it is exposed to high temperature.
3. Number of reflow process shall be 2 times or less.

Recommended Soldering Pattern (Units : mm; Tolerance: ± 0.1)

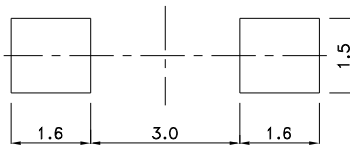

Tape Specifications (Units : mm)

