

Engwinklige LED im MIDLED-Gehäuse
Narrow beam LED in MIDLED package
Lead (Pb) Free Product - RoHS Compliant

SFH 4640
SFH 4645

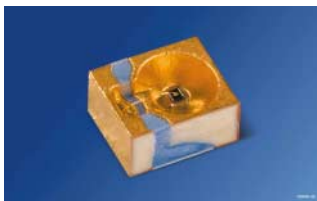

SFH 4640



SFH 4645

Wesentliche Merkmale

- Infrarot LED mit hoher Ausgangsleistung (45 mW)
- Emissionswellenlänge typ. 940 nm
- Enger Abstrahlwinkel ($\pm 15^\circ$)
- Geringe Bauhöhe
- Als Toplooker und Sidelooker einsetzbar
- SFH 4640: Gurtung als Toplooker
SFH 4645: Gurtung als Sidelooker

Anwendungen

- Infrarotbeleuchtung für Kameras
- IR-Datenübertragung
- Sensorik in der Automobiltechnik
- Fernsteuerung

Sicherheitshinweise

Je nach Betriebsart emittieren diese Bauteile hochkonzentrierte, nicht sichtbare Infrarot-Strahlung, die gefährlich für das menschliche Auge sein kann. Produkte, die diese Bauteile enthalten, müssen gemäß den Sicherheitsrichtlinien der IEC-Normen 60825-1 und 62471 behandelt werden.

Features

- High Power (45 mW) Infrared LED
- Peak wavelength typ. 940 nm
- Narrow halfangle ($\pm 15^\circ$)
- Low profile component
- Usable as top-looking and side-looking device
- SFH 4640: Taping as Toplooker
SFH 4645: Taping as Sidelooker

Applications

- Infrared Illumination for cameras
- IR Data Transmission
- Automotive sensors
- Remote controls

Safety Advices

Depending on the mode of operation, these devices emit highly concentrated non visible infrared light which can be hazardous to the human eye. Products which incorporate these devices have to follow the safety precautions given in IEC 60825-1 and IEC 62471.

Typ Type	Bestellnummer Ordering Code	Strahlstärkegruppierung ¹⁾ ($I_F = 100 \text{ mA}$, $t_p = 20 \text{ ms}$) Radiant Intensity Grouping ¹⁾ I_e (mW/sr)
SFH 4640	Q65110A9369	≥ 25 (typ. 60)
SFH 4645	Q65110A9367	≥ 25 (typ. 60)

¹⁾ gemessen bei einem Raumwinkel $\Omega = 0.01 \text{ sr}$ / measured at a solid angle of $\Omega = 0.01 \text{ sr}$

Grenzwerte ($T_A = 25\text{ °C}$)**Maximum Ratings**

Bezeichnung Parameter	Symbol Symbol	Wert Value	Einheit Unit
Betriebs- und Lagertemperatur Operating and storage temperature range	T_{op}, T_{stg}	- 40 ... + 100	°C
Sperrspannung Reverse voltage	V_R	5	V
Vorwärtsgleichstrom Forward current	I_F	100	mA
Stoßstrom, $t_p = 300\text{ }\mu\text{s}$, $D = 0$ Surge current	I_{FSM}	1	A
Verlustleistung Power dissipation	P_{tot}	180	mW
Wärmewiderstand Sperrschicht - Umgebung bei Montage auf FR4 Platine, Padgröße je 16 mm^2 Thermal resistance junction - ambient mounted on PC-board (FR4), padsize 16 mm^2 each	R_{thJA}	340	K/W
Wärmewiderstand Sperrschicht - Lötstelle bei Montage auf Metall-Block Thermal resistance junction - soldering point, mounted on metal block	R_{thJS}	180	K/W

Kennwerte ($T_A = 25\text{ °C}$)**Characteristics**

Bezeichnung Parameter	Symbol Symbol	Wert Value	Einheit Unit
Wellenlänge der Strahlung Wavelength at peak emission $I_F = 100\text{ mA}$	λ_{peak}	950	nm
Centroid-Wellenlänge der Strahlung Centroid wavelength $I_F = 100\text{ mA}$	$\lambda_{centroid}$	940	nm
Spektrale Bandbreite bei 50% von I_{max} Spectral bandwidth at 50% of I_{max} $I_F = 100\text{ mA}$	$\Delta\lambda$	42	nm
Abstrahlwinkel Half angle	φ	± 15	Grad deg.

Kennwerte ($T_A = 25\text{ °C}$)
Characteristics (cont'd)

Bezeichnung Parameter	Symbol Symbol	Wert Value	Einheit Unit
Aktive Chipfläche Active chip area	A	0.09	mm ²
Abmessungen der aktiven Chipfläche Dimension of the active chip area	$L \times B$ $L \times W$	0.3×0.3	mm ²
Schaltzeiten, I_e von 10% auf 90% und von 90% auf 10%, bei $I_F = 100\text{ mA}$, $R_L = 50\ \Omega$ Switching times, I_e from 10% to 90% and from 90% to 10%, $I_F = 100\text{ mA}$, $R_L = 50\ \Omega$	t_r , t_f	11	ns
Durchlassspannung Forward voltage $I_F = 100\text{ mA}$, $t_p = 20\text{ ms}$ $I_F = 1\text{ A}$, $t_p = 100\ \mu\text{s}$	V_F V_F	1.5 (< 1.8) 2.3 (< 3.0)	V V
Sperrstrom Reverse current	I_R	not designed for reverse operation	μA
Gesamtstrahlungsfluss Total radiant flux $I_F = 100\text{ mA}$, $t_p = 20\text{ ms}$	$\Phi_{e\text{ typ}}$	45	mW
Temperaturkoeffizient von I_e bzw. Φ_e , $I_F = 100\text{ mA}$ Temperature coefficient of I_e or Φ_e , $I_F = 100\text{ mA}$	TC_I	- 0.5	%/K
Temperaturkoeffizient von V_F , $I_F = 100\text{ mA}$ Temperature coefficient of V_F , $I_F = 100\text{ mA}$	TC_V	- 3	mV/K
Temperaturkoeffizient von λ , $I_F = 100\text{ mA}$ Temperature coefficient of λ , $I_F = 100\text{ mA}$	TC_λ	+ 0.3	nm/K

Strahlstärke I_e in Achsrichtung¹⁾

gemessen bei einem Raumwinkel $\Omega = 0.01$ sr

Radiant Intensity I_e in Axial Direction

at a solid angle of $\Omega = 0.01$ sr

Bezeichnung Parameter	Symbol	Werte Values			Einheit Unit
		-T	-U	-V	
Strahlstärke Radiant intensity $I_F = 100$ mA, $t_p = 20$ ms	$I_{e \text{ min}}$ $I_{e \text{ max}}$	25 50	40 80	63 125	mW/sr mW/sr
Strahlstärke Radiant intensity $I_F = 1$ A, $t_p = 25$ μ s	$I_{e \text{ typ}}$	260	420	660	mW/sr

¹⁾ Nur eine Gruppe in einer Verpackungseinheit (Streuung kleiner 2:1) /
Only one bin in one packing unit (variation lower 2:1)

Abstrahlcharakteristik

Radiation Characteristics $I_{rel} = f(\varphi)$

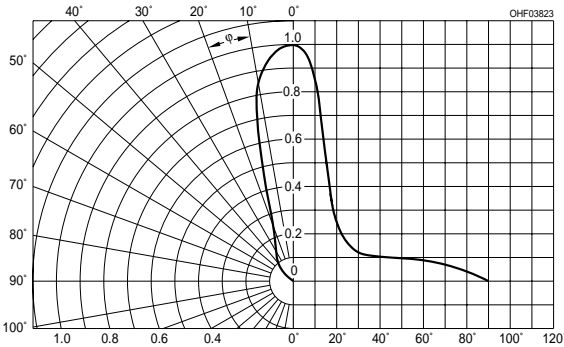

Relative Spectral Emission

$I_{rel} = f(\lambda)$

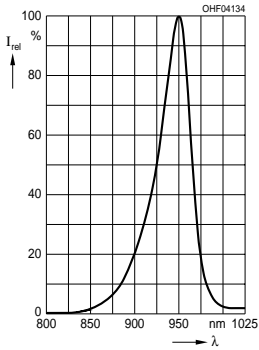

Radiant Intensity $\frac{I_e}{I_e(100 \text{ mA})} = f(I_F)$

Single pulse, $t_p = 25 \mu\text{s}$

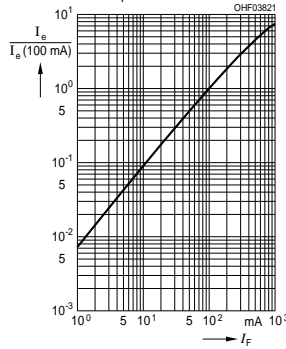

Max. Permissible Forward Current

$I_F = f(T_A), R_{thJA} = 340 \text{ K/W}$

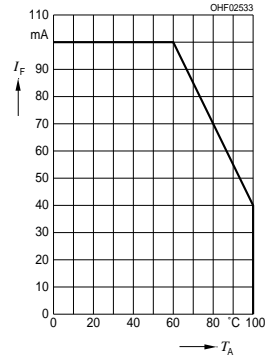

Forward Current $I_F = f(V_F)$

Single pulse, $t_p = 100 \mu\text{s}$

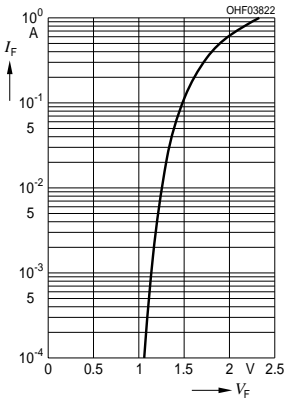

Permissible Pulse Handling Capability

$I_F = f(t)$, $T_A = 25 \text{ °C}$,
duty cycle $D = \text{parameter}$

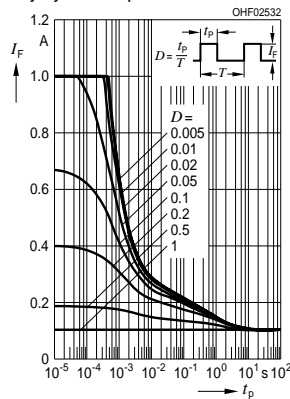

Maßzeichnung
Package Outlines

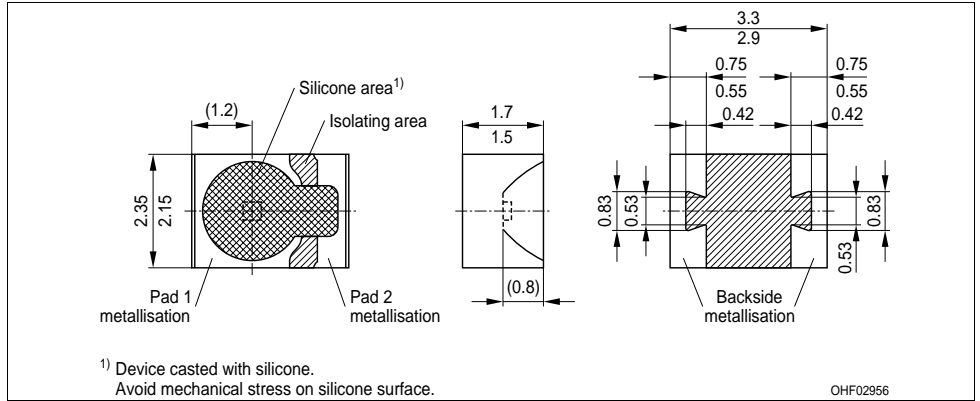

Maße in mm / Dimensions in mm.

Gehäuse / Package	MID mit klarem Silikonverguss / MID casted with clear Silicone
Anschlussbelegung Pin configuration	Pad 1 = Anode / anode Pad 2 = Kathode / cathode

Gurtung / Polarität und Lage

Verpackungseinheit 2000/Rolle, ø180 mm
oder 9000/Rolle, ø330 mm

Method of Taping / Polarity and Orientation

Packing unit 2000/reel, ø180 mm
or 9000/reel, ø330 mm

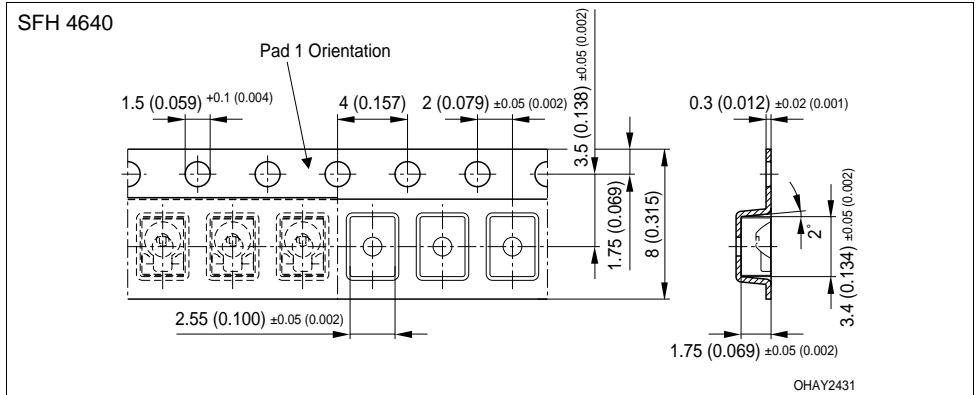

Maße in mm (inch) / Dimensions in mm (inch).

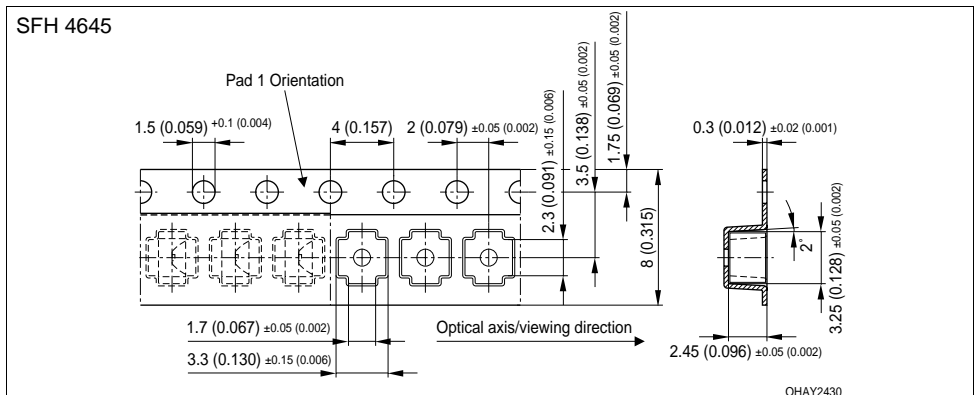

Maße in mm (inch) / Dimensions in mm (inch).

Empfohlenes Lötpaddesign Recommended Solder Pad Design

SFH 4640

Padgeometrie für
verbesserte Wärmeableitung

Paddesign for improved
heat dissipation

Cu-Fläche > 16 mm²
Cu-area

 Lötstopplack
Solder resist

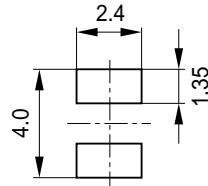
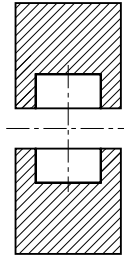

OHF02422

SFH 4645

Padgeometrie für
verbesserte Wärmeableitung

Paddesign for improved
heat dissipation

Cu-Fläche > 16 mm²
Cu-area

 Lötstopplack
Solder resist

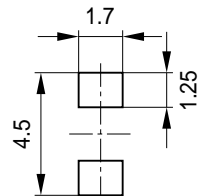
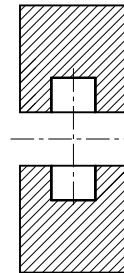

OHF02421

Maße in mm / Dimensions in mm.

Verarbeitungshinweis: Das Gehäuse ist mit Silikon vergossen. Mechanischer Stress auf der Bauteiloberfläche sollte so gering wie möglich gehalten werden.

Handling indication: The package is casted with silicone. Mechanical stress at the surface of the unit should be as low as possible.

Lötbedingungen
Soldering Conditions
Reflow Lötprofil für bleifreies Löten
Reflow Soldering Profile for lead free soldering

Vorbehandlung nach JEDEC Level 2
 Preconditioning acc. to JEDEC Level 2
 (nach J-STD-020C)
 (acc. to J-STD-020C)

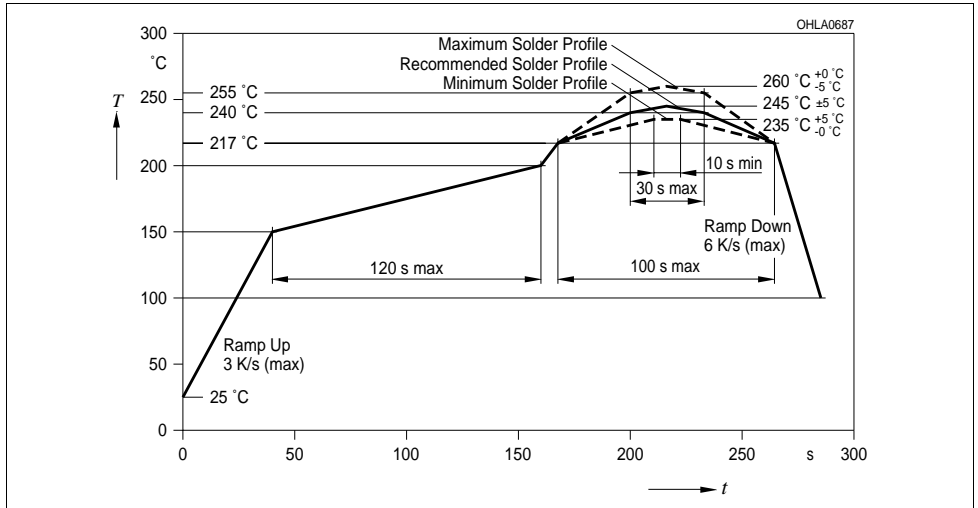

Published by
OSRAM Opto Semiconductors GmbH
 Leibnizstrasse 4, D-93055 Regensburg
www.osram-os.com
 © All Rights Reserved.

EU RoHS and China RoHS compliant product



此产品符合欧盟 RoHS 指令的要求；
 按照中国的相关法规和标准，不含有毒有害物质或元素。

The information describes the type of component and shall not be considered as assured characteristics. Terms of delivery and rights to change design reserved. Due to technical requirements components may contain dangerous substances. For information on the types in question please contact our Sales Organization.

Packing

Please use the recycling operators known to you. We can also help you – get in touch with your nearest sales office. By agreement we will take packing material back, if it is sorted. You must bear the costs of transport. For packing material that is returned to us unsorted or which we are not obliged to accept, we shall have to invoice you for any costs incurred.

Components used in life-support devices or systems must be expressly authorized for such purpose! Critical components¹, may only be used in life-support devices or systems² with the express written approval of OSRAM OS.

¹ A critical component is a component used in a life-support device or system whose failure can reasonably be expected to cause the failure of that life-support device or system, or to affect its safety or effectiveness of that device or system.

² Life support devices or systems are intended (a) to be implanted in the human body, or (b) to support and/or maintain and sustain human life. If they fail, it is reasonable to assume that the health of the user may be endangered.