

## Ceramic Capacitors (Safety Regulations) For Surface Mounting Types BC and FC

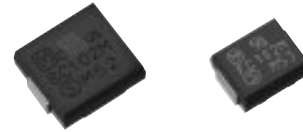

### ■ Features

- Resin molded SMD type for reflow soldering
- High reliability
- Safety requirement approved by UL, SEMKO, NEMKO, FIMKO, DEMKO and KTL (for Type FC)

### ■ Recommended Application

- Interference suppressors circuit and Isolation circuit of IT equipment such as MODEM.
- Interference suppressors circuit of small power supply machinery such as DC-DC converters and power modules.

### ■ Explanation of Part Numbers

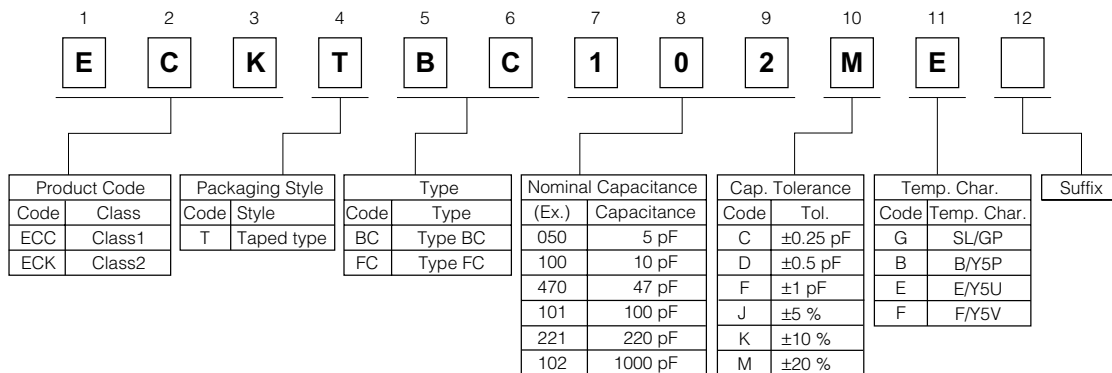

### ■ Construction

- Type BC, FC

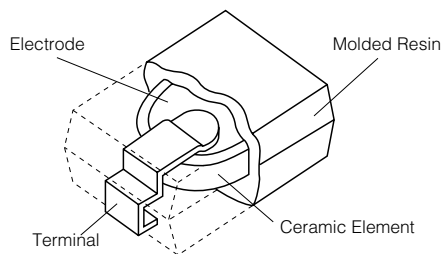

### ■ Dimensions in mm (not to scale)

- Type BC, FC

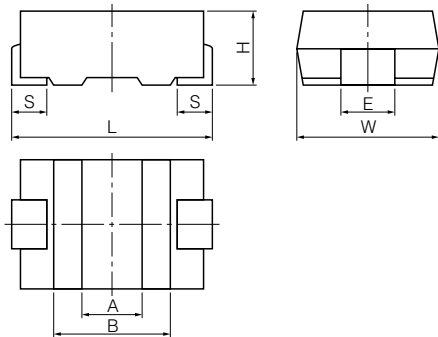

Symbol	L	W	H	S	E	A	B
Dim. Type BC	7.1±0.5	6.3±0.3	2.5±0.3	1.45±0.30	2.5±0.2	(2.0)	(3.7)
Type FC	5.7±0.5	4.5±0.3	2.3 max.	0.85±0.30	2.5±0.2	(1.7)	(3.1)

### ■ Specifications

Characteristics	Temp. Char. SL/GP	Temp. Char. B/Y5P, E/Y5U, F/Y5V										
Operating Temperature Range	-25 to 100 °C (-25 to 85 °C for UL approved)											
Rated Voltage	250 VAC											
Dielectric Withstanding Voltage	1500 VAC for 1 minute											
Capacitance	Within the specified tolerance, when measured at 1 MHz±20 %, 1 to 5 Vrms. and 20 °C	Within the specified tolerance, when measured at 1 kHz±20 %, 1 to 5 Vrms. and 20 °C										
Q or Dissipation Factor (tan δ)	30 pF or under Q ≥ 200+10 C (C:Cap.pF) over 30 pF Q ≥ 500 at 1 MHz±20 %, 1 to 5 Vrms. and 20 °C	tan δ ≤ 0.025 at 1 kHz±20 %, 1 to 5 Vrms. and 20 °C										
Insulation Resistance	10000 M Ω min. at 500 VDC and 1 minute electrification											
Temperature Characteristics	Temperature Coefficient: +350 to -1000 ppm/°C over the temperature range 20 to 85 °C	<table border="1"> <thead> <tr> <th>Char.</th> <th>Max. Cap. Change</th> <th>Temp. Range</th> </tr> </thead> <tbody> <tr> <td>B/Y5P</td> <td>±10 %</td> <td rowspan="3">-25 to 85 °C</td> </tr> <tr> <td>E/Y5U</td> <td>+20, -55 %</td> </tr> <tr> <td>F/Y5V</td> <td>+30, -80 %</td> </tr> </tbody> </table>	Char.	Max. Cap. Change	Temp. Range	B/Y5P	±10 %	-25 to 85 °C	E/Y5U	+20, -55 %	F/Y5V	+30, -80 %
Char.	Max. Cap. Change	Temp. Range										
B/Y5P	±10 %	-25 to 85 °C										
E/Y5U	+20, -55 %											
F/Y5V	+30, -80 %											

### ■ Related Standards and Certificate Number

Certification Body	Related Standard	Certificate Number		Sub-Class	Rated Voltage	Dielectric Withstanding Voltage	Operating Temperature Range
		Type BC	Type FC				
UL (USA)	UL1414*	E62674	—	—	250 VAC	1500 VAC	-25 to 85 °C
	UL1414 6th Ed.	—	E62674	Y2		2000 VAC	
	CSA C22.2 No.1*	E62674	—	—		1500 VAC	
SEMKO (Sweden)	EN132 400:1994 Sub-class Y2 (IEC 60384-14 2nd.Ed.)	0026049/01	0101074/01 0126276/01	Y2	250 VAC	1500 VAC	-25 to 100 °C
FIMKO (Finland)		—	FI 16588 FI 17348				
DEMKO (Denmark)		—	310914-01 310698-01				
NEMKO (Norway)		—	P01101830 P01100665				
KTL (Korea)		K60384-14 (IEC60384-14 2nd Ed.)	—				

Note : \* is for Line-by-pass capacitors. Certification Number sometimes changes with the change of the approval contents and so on.  
KTL mark is indicated on the label.

### ■ Ratings and Characteristics

Type Name	Part Number	Capacitance (pF)	Cap. Tolerance	Temp. Char	Dimensions in mm
Type BC	ECCTBC100DG	10	±0.5 pF	SL/GP	7.1L×6.3W×2.5H
	ECCTBC150JG	15	±5 %	SL/GP	
	ECCTBC220JG	22	±5 %	SL/GP	
	ECCTBC330JG	33	±5 %	SL/GP	
	ECCTBC470JG	47	±5 %	SL/GP	
	ECCTBC680JG	68	±5 %	SL/GP	
	ECKTBC101KB	100	±10 %	B/Y5P	
	ECKTBC151KB	150	±10 %	B/Y5P	
	ECKTBC221KB	220	±10 %	B/Y5P	
	ECKTBC331KB	330	±10 %	B/Y5P	
	ECKTBC471KB	470	±10 %	B/Y5P	
	ECKTBC681KB	680	±10 %	B/Y5P	
	ECKTBC102ME	1000	±20 %	E/Y5U	
	ECKTBC152ME	1500	±20 %	E/Y5U	
	ECKTBC222ME	2200	±20 %	E/Y5U	
	ECKTBC332MF	3300	±20 %	F/Y5V	
ECKTBC472MF	4700	±20 %	F/Y5V		
Type FC	ECCTFC100DG	10	±0.5 pF	SL/GP	5.7L×4.5W×2.3H
	ECCTFC150JG	15	±5 %	SL/GP	
	ECCTFC220JG	22	±5 %	SL/GP	
	ECCTFC330JG	33	±5 %	SL/GP	
	ECKTFC470KB	47	±10 %	B/Y5P	
	ECKTFC680KB	68	±10 %	B/Y5P	
	ECKTFC101KB	100	±10 %	B/Y5P	
	ECKTFC151KB	150	±10 %	B/Y5P	
	ECKTFC221KB	220	±10 %	B/Y5P	
	ECKTFC331KB	330	±10 %	B/Y5P	
	ECKTFC471KB	470	±10 %	B/Y5P	
	ECKTFC102ME	1000	±20 %	E/Y5U	
	ECKTFC152MF	1500	±20 %	F/Y5V	
	ECKTFC222MF	2200	±20 %	F/Y5V	

Notes \* Other capacitance values are available by special order.

- Packaging Methods (Taping)
- Minimum Quantity/Packing Unit

Type	Packaging style	Part Number		Minimum Packing Quantity	Packing Quantity in Carton	Carton Dimensions in mm (LxWxH)
Type BC	Embossed Carrier Taping	EC□TBC□□□□□□	10 to 2200 pF	2000 pcs./reel	6000 pcs.	350×350×62
Type FC	Embossed Carrier Taping	EC□TFC□□□□□□	10 to 2200 pF	3000 pcs./reel	9000 pcs.	350×350×62

- Reel

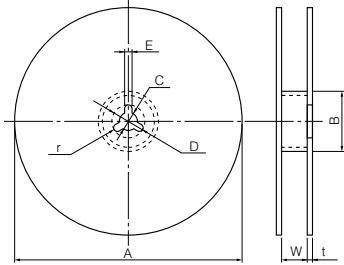

Unit:(mm)								
Symbol	A	B	C	D	E	W	t	r
Dim. (mm)	330±5	60 min.	13.0±0.5	21.0±1.0	2.0±0.5	13.5±1.5	2.0±0.5	R1.0

- Embossed carrier taping

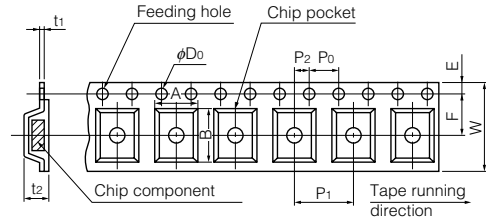

Unit:(mm)												
Symbol	A	B	W	F	E	P1	P2	P0	φD0	t1	t2	
Dim. (mm)	Type BC	6.5 ±0.2	7.5 ±0.2	12.0 ±0.3	5.5 ±0.1	1.75 ±0.10	8.0 ±0.1	2.00 ±0.05	4.0 ±0.1	1.5 +0.1 -0	0.3 ±0.1	3.2 ±0.3
	Type FC	4.8 ±0.2	6.0 ±0.2									2.8 ±0.3

- Leader Part and Taped End

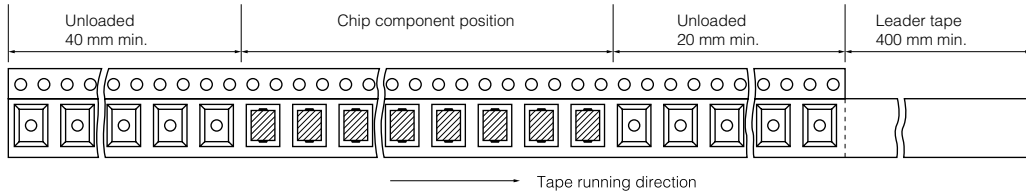

### ■ Typical Characteristics

- Temperature Characteristics

Char. SL/GP (Temp.Coeff.:+350 to -1000 ppm/°C)

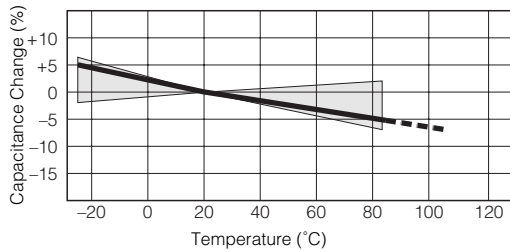

Char. B/Y5P (Temp.Range:-25 to 85 °C Max.Cap.Change:±10 %)

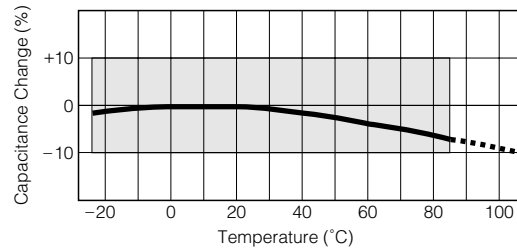

Char. E/Y5U (Temp.Range:-25 to 85 °C max.Cap.Change:+20, -55 %)

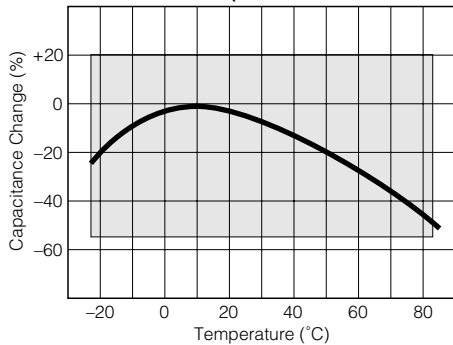

Char. F/Y5V (Temp.Range:-25 to 85 °C max.Cap.Change:+30, -80 %)

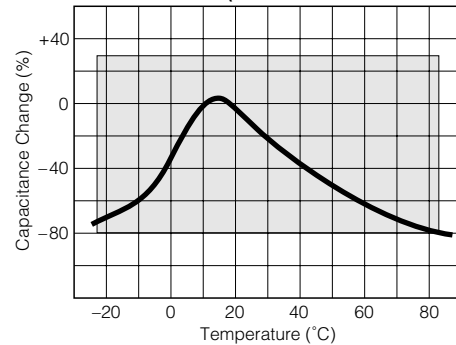

Design and specifications are each subject to change without notice. Ask factory for the current technical specifications before purchase and/or use. Should a safety concern arise regarding this product, please be sure to contact us immediately.

### Typical Characteristics

#### Impedance vs. Frequency Characteristics

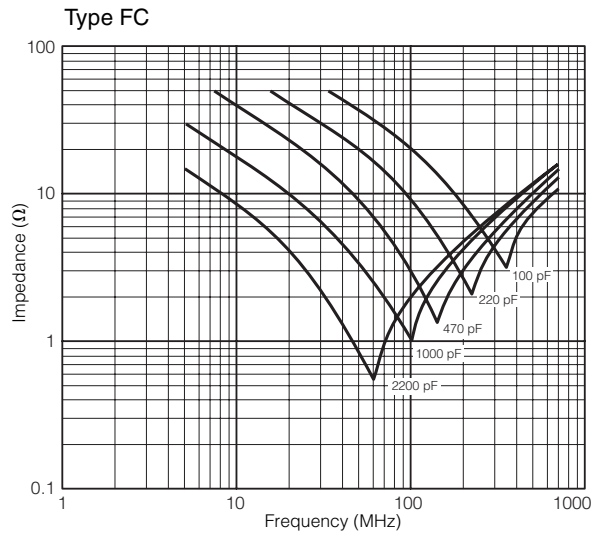
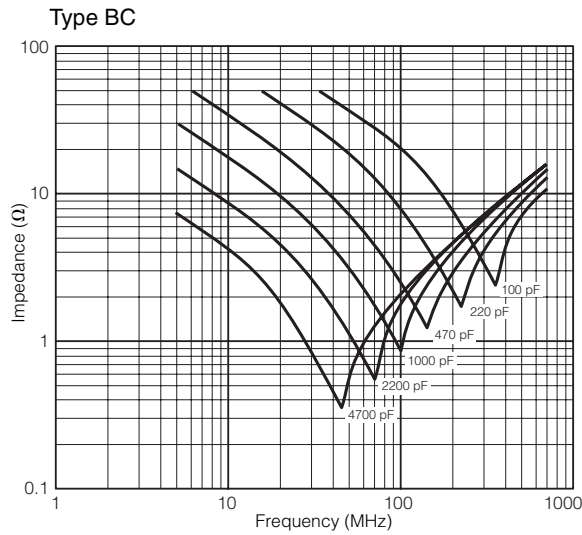

#### Current vs. Voltage (Leakage Current Characteristics)

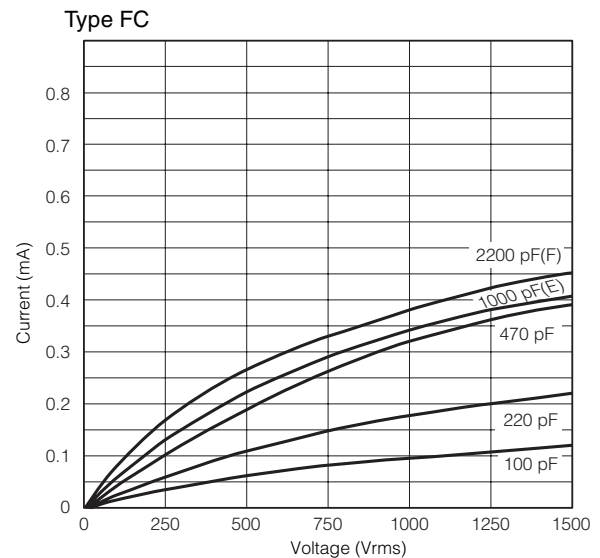
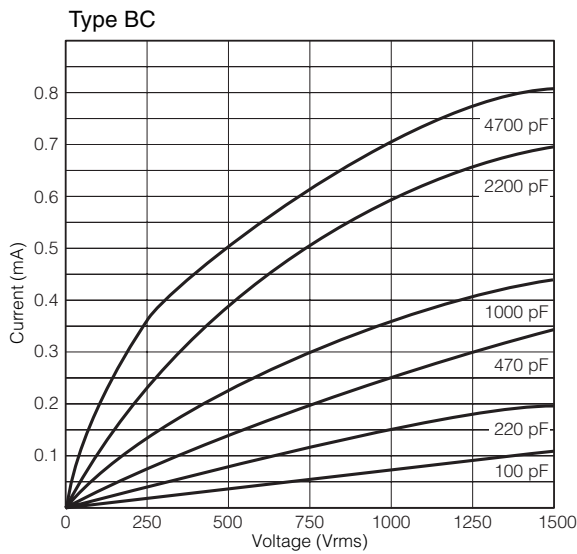

### Application Examples

#### MODEM

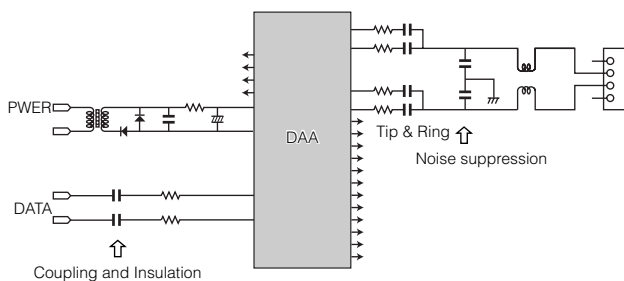

#### Primary circuit of Switching Power Supply

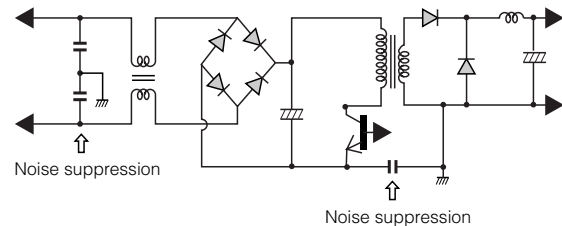

Design and specifications are each subject to change without notice. Ask factory for the current technical specifications before purchase and/or use. Should a safety concern arise regarding this product, please be sure to contact us immediately.