

Y5V Dielectric

General Specifications

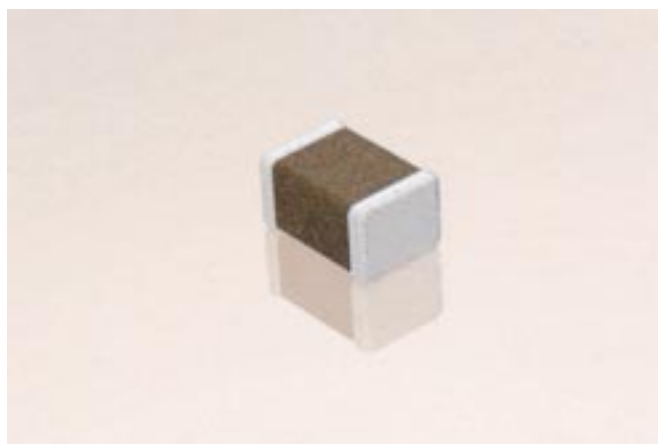

Y5V formulations are for general-purpose use in a limited temperature range. They have a wide temperature characteristic of +22% –82% capacitance change over the operating temperature range of –30°C to +85°C.

Y5V's high dielectric constant allows the manufacture of the highest capacitance value in a given case size.

These characteristics make Y5V ideal for decoupling applications within limited temperature range.

PART NUMBER (see page 3 for complete part number explanation)

0805

Size
(L" x W")

3

Voltage
10V = Z
16V = Y
25V = 3
50V = 5

G

Dielectric
Y5V = G

104

Capacitance Code

Z

Capacitance Tolerance
Z = +80 –20%

A

Failure Rate
A = Not Applicable

T

Terminations
T = Plated Ni and Solder

2

Packaging
2 = 7" Reel
4 = 13" Reel

A

Special Code
A = Std. Product

PERFORMANCE CHARACTERISTICS

| | |
|--|---|
| Capacitance Range | 2200 pF to 22 μ F |
| Capacitance Tolerances | +80 –20% |
| Operating Temperature Range | –30°C to +85°C |
| Temperature Characteristic | +22% to –82% max. within operating temperature |
| Voltage Ratings | 10, 16, 25 and 50 VDC (+85°C) |
| Dissipation Factor | For 50 volts: 5.0% max. For 16 and 25 volts: 7% max. For 10 volts: 10% max. |
| Insulation Resistance (+25°C, RVDC) | 10,000 megohms min. or 1000 M Ω - μ F min., whichever is less |
| Dielectric Strength | 250% of rated voltage for 5 seconds at 50 mamp max. current |
| Test Voltage | 1.0 Vrms \pm 0.2 Vrms |
| Test Frequency | 1 KHz |

Typical Characteristic Curves**

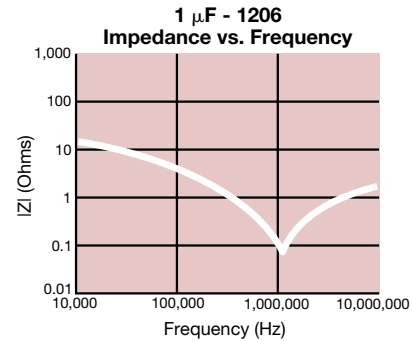
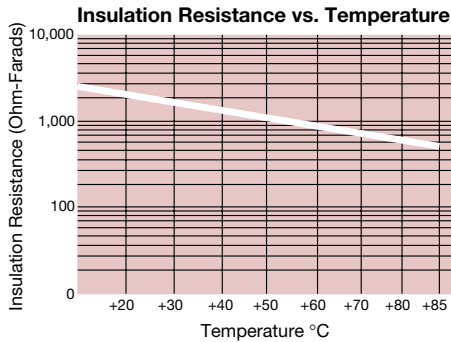
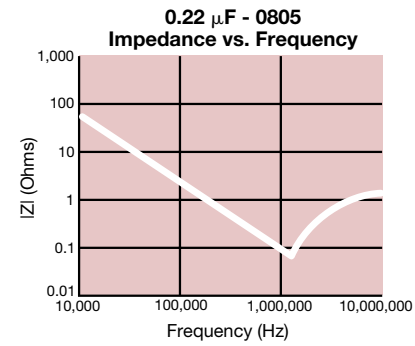
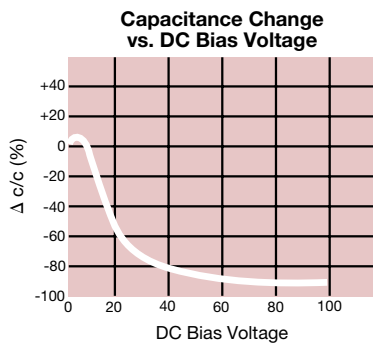
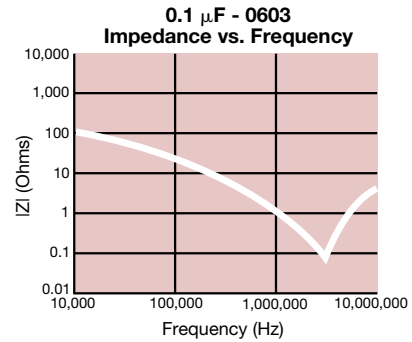
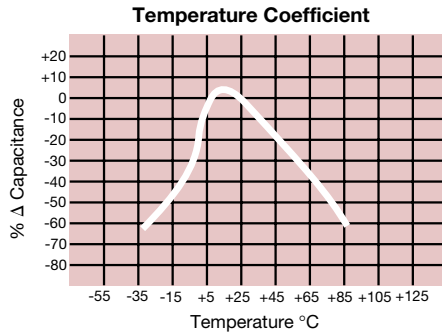

SUMMARY OF CAPACITANCE RANGES VS. CHIP SIZE

| Style | 10V | 16V | 25V | 50V |
|--------------|---------------|----------------|----------------|----------------|
| 0402* | 2.2nF - 0.1μF | 2.2nF - 0.1μF | 2.2nF - 22nF | 2.2nF - 10nF |
| 0603* | 2.2nF - 1μF | 2.2nF - 0.33μF | 2.2nF - 0.22μF | 2.2nF - 56nF |
| 0805* | 10nF - 4.7μF | 10nF - 2.2μF | 10nF - 1μF | 10nF - 0.33μF |
| 1206* | 10nF - 10μF | 10nF - 4.7μF | 10nF - 2.2μF | 10nF - 1μF |
| 1210* | 10nF - 22μF | 0.1μF - 10μF | 0.1μF - 4.7μF | 0.1μF - 1μF |
| 1812* | → | → | 0.15μF - 1.5μF | 1.5nF - 1.5μF |
| 1825* | → | → | 0.47μF - 1.5μF | 0.47μF - 1.5μF |
| 2220 | — | — | — | 1μF - 1.5μF |
| 2225 | → | → | 0.68μF - 2.2μF | 0.68μF - 1.5μF |

* Standard Sizes

** For additional information on performance changes with operating conditions consult AVX's software SpiCap.

Y5V Dielectric

Capacitance Range



PREFERRED SIZES ARE SHADED

| SIZE | 0402* | | 0603* | | 0805 | | 1206 | | 1210 | | 1812* | | 1825* | | 2220* | | 2225* | |
|--------------------|----------------------|-----------------------------|-----------------------------|-----------------------------|-----------------------------|-----------------------------|-----------------------------|-----------------------------|----------------------------|-----------------------------|-----------------------------|-----------------------------|-----------------------------|-----------------------------|-----------------------------|-----------------------------|-----------------------------|-----------------------------|
| | All Paper | | All Paper | | Paper/Embossed | | Paper/Embossed | | Paper/Embossed | | All Embossed | | All Embossed | | All Embossed | | All Embossed | |
| (L) Length | MM (in.) | 1.00 ± .10 (.040 ± .004) | 1.60 ± .15 (.063 ± .006) | 2.01 ± .20 (.079 ± .008) | 3.20 ± .20 (.126 ± .008) | 3.20 ± .20 (.126 ± .008) | 4.50 ± .30 (.177 ± .012) | 4.50 ± .30 (.177 ± .012) | 5.7 ± 0.4 (.225 ± .016) | 5.7 ± 0.4 (.225 ± .016) | 5.72 ± .25 (.225 ± .010) | 5.72 ± .25 (.225 ± .010) | 5.72 ± .25 (.225 ± .010) | 5.72 ± .25 (.225 ± .010) | 5.72 ± .25 (.225 ± .010) | 5.72 ± .25 (.225 ± .010) | 5.72 ± .25 (.225 ± .010) | 5.72 ± .25 (.225 ± .010) |
| (W) Width | MM (in.) | .50 ± .10 (.020 ± .004) | .81 ± .15 (.032 ± .006) | 1.25 ± .20 (.049 ± .008) | 1.60 ± .20 (.063 ± .008) | 2.50 ± .20 (.098 ± .008) | 3.20 ± .20 (.126 ± .008) | 6.40 ± .40 (.252 ± .016) | 5.0 ± 0.4 (.197 ± .016) | 6.35 ± .25 (.250 ± .010) | 6.35 ± .25 (.250 ± .010) | 6.35 ± .25 (.250 ± .010) | 6.35 ± .25 (.250 ± .010) | 6.35 ± .25 (.250 ± .010) | 6.35 ± .25 (.250 ± .010) | 6.35 ± .25 (.250 ± .010) | 6.35 ± .25 (.250 ± .010) | 6.35 ± .25 (.250 ± .010) |
| (T) Max. Thickness | MM (in.) | .60 (.024) | .90 (.035) | 1.30 (.051) | 1.50 (.059) | 1.70 (.067) | 1.70 (.067) | 2.30 (.090) | 2.30 (.090) | 2.30 (.090) | 2.30 (.090) | 2.30 (.090) | 2.30 (.090) | 2.30 (.090) | 2.30 (.090) | 2.30 (.090) | 2.30 (.090) | 2.30 (.090) |
| (t) Terminal | MM (in.) | .25 ± .15 (.010 ± .006) | .35 ± .15 (.014 ± .006) | .50 ± .25 (.020 ± .010) | .50 ± .25 (.020 ± .010) | .50 ± .25 (.020 ± .010) | .61 ± .36 (.024 ± .014) | .61 ± .36 (.024 ± .014) | .64 ± .39 (.025 ± .015) | .64 ± .39 (.025 ± .015) | .64 ± .39 (.025 ± .015) | .64 ± .39 (.025 ± .015) | .64 ± .39 (.025 ± .015) | .64 ± .39 (.025 ± .015) | .64 ± .39 (.025 ± .015) | .64 ± .39 (.025 ± .015) | .64 ± .39 (.025 ± .015) | .64 ± .39 (.025 ± .015) |
| WVDC | | 10 16 25 50 | 10 16 25 50 | 10 16 25 50 | 10 16 25 50 | 10 16 25 50 | 25 50 | 25 50 | 25 50 | 25 50 | 25 50 | 25 50 | 25 50 | 25 50 | 25 50 | 25 50 | 25 50 | 25 50 |
| Cap (pF) | 2200 2700 3300 | | | | | | | | | | | | | | | | | |
| | 3900 4700 5600 | | | | | | | | | | | | | | | | | |
| | 6800 8200 | | | | | | | | | | | | | | | | | |
| Cap (µF) | .01 .012 .015 | | | | | | | | | | | | | | | | | |
| | .018 .022 .027 | | | | | | | | | | | | | | | | | |
| | .033 .039 .047 | | | | | | | | | | | | | | | | | |
| | .056 .068 .082 | | | | | | | | | | | | | | | | | |
| | .10 .12 .15 | | | | | | | | | | | | | | | | | |
| | .18 .22 .27 | | | | | | | | | | | | | | | | | |
| | .33 .39 .47 | | | | | | | | | | | | | | | | | |
| | .56 .68 .82 | | | | | | | | | | | | | | | | | |
| | 1.0 1.2 1.5 | | | | | | | | | | | | | | | | | |
| | 1.8 2.2 2.7 | | | | | | | | | | | | | | | | | |
| | 3.3 3.9 4.7 | | | | | | | | | | | | | | | | | |
| | 5.6 6.8 8.2 | | | | | | | | | | | | | | | | | |
| | 10.0 12.0 15.0 | | | | | | | | | | | | | | | | | |
| | 18.0 22.0 | | | | | | | | | | | | | | | | | |

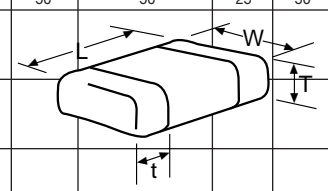

*Reflow soldering only.

NOTES: For low profile product, see page 19.

= Paper Tape
 = Embossed Tape



I. Capacitance (farads)

English: $C = \frac{.224 \text{ K A}}{T_D}$

Metric: $C = \frac{.0884 \text{ K A}}{T_D}$

II. Energy stored in capacitors (Joules, watt - sec)

$$E = \frac{1}{2} CV^2$$

III. Linear charge of a capacitor (Amperes)

$$I = C \frac{dV}{dt}$$

IV. Total Impedance of a capacitor (ohms)

$$Z = \sqrt{R_s^2 + (X_C - X_L)^2}$$

V. Capacitive Reactance (ohms)

$$X_C = \frac{1}{2 \pi fC}$$

VI. Inductive Reactance (ohms)

$$X_L = 2 \pi fL$$

VII. Phase Angles:

Ideal Capacitors: Current leads voltage 90°

Ideal Inductors: Current lags voltage 90°

Ideal Resistors: Current in phase with voltage

VIII. Dissipation Factor (%)

$$\text{D.F.} = \tan \delta \text{ (loss angle)} = \frac{\text{E.S.R.}}{X_C} = (2 \pi fC) (\text{E.S.R.})$$

IX. Power Factor (%)

P.F. = Sine δ (loss angle) = Cos ϕ (phase angle)

P.F. = (when less than 10%) = DF

X. Quality Factor (dimensionless)

$$Q = \text{Cotan } \delta \text{ (loss angle)} = \frac{1}{\text{D.F.}}$$

XI. Equivalent Series Resistance (ohms)

$$\text{E.S.R.} = (\text{D.F.}) (X_C) = (\text{D.F.}) / (2 \pi fC)$$

XII. Power Loss (watts)

$$\text{Power Loss} = (2 \pi fCV^2) (\text{D.F.})$$

XIII. KVA (Kilowatts)

$$\text{KVA} = 2 \pi fCV^2 \times 10^{-3}$$

XIV. Temperature Characteristic (ppm/°C)

$$\text{T.C.} = \frac{C_t - C_{25}}{C_{25} (T_t - 25)} \times 10^6$$

XV. Cap Drift (%)

$$\text{C.D.} = \frac{C_1 - C_2}{C_1} \times 100$$

XVI. Reliability of Ceramic Capacitors

$$\frac{L_o}{L_t} = \left(\frac{V_t}{V_o} \right)^X \left(\frac{T_t}{T_o} \right)^Y$$

XVII. Capacitors in Series (current the same)

$$\text{Any Number: } \frac{1}{C_T} = \frac{1}{C_1} + \frac{1}{C_2} \dots \frac{1}{C_N}$$

$$\text{Two: } C_T = \frac{C_1 C_2}{C_1 + C_2}$$

XVIII. Capacitors in Parallel (voltage the same)

$$C_T = C_1 + C_2 \dots + C_N$$

XIX. Aging Rate

A.R. = % Δ C/decade of time

XX. Decibels

$$\text{db} = 20 \log \frac{V_1}{V_2}$$

METRIC PREFIXES

SYMBOLS

| | | | | | | | |
|-------|---------------------|----------------|------------------------|----------------|--|----------------|-------------------------|
| Pico | X 10 ⁻¹² | K | = Dielectric Constant | f | = frequency | L _t | = Test life |
| Nano | X 10 ⁻⁹ | A | = Area | L | = Inductance | V _t | = Test voltage |
| Micro | X 10 ⁻⁶ | T _D | = Dielectric thickness | δ | = Loss angle | V _o | = Operating voltage |
| Milli | X 10 ⁻³ | V | = Voltage | ϕ | = Phase angle | T _t | = Test temperature |
| Deci | X 10 ⁻¹ | t | = time | X & Y | = exponent effect of voltage and temp. | T _o | = Operating temperature |
| Deca | X 10 ⁺¹ | R _s | = Series Resistance | L _o | = Operating life | | |
| Deca | X 10 ⁺¹ | | | | | | |
| Kilo | X 10 ⁺³ | | | | | | |
| Mega | X 10 ⁺⁶ | | | | | | |
| Giga | X 10 ⁺⁹ | | | | | | |
| Tera | X 10 ⁺¹² | | | | | | |

How to Order

Part Number Explanation

EXAMPLE: 08055A101JAT2A

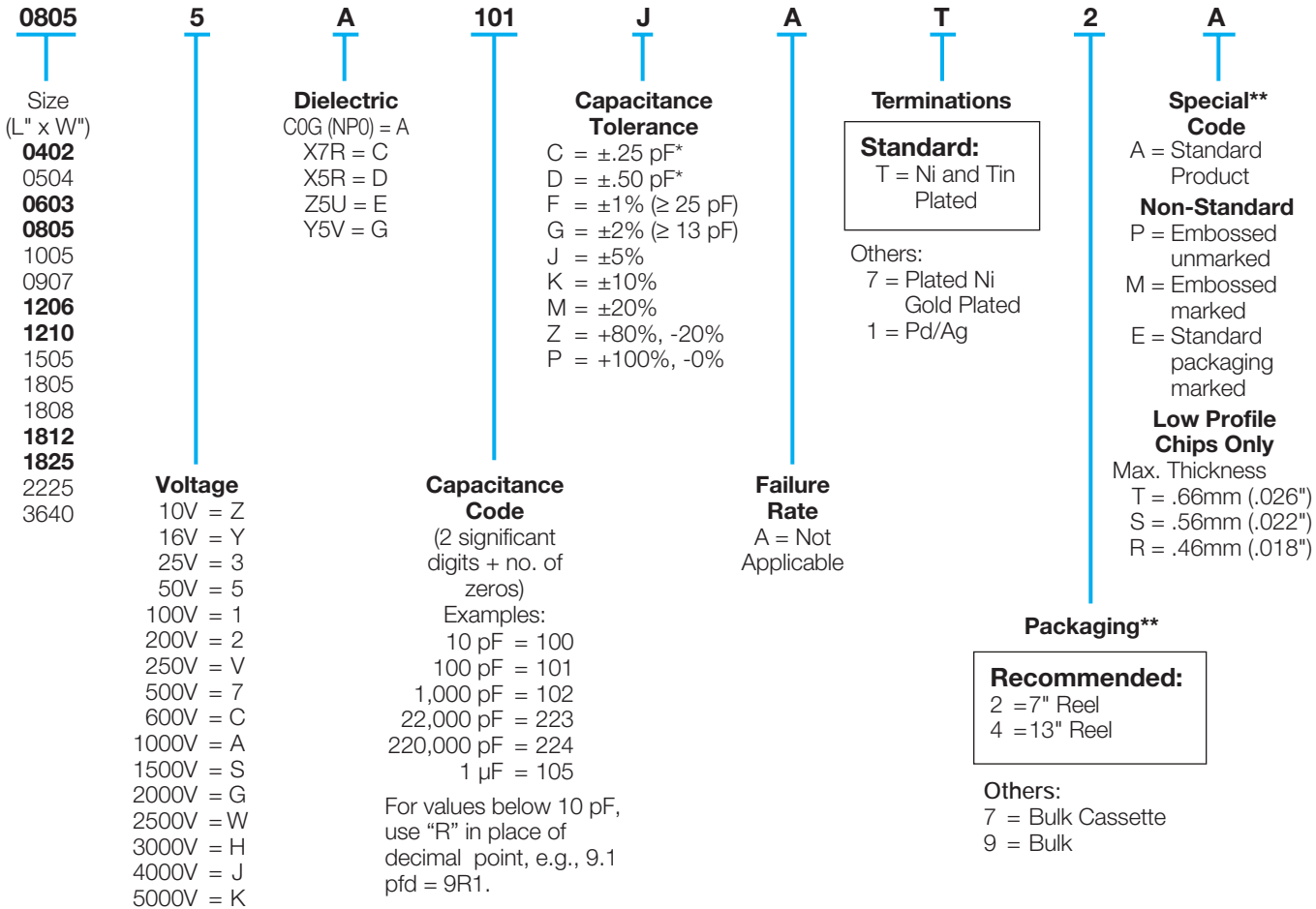

* C&D tolerances for ≤ 10 pF values.

** Standard Tape and Reel material depends upon chip size and thickness. See individual part tables for tape material type for each capacitance value.

Note: Unmarked product is standard. Marked product is available on special request, please contact AVX. Standard packaging is shown in the individual tables.

Non-standard packaging is available on special request, please contact AVX.

Environmental

THERMAL SHOCK

Specification

Appearance

No visual defects

Capacitance Variation

COG (NP0): $\pm 2.5\%$ or $\pm .25\text{pF}$, whichever is greater
 X7R: $\leq \pm 7.5\%$
 Z5U: $\leq \pm 20\%$
 Y5V: $\leq \pm 20\%$

Q, Tan Delta

To meet initial requirement

Insulation Resistance

COG (NP0), X7R: To meet initial requirement
 Z5U, Y5V: $\geq \text{Initial Value} \times 0.1$

Dielectric Strength

No problem observed

Measuring Conditions

| Step | Temperature °C | Time (minutes) |
|------|--|----------------|
| 1 | COG (NP0), X7R: $-55^\circ \pm 2^\circ$ | 30 \pm 3 |
| | Z5U: $+10^\circ \pm 2^\circ$ | |
| | Y5V: $-30^\circ \pm 2^\circ$ | |
| 2 | Room Temperature | # 3 |
| 3 | COG (NP0), X7R: $+125^\circ \pm 2^\circ$ | 30 \pm 3 |
| | Z5U, Y5V: $+85^\circ \pm 2^\circ$ | |
| 4 | Room Temperature | # 3 |

Repeat for 5 cycles and measure after 48 hours \pm 4 hours (24 hours for COG (NP0)) at room temperature.

IMMERSION

Specification

Appearance

No visual defects

Capacitance Variation

COG (NP0): $\pm 2.5\%$ or $\pm .25\text{pF}$, whichever is greater
 X7R: $\leq \pm 7.5\%$
 Z5U: $\leq \pm 20\%$
 Y5V: $\leq \pm 20\%$

Q, Tan Delta

To meet initial requirement

Insulation Resistance

COG (NP0), X7R: To meet initial requirement
 Z5U, Y5V: $\geq \text{Initial Value} \times 0.1$

Dielectric Strength

No problem observed

Measuring Conditions

| Step | Temperature °C | Time (minutes) |
|------|----------------|----------------|
| 1 | +65 \pm 5/-0 | 15 \pm 2 |
| | Pure Water | |
| 2 | 0 \pm 3 | 15 \pm 2 |
| | NaCl solution | |

Repeat cycle 2 times and wash with water and dry.
 Store at room temperature for 48 \pm 4 hours (24 hours for COG (NP0)) and measure.

MOISTURE RESISTANCE

Specification

Appearance

No visual defects

Capacitance Variation

COG (NP0): $\pm 5\%$ or $\pm .5\text{pF}$, whichever is greater
 X7R: $\leq \pm 10\%$
 Z5U: $\leq \pm 30\%$
 Y5V: $\leq \pm 30\%$

Q, Tan Delta

COG (NP0): $\geq 30\text{pF}$ Q ≥ 350
 $\geq 10\text{pF}$, $< 30\text{pF}$ Q $\geq 275+5C/2$
 $< 10\text{pF}$ Q $\geq 200+10C$
 X7R: Initial requirement + .5%
 Z5U: Initial requirement + 1%
 Y5V: Initial requirement + 2%

Insulation Resistance

$\geq \text{Initial Value} \times 0.3$

Measuring Conditions

| Step | Temp. °C | Humidity % | Time (hrs) |
|------|------------------------|--------------|------------|
| 1 | +25- \rightarrow +65 | 90-98 | 2.5 |
| 2 | +65 | 90-98 | 3.0 |
| 3 | +65- \rightarrow +25 | 80-98 | 2.5 |
| 4 | +25- \rightarrow +65 | 90-98 | 2.5 |
| 5 | +65 | 90-98 | 3.0 |
| 6 | +65- \rightarrow +25 | 80-98 | 2.5 |
| 7 | +25 | 90-98 | 2.0 |
| 7a | -10 | uncontrolled | - |
| 7b | +25 | 90-98 | - |

Repeat 20 cycles (1-7) and store for 48 hours (24 hours for COG (NP0)) at room temperature before measuring.
 Steps 7a & 7b are done on any 5 out of first 9 cycles.

Environmental

STEADY STATE HUMIDITY

(No Load)

Specification

Appearance

No visual defects

Capacitance Variation

C0G (NP0): $\pm 5\%$ or $\pm .5\text{pF}$, whichever is greater
X7R: $\leq \pm 10\%$
Z5U: $\leq \pm 30\%$
Y5V: $\leq \pm 30\%$

Q, Tan Delta

C0G (NP0): $\geq 30\text{pF}$ Q ≥ 350
 $\geq 10\text{pF}$, $< 30\text{pF}$ Q $\geq 275+5C/2$
 $< 10\text{pF}$ Q $\geq 200+10C$
X7R: Initial requirement + .5%
Z5U: Initial requirement + 1%
Y5V: Initial requirement + 2%

Insulation Resistance

\geq Initial Value x 0.3

Measuring Conditions

Store at $85 \pm 5\%$ relative humidity and 85°C for 1000 hours, without voltage. Remove from test chamber and stabilize at room temperature and humidity for 48 ± 4 hours (24 ± 2 hours for C0G (NP0)) before measuring.

Charge and discharge currents must be less than 50ma.

LOAD HUMIDITY

Specification

Appearance

No visual defects

Capacitance Variation

C0G (NP0): $\pm 5\%$ or $\pm .5\text{pF}$, whichever is greater
X7R: $\leq \pm 10\%$
Z5U: $\leq \pm 30\%$
Y5V: $\leq \pm 30\%$

Q, Tan Delta

C0G (NP0): $\geq 30\text{pF}$ Q ≥ 350
 $\geq 10\text{pF}$, $< 30\text{pF}$ Q $\geq 275+5C/2$
 $< 10\text{pF}$ Q $\geq 200+10C$
X7R: Initial requirement + .5%
Z5U: Initial requirement + 1%
Y5V: Initial requirement + 2%

Insulation Resistance

C0G (NP0), X7R: To meet initial value x 0.3
Z5U, Y5V: \geq Initial Value x 0.1

Charge devices with rated voltage in test chamber set at $85 \pm 5\%$ relative humidity and 85°C for 1000 (+48,-0) hours. Remove from test chamber and stabilize at room temperature and humidity for 48 ± 4 hours (24 ± 2 hours for C0G (NP0)) before measuring.

Charge and discharge currents must be less than 50ma.

LOAD LIFE

Specification

Appearance

No visual defects

Capacitance Variation

C0G (NP0): $\pm 3\%$ or $\pm .3\text{pF}$, whichever is greater
X7R: $\leq \pm 10\%$
Z5U: $\leq \pm 30\%$
Y5V: $\leq \pm 30\%$

Q, Tan Delta

C0G (NP0): $\geq 30\text{pF}$ Q ≥ 350
 $\geq 10\text{pF}$, $< 30\text{pF}$ Q $\geq 275+5C/2$
 $< 10\text{pF}$ Q $\geq 200+10C$
X7R: Initial requirement + .5%
Z5U: Initial requirement + 1%
Y5V: Initial requirement + 2%

Insulation Resistance

C0G (NP0), X7R: To meet initial value x 0.3
Z5U, Y5V: \geq Initial Value x 0.1

Charge devices with twice rated voltage in test chamber set at $+125^\circ\text{C} \pm 2^\circ\text{C}$ for C0G (NP0) and X7R, $+85^\circ \pm 2^\circ\text{C}$ for Z5U, and Y5V for 1000 (+48,-0) hours. Remove from test chamber and stabilize at room temperature for 48 ± 4 hours (24 ± 2 hours for C0G (NP0)) before measuring.

Charge and discharge currents must be less than 50ma.

Mechanical

END TERMINATION ADHERENCE

Specification

No evidence of peeling of end terminal

Measuring Conditions

After soldering devices to circuit board apply 5N (0.51kg f) for 10 ± 1 seconds, please refer to Figure 1.

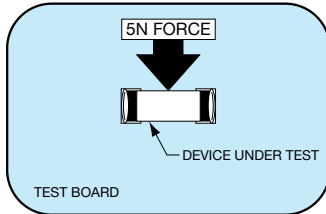

Figure 1.
Terminal Adhesion

RESISTANCE TO VIBRATION

Specification

Appearance:

No visual defects

Capacitance

Within specified tolerance

Q, Tan Delta

To meet initial requirement

Insulation Resistance

COG (NP0), X7R \geq Initial Value x 0.3
Z5U, Y5V \geq Initial Value x 0.1

Measuring Conditions

Vibration Frequency

10-2000 Hz

Maximum Acceleration

20G

Swing Width

1.5mm

Test Time

X, Y, Z axis for 2 hours each, total 6 hours of test

SOLDERABILITY

Specification

$\geq 95\%$ of each termination end should be covered with fresh solder

Measuring Conditions

Dip device in eutectic solder at $230 \pm 5^\circ\text{C}$ for $2 \pm .5$ seconds

BEND STRENGTH

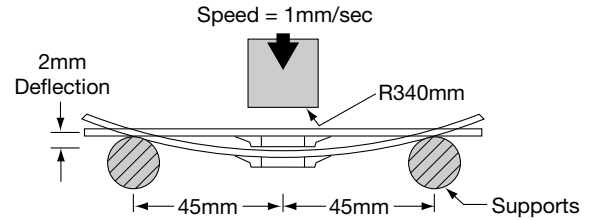

Figure 2. Bend Strength

Specification

Appearance:

No visual defects

Capacitance Variation

COG (NP0): $\pm 5\%$ or $\pm .5\text{pF}$, whichever is larger

X7R: $\leq \pm 12\%$

Z5U: $\leq \pm 30\%$

Y5V: $\leq \pm 30\%$

Insulation Resistance

COG (NP0): \geq Initial Value x 0.3

X7R: \geq Initial Value x 0.3

Z5U: \geq Initial Value x 0.1

Y5V: \geq Initial Value x 0.1

Measuring Conditions

Please refer to Figure 2

Deflection:

2mm

Test Time:

30 seconds

RESISTANCE TO SOLDER HEAT

Specification

Appearance:

No serious defects, $<25\%$ leaching of either end terminal

Capacitance Variation

COG (NP0): $\pm 2.5\%$ or $\pm 2.5\text{pF}$, whichever is greater

X7R: $\leq \pm 7.5\%$

Z5U: $\leq \pm 20\%$

Y5V: $\leq \pm 20\%$

Q, Tan Delta

To meet initial requirement

Insulation Resistance

To meet initial requirement

Dielectric Strength

No problem observed

Measuring Conditions

Dip device in eutectic solder at 260°C , for 1 minute. Store at room temperature for 48 hours (24 hours for COG (NP0)) before measuring electrical parameters.

Part sizes larger than $3.20\text{mm} \times 2.49\text{mm}$ are reheated at 150°C for 30 ± 5 seconds before performing test.

European Detail Specifications CECC 32 101-801/Chips



Standard European Ceramic Chip Capacitors

PART NUMBER (example)

0805



Size
(L" x W")

5



Voltage
50V = 5
100V = 1
200V = 2

C



Dielectric
1B CG = A
2R1 = C
2F4 = G

103



Capacitance Code

M



Capacitance Tolerance
See Dielectrics
COG, X7R, Y5V

T



Specification
CECC32101-801

T



Terminations
T = Plated Ni
and Sn

2



Marking Packaging
2 = 7" Reel
4 = 13" Reel

A



Special Code
A = Std.
Product

RANGE OF APPROVED COMPONENTS

| Case Size | Dielectric Type | Voltage and Capacitance Range | | |
|-------------|-----------------|-------------------------------|----------------|----------------|
| | | 50V | 100V | 200V |
| 1BCG | | | | |
| 0603 | 1B CG | 0.47pF - 150pF | 0.47pF - 120pF | 0.47pF - 100pF |
| 0805 | 1B CG | 0.47pF - 560pF | 0.47pF - 560pF | 0.47pF - 330pF |
| 1206 | 1B CG | 0.47pF - 3.3nF | 0.47pF - 3.3nF | 0.47pF - 1.5nF |
| 1210 | 1B CG | 0.47pF - 4.7nF | 0.47pF - 4.7nF | 0.47pF - 2.7nF |
| 1808 | 1B CG | 0.47pF - 6.8nF | 0.47pF - 6.8nF | 0.47pF - 4.7nF |
| 1812 | 1B CG | 0.47pF - 15nF | 0.47pF - 15nF | 0.47pF - 10nF |
| 2220 | 1B CG | 0.47pF - 39nF | 0.47pF - 39nF | 0.47pF - 15nF |
| 2R1 | | | | |
| 0603 | 2R1 | 10pF - 6.8nF | 10pF - 6.8nF | 10pF - 1.2nF |
| 0805 | 2R1 | 10pF - 33nF | 10pF - 18nF | 10pF - 3.3nF |
| 1206 | 2R1 | 10pF - 100nF | 10pF - 68nF | 10pF - 18nF |
| 1210 | 2R1 | 10pF - 150nF | 10pF - 100nF | 10pF - 27nF |
| 1808 | 2R1 | 10pF - 270nF | 10pF - 180nF | 10pF - 47nF |
| 1812 | 2R1 | 10pF - 470nF | 10pF - 330nF | 10pF - 100nF |
| 2220 | 2R1 | 10pF - 1.2μF | 10pF - 680nF | 10pF - 220nF |
| 2F4 | | | | |
| 0805 | 2F4 | 10pF - 100nF | | |
| 1206 | 2F4 | 10pF - 330nF | | |
| 1210 | 2F4 | 10pF - 470nF | | |
| 1808 | 2F4 | 10pF - 560nF | | |
| 1812 | 2F4 | 10pF - 1.8μF | | |
| 2220 | 2F4 | 10pF - 2.2μF | | |



Automatic Insertion Packaging

TAPE & REEL QUANTITIES

All tape and reel specifications are in compliance with RS481.

| | 8mm | 12mm | |
|---------------------------|-------------------------------|------------------|------------------------|
| Paper or Embossed Carrier | 0805, 1005, 1206, 1210 | | |
| Embossed Only | 0504, 0907 | 1505, 1805, 1808 | 1812, 1825, 2220, 2225 |
| Paper Only | 0402, 0603 | | |
| Qty. per Reel/7" Reel | 2,000 or 4,000 ⁽¹⁾ | 3,000 | 1,000 |
| Qty. per Reel/13" Reel | 10,000 | 10,000 | 4,000 |

⁽¹⁾ Dependent on chip thickness. Low profile chips shown on page 27 are 5,000 per reel for 7" reel. 0402 size chips are 10,000 per 7" reels and are not available on 13" reels. For 3640 size chip contact factory for quantity per reel.

REEL DIMENSIONS

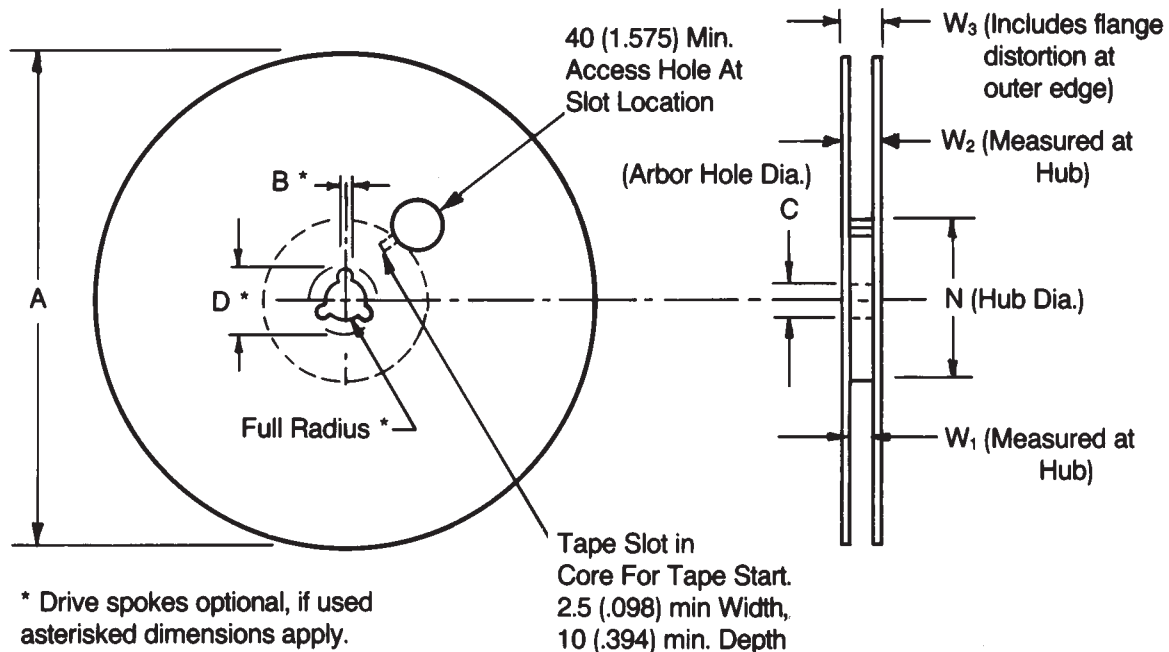

| Tape Size ⁽¹⁾ | A Max. | B* Min. | C | D* Min. | N Min. | W ₁ | W ₂ Max. | W ₃ |
|--------------------------|-----------------|---------------|--------------------------|----------------|---------------|--|---------------------|---------------------|
| 8mm | 330 (12.992) | 1.5 (.059) | 13.0±0.20 (.512±.008) | 20.2 (.795) | 50 (1.969) | 8.4 ^{+1.0} _{-0.0} (.331 ^{+0.60} _{-0.0}) | 14.4 (.567) | 7.9 Min. (.311) |
| 12mm | | | | | | 12.4 ^{+2.0} _{-0.0} (.488 ^{+0.76} _{-0.0}) | | 11.9 Min. (.469) |

Metric dimensions will govern.

English measurements rounded and for reference only.

⁽¹⁾ For tape sizes 16mm and 24mm (used with chip size 3640) consult EIA RS-481 latest revision.

Embossed Carrier Configuration



8 & 12mm Tape Only

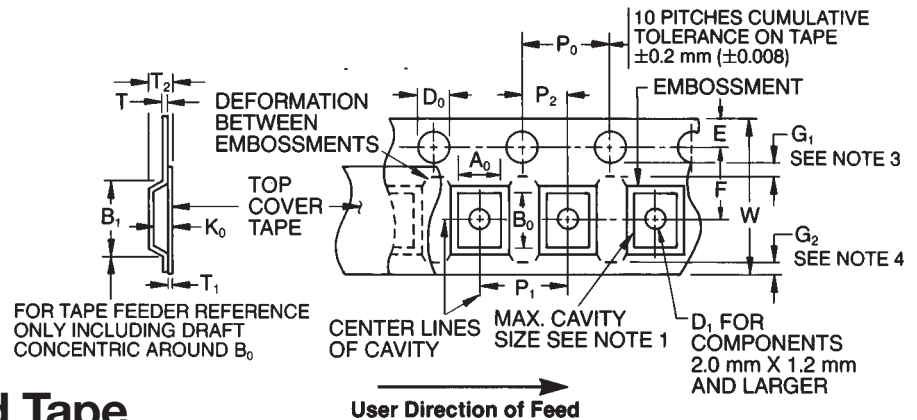

8 & 12mm Embossed Tape Metric Dimensions Will Govern

CONSTANT DIMENSIONS

| Tape Size | D ₀ | E | P ₀ | P ₂ | T Max. | T ₁ | G ₁ | G ₂ |
|--------------|---|------------------------------|-----------------------------|-----------------------------|-----------------|------------------------|--------------------------------------|--------------------------------------|
| 8mm and 12mm | 8.4 ^{+0.10} _{-0.0} (.059 ^{+0.004} _{-0.0}) | 1.75 ± 0.10 (.069 ± .004) | 4.0 ± 0.10 (.157 ± .004) | 2.0 ± 0.05 (.079 ± .002) | 0.600 (.024) | 0.10 (.004) Max. | 0.75 (.030) Min. See Note 3 | 0.75 (.030) Min. See Note 4 |

VARIABLE DIMENSIONS

| Tape Size | B ₁ Max. See Note 6 | D ₁ Min. See Note 5 | F | P ₁ | R Min. See Note 2 | T ₂ | W | A ₀ B ₀ K ₀ |
|----------------------|-----------------------------------|-----------------------------------|-----------------------------|-----------------------------|----------------------|--------------------|--|--|
| 8mm | 4.55 (.179) | 1.0 (.039) | 3.5 ± 0.05 (.138 ± .002) | 4.0 ± 0.10 (.157 ± .004) | 25 (.984) | 2.5 Max. (.098) | 8.0 ^{+0.3} _{-0.1} (.315 ^{+0.012} _{-0.004}) | See Note 1 |
| 12mm | 8.2 (.323) | 1.5 (.059) | 5.5 ± 0.05 (.217 ± .002) | 4.0 ± 0.10 (.157 ± .004) | 30 (1.181) | 6.5 Max. (.256) | 12.0 ± .30 (.472 ± .012) | See Note 1 |
| 8mm 1/2 Pitch | 4.55 (.179) | 1.0 (.039) | 3.5 ± 0.05 (.138 ± .002) | 2.0 ± 0.10 0.79 ± .004 | 25 (.984) | 2.5 Max. (.098) | 8.0 ^{+0.3} _{-0.1} (.315 ^{+0.012} _{-0.004}) | See Note 1 |
| 12mm Double Pitch | 8.2 (.323) | 1.5 (.059) | 5.5 ± 0.05 (.217 ± .002) | 8.0 ± 0.10 (.315 ± .004) | 30 (1.181) | 6.5 Max. (.256) | 12.0 ± .30 (.472 ± .012) | See Note 1 |

NOTES:

- A₀, B₀, and K₀ are determined by the max. dimensions to the ends of the terminals extending from the component body and/or the body dimensions of the component. The clearance between the end of the terminals or body of the component to the sides and depth of the cavity (A₀, B₀, and K₀) must be within 0.05 mm (.002) min. and 0.50 mm (.020) max. The clearance allowed must also prevent rotation of the component within the cavity of not more than 20 degrees (see sketches C & D).
- Tape with components shall pass around radius "R" without damage. The minimum trailer length (Note 2 Fig. 3) may require additional length to provide R min. for 12 mm embossed tape for reels with hub diameters approaching N min. (Table 4).
- G₁ dimension is the flat area from the edge of the sprocket hole to either the outward deformation of the carrier tape between the embossed cavities or to the edge of the cavity whichever is less.
- G₂ dimension is the flat area from the edge of the carrier tape opposite the sprocket holes to either the outward deformation of the carrier tape between the embossed cavity or to the edge of the cavity whichever is less.
- The embossment hole location shall be measured from the sprocket hole controlling the location of the embossment. Dimensions of embossment location and hole location shall be applied independent of each other.
- B₁ dimension is a reference dimension for tape feeder clearance only.

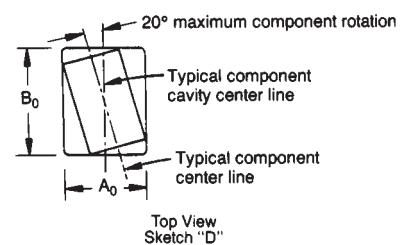
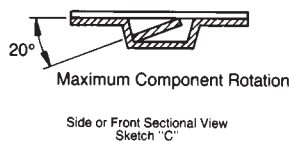

Paper Carrier Configuration



8 & 12mm Tape Only

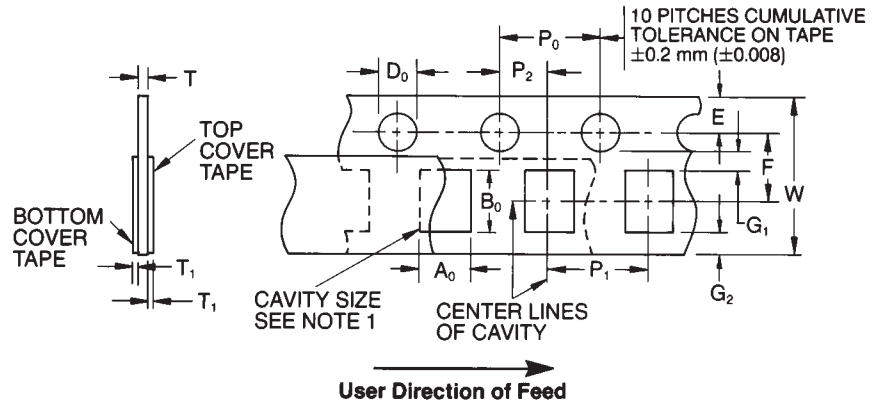

8 & 12mm Paper Tape Metric Dimensions Will Govern

CONSTANT DIMENSIONS

| Tape Size | D ₀ | E | P ₀ | P ₂ | T ₁ | G ₁ | G ₂ | R MIN. |
|--------------|---|------------------------------|-----------------------------|-----------------------------|------------------------|------------------------|------------------------|-------------------------|
| 8mm and 12mm | 1.5 ^{+0.1} _{-0.0} (.059 ^{+0.004} _{-.000}) | 1.75 ± 0.10 (.069 ± .004) | 4.0 ± 0.10 (.157 ± .004) | 2.0 ± 0.05 (.079 ± .002) | 0.10 (.004) Max. | 0.75 (.030) Min. | 0.75 (.030) Min. | 25 (.984) See Note 2 |

VARIABLE DIMENSIONS

| Tape Size | P ₁ | F | W | A ₀ B ₀ | T |
|----------------------|-----------------------------|-----------------------------|---|-------------------------------|------------|
| 8mm | 4.0 ± 0.10 (.157 ± .004) | 3.5 ± 0.05 (.138 ± .002) | 8.0 ^{+0.3} _{-0.1} (.315 ^{+0.012} _{-.004}) | See Note 1 | See Note 3 |
| 12mm | 4.0 ± .010 (.157 ± .004) | 5.5 ± 0.05 (.217 ± .002) | 12.0 ± 0.3 (.472 ± .012) | | |
| 8mm 1/2 Pitch | 2.0 ± 0.10 (.079 ± .004) | 3.5 ± 0.05 (.138 ± .002) | 8.0 ^{+0.3} _{-0.1} (.315 ^{+0.012} _{-.004}) | | |
| 12mm Double Pitch | 8.0 ± 0.10 (.315 ± .004) | 5.5 ± 0.05 (.217 ± .002) | 12.0 ± 0.3 (.472 ± .012) | | |

NOTES:

- A₀, B₀, and T are determined by the max. dimensions to the ends of the terminals extending from the component body and/or the body dimensions of the component. The clearance between the ends of the terminals or body of the component to the sides and depth of the cavity (A₀, B₀, and T) must be within 0.05 mm (.002) min. and 0.50 mm (.020) max. The clearance allowed must also prevent rotation of the component within the cavity of not more than 20 degrees (see sketches A & B).
- Tape with components shall pass around radius "R" without damage.
- 1.1 mm (.043) Base Tape and 1.6 mm (.063) Max. for Non-Paper Base Compositions.

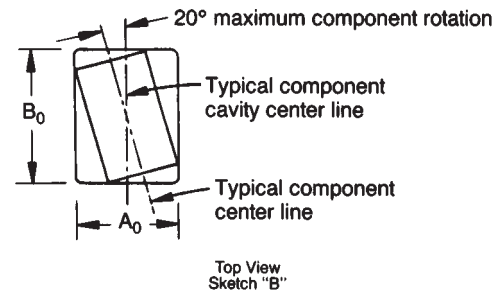
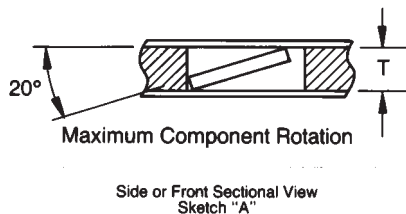

Bar Code Labeling Standard

AVX bar code labeling is available and follows latest version of EIA-556-A.



BENEFITS

- Easier handling
- Smaller packaging volume
(1/20 of T/R packaging)
- Easier inventory control
- Flexibility
- Recyclable

CASE DIMENSIONS

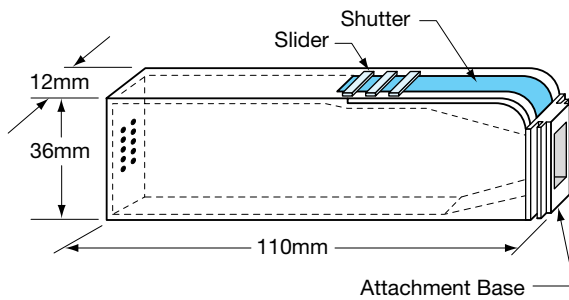

BULK FEEDER

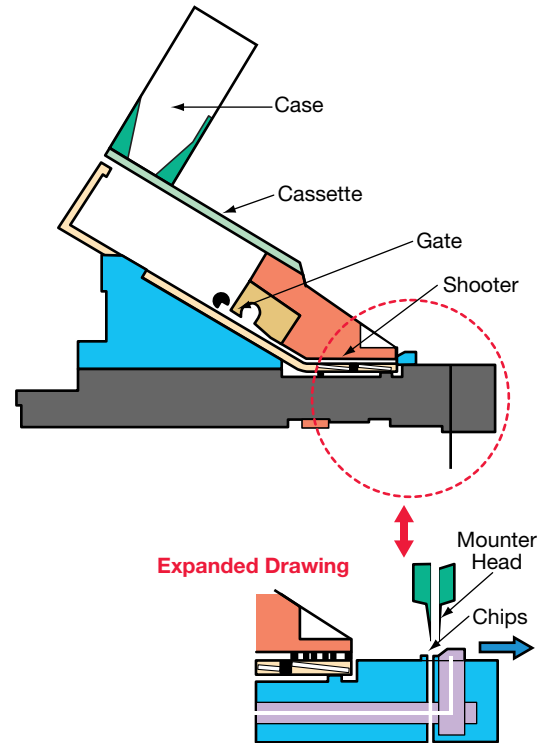

CASE QUANTITIES

| Part Size | 0402 | 0603 | 0805 |
|--------------------------|--------|--------|-------------------------------------|
| Qty. (pcs / cassette) | 80,000 | 15,000 | 10,000 (T=0.6mm) 5,000 (T≥0.6mm) |

Basic Construction – A multilayer ceramic (MLC) capacitor is a monolithic block of ceramic containing two sets of offset, interleaved planar electrodes that extend to two opposite surfaces of the ceramic dielectric. This simple

structure requires a considerable amount of sophistication, both in material and manufacture, to produce it in the quality and quantities needed in today's electronic equipment.

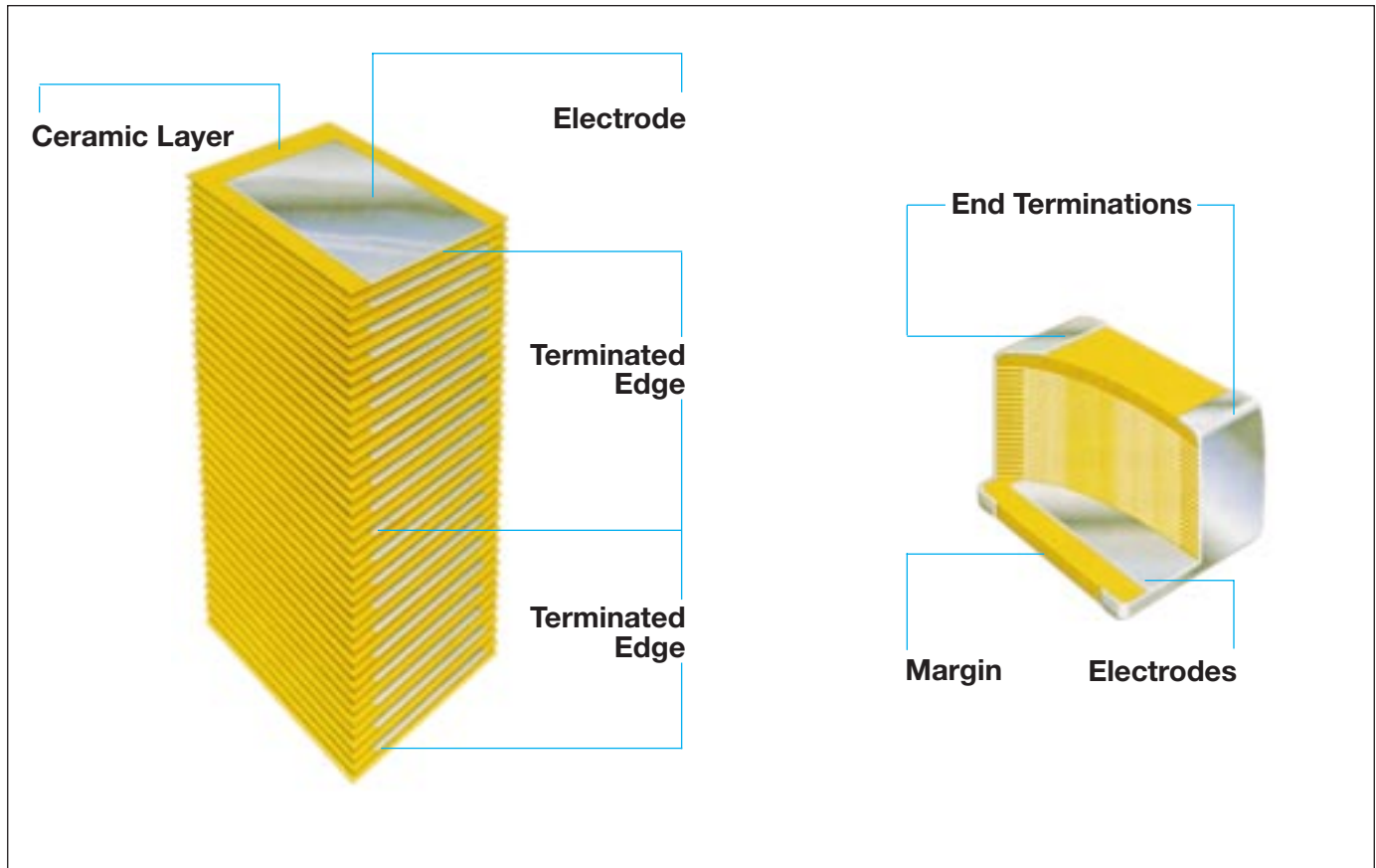

Formulations – Multilayer ceramic capacitors are available in both Class 1 and Class 2 formulations. Temperature compensating formulations are Class 1 and temperature stable and general application formulations are classified as Class 2.

Class 1 – Class 1 capacitors or temperature compensating capacitors are usually made from mixtures of titanates where barium titanate is normally not a major part of the mix. They have predictable temperature coefficients and in general, do not have an aging characteristic. Thus they are the most stable capacitor available. The most popular Class 1 multilayer ceramic capacitors are C0G (NP0) temperature compensating capacitors (negative-positive 0 ppm/°C).

Class 2 – EIA Class 2 capacitors typically are based on the chemistry of barium titanate and provide a wide range of capacitance values and temperature stability. The most commonly used Class 2 dielectrics are X7R and Y5V. The X7R provides intermediate capacitance values which vary only $\pm 15\%$ over the temperature range of -55°C to 125°C . It finds applications where stability over a wide temperature range is required.

The Y5V provides the highest capacitance values and is used in applications where limited temperature changes are expected. The capacitance value for Y5V can vary from 22% to -82% over the -30°C to 85°C temperature range. The Z5U dielectric is between X7R and Y5V in both stability and capacitance range.

All Class 2 capacitors vary in capacitance value under the influence of temperature, operating voltage (both AC and DC), and frequency. For additional information on performance changes with operating conditions, consult AVX's software, SpiCap.

Effects of Voltage – Variations in voltage have little effect on Class 1 dielectric but does affect the capacitance and dissipation factor of Class 2 dielectrics. The application of DC voltage reduces both the capacitance and dissipation factor while the application of an AC voltage within a reasonable range tends to increase both capacitance and dissipation factor readings. If a high enough AC voltage is applied, eventually it will reduce capacitance just as a DC voltage will. Figure 2 shows the effects of AC voltage.

**Cap. Change vs. A.C. Volts
AVX X7R T.C.**

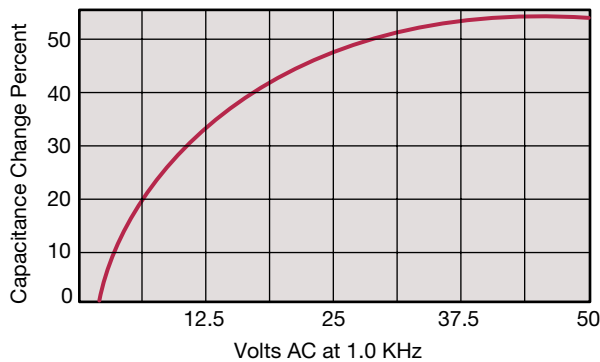

Figure 2

Capacitor specifications specify the AC voltage at which to measure (normally 0.5 or 1 VAC) and application of the wrong voltage can cause spurious readings. Figure 3 gives the voltage coefficient of dissipation factor for various AC voltages at 1 kilohertz. Applications of different frequencies will affect the percentage changes versus voltages.

**D.F. vs. A.C. Measurement Volts
AVX X7R T.C.**

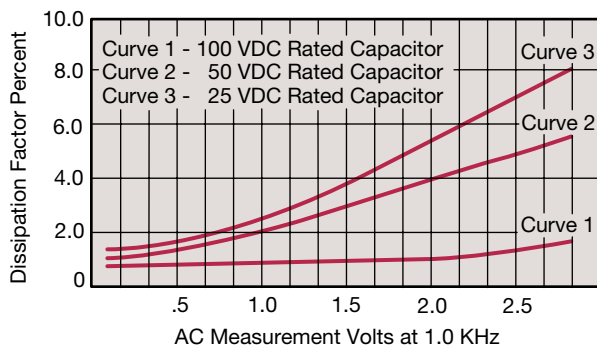

Figure 3

The effect of the application of DC voltage is shown in Figure 4. The voltage coefficient is more pronounced for higher K dielectrics. These figures are shown for room temperature conditions. The combination characteristic known as voltage temperature limits which shows the effects of rated voltage over the operating temperature range is shown in Figure 5 for the military BX characteristic.

**Cap. Change vs. D.C. Volts
AVX X7R T.C.**

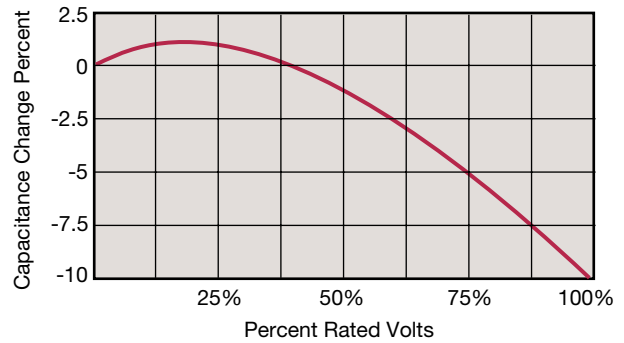

Figure 4

**Typical Cap. Change vs. Temperature
AVX X7R T.C.**

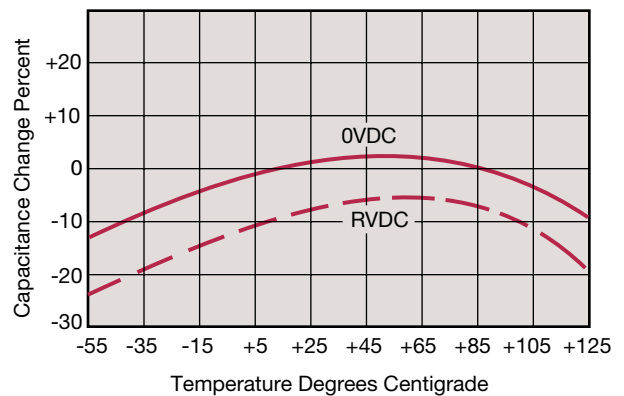

Figure 5

Effects of Time – Class 2 ceramic capacitors change capacitance and dissipation factor with time as well as temperature, voltage and frequency. This change with time is known as aging. Aging is caused by a gradual re-alignment of the crystalline structure of the ceramic and produces an exponential loss in capacitance and decrease in dissipation factor versus time. A typical curve of aging rate for semi-stable ceramics is shown in Figure 6.

If a Class 2 ceramic capacitor that has been sitting on the shelf for a period of time, is heated above its curie point, (125°C for 4 hours or 150°C for ½ hour will suffice) the part will de-age and return to its initial capacitance and dissipation factor readings. Because the capacitance changes rapidly, immediately after de-aging, the basic capacitance measurements are normally referred to a time period sometime after the de-aging process. Various manufacturers use different time bases but the most popular one is one day or twenty-four hours after “last heat.” Change in the aging curve can be caused by the application of voltage and other stresses. The possible changes in capacitance due to de-aging by heating the unit explain why capacitance changes are allowed after test, such as temperature cycling, moisture resistance, etc., in MIL specs. The application of high voltages such as dielectric withstanding voltages also

tends to de-age capacitors and is why re-reading of capacitance after 12 or 24 hours is allowed in military specifications after dielectric strength tests have been performed.

**Typical Curve of Aging Rate
X7R Dielectric**

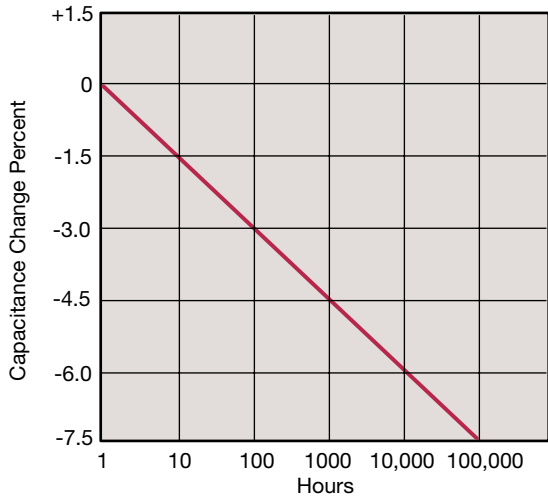

| Characteristic | Max. Aging Rate %/Decade |
|----------------|--------------------------|
| C0G (NPO) | None |
| X7R | 2 |
| Z5U | 3 |
| Y5V | 5 |

Figure 6

Effects of Frequency – Frequency affects capacitance and impedance characteristics of capacitors. This effect is much more pronounced in high dielectric constant ceramic formulation that is low K formulations. AVX’s SpiCap software generates impedance, ESR, series inductance, series resonant frequency and capacitance all as functions of frequency, temperature and DC bias for standard chip sizes and styles. It is available free from AVX.



Effects of Mechanical Stress – High “K” dielectric ceramic capacitors exhibit some low level piezoelectric reactions under mechanical stress. As a general statement, the piezoelectric output is higher, the higher the dielectric constant of the ceramic. It is desirable to investigate this effect before using high “K” dielectrics as coupling capacitors in extremely low level applications.

Reliability – Historically ceramic capacitors have been one of the most reliable types of capacitors in use today. The approximate formula for the reliability of a ceramic capacitor is:

$$\frac{L_o}{L_t} = \left(\frac{V_t}{V_o}\right)^X \left(\frac{T_t}{T_o}\right)^Y$$

where

- L_o = operating life
- L_t = test life
- V_t = test voltage
- V_o = operating voltage
- T_t = test temperature and
- T_o = operating temperature in °C
- X, Y = see text

Historically for ceramic capacitors exponent X has been considered as 3. The exponent Y for temperature effects typically tends to run about 8.

A capacitor is a component which is capable of storing electrical energy. It consists of two conductive plates (electrodes) separated by insulating material which is called the dielectric. A typical formula for determining capacitance is:

$$C = \frac{.224 KA}{t}$$

- C = capacitance (picofarads)
- K = dielectric constant (Vacuum = 1)
- A = area in square inches
- t = separation between the plates in inches (thickness of dielectric)
- $.224$ = conversion constant (.0884 for metric system in cm)

Capacitance – The standard unit of capacitance is the farad. A capacitor has a capacitance of 1 farad when 1 coulomb charges it to 1 volt. One farad is a very large unit and most capacitors have values in the micro (10^{-6}), nano (10^{-9}) or pico (10^{-12}) farad level.

Dielectric Constant – In the formula for capacitance given above the dielectric constant of a vacuum is arbitrarily chosen as the number 1. Dielectric constants of other materials are then compared to the dielectric constant of a vacuum.

Dielectric Thickness – Capacitance is indirectly proportional to the separation between electrodes. Lower voltage requirements mean thinner dielectrics and greater capacitance per volume.

Area – Capacitance is directly proportional to the area of the electrodes. Since the other variables in the equation are usually set by the performance desired, area is the easiest parameter to modify to obtain a specific capacitance within a material group.

Energy Stored – The energy which can be stored in a capacitor is given by the formula:

$$E = \frac{1}{2}CV^2$$

E = energy in joules (watts-sec)
V = applied voltage
C = capacitance in farads

Potential Change – A capacitor is a reactive component which reacts against a change in potential across it. This is shown by the equation for the linear charge of a capacitor:

$$I_{ideal} = C \frac{dV}{dt}$$

where

I = Current
C = Capacitance
dV/dt = Slope of voltage transition across capacitor

Thus an infinite current would be required to instantly change the potential across a capacitor. The amount of current a capacitor can “sink” is determined by the above equation.

Equivalent Circuit – A capacitor, as a practical device, exhibits not only capacitance but also resistance and inductance. A simplified schematic for the equivalent circuit is:

C = Capacitance **L** = Inductance
R_s = Series Resistance **R_p** = Parallel Resistance

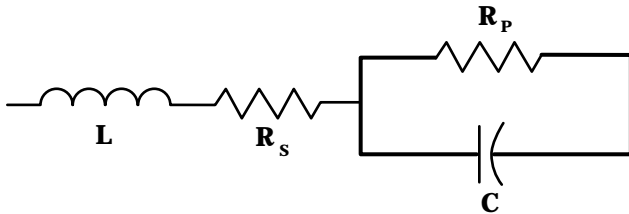

Reactance – Since the insulation resistance (**R_p**) is normally very high, the total impedance of a capacitor is:

$$Z = \sqrt{R_s^2 + (X_c - X_L)^2}$$

where

Z = Total Impedance
R_s = Series Resistance
X_c = Capacitive Reactance = $\frac{1}{2\pi fC}$
X_L = Inductive Reactance = $2\pi fL$

The variation of a capacitor’s impedance with frequency determines its effectiveness in many applications.

Phase Angle – Power Factor and Dissipation Factor are often confused since they are both measures of the loss in a capacitor under AC application and are often almost identical in value. In a “perfect” capacitor the current in the capacitor will lead the voltage by 90°.

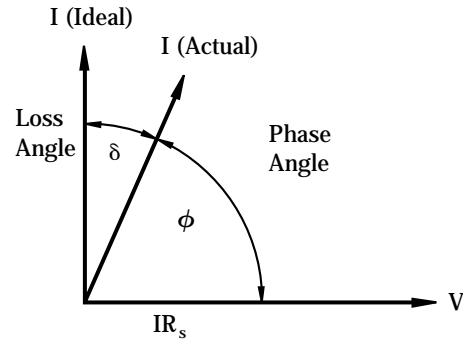

In practice the current leads the voltage by some other phase angle due to the series resistance **R_s**. The complement of this angle is called the loss angle and:

Power Factor (P.F.) = Cos ϕ or Sine δ
Dissipation Factor (D.F.) = tan δ

for small values of δ the tan and sine are essentially equal which has led to the common interchangeability of the two terms in the industry.

Equivalent Series Resistance – The term E.S.R. or Equivalent Series Resistance combines all losses both series and parallel in a capacitor at a given frequency so that the equivalent circuit is reduced to a simple R-C series connection.

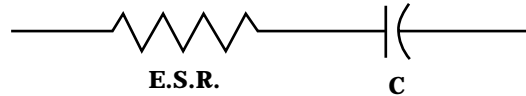

Dissipation Factor – The DF/PF of a capacitor tells what percent of the apparent power input will turn to heat in the capacitor.

$$\text{Dissipation Factor} = \frac{\text{E.S.R.}}{X_c} = (2\pi fC) (\text{E.S.R.})$$

The watts loss are:

$$\text{Watts loss} = (2\pi fCV^2) (\text{D.F.})$$

Very low values of dissipation factor are expressed as their reciprocal for convenience. These are called the “Q” or Quality factor of capacitors.

Parasitic Inductance – The parasitic inductance of capacitors is becoming more and more important in the decoupling of today’s high speed digital systems. The relationship between the inductance and the ripple voltage induced on the DC voltage line can be seen from the simple inductance equation:

$$V = L \frac{di}{dt}$$

The $\frac{di}{dt}$ seen in current microprocessors can be as high as 0.3 A/ns, and up to 10A/ns. At 0.3 A/ns, 100pH of parasitic inductance can cause a voltage spike of 30mV. While this does not sound very drastic, with the Vcc for microprocessors decreasing at the current rate, this can be a fairly large percentage.

Another important, often overlooked, reason for knowing the parasitic inductance is the calculation of the resonant frequency. This can be important for high frequency, bypass capacitors, as the resonant point will give the most signal attenuation. The resonant frequency is calculated from the simple equation:

$$f_{res} = \frac{1}{2\pi\sqrt{LC}}$$

Insulation Resistance – Insulation Resistance is the resistance measured across the terminals of a capacitor and consists principally of the parallel resistance R_P shown in the equivalent circuit. As capacitance values and hence the area of dielectric increases, the I.R. decreases and hence the product (C x IR or RC) is often specified in ohm farads or more commonly megohm-microfarads. Leakage current

is determined by dividing the rated voltage by IR (Ohm's Law).

Dielectric Strength – Dielectric Strength is an expression of the ability of a material to withstand an electrical stress. Although dielectric strength is ordinarily expressed in volts, it is actually dependent on the thickness of the dielectric and thus is also more generically a function of volts/mil.

Dielectric Absorption – A capacitor does not discharge instantaneously upon application of a short circuit, but drains gradually after the capacitance proper has been discharged. It is common practice to measure the dielectric absorption by determining the “reappearing voltage” which appears across a capacitor at some point in time after it has been fully discharged under short circuit conditions.

Corona – Corona is the ionization of air or other vapors which causes them to conduct current. It is especially prevalent in high voltage units but can occur with low voltages as well where high voltage gradients occur. The energy discharged degrades the performance of the capacitor and can in time cause catastrophic failures.

Surface Mounting Guide



MLC Chip Capacitors

Component Pad Design

Component pads should be designed to achieve good solder filets and minimize component movement during reflow soldering. Pad designs are given below for the most common sizes of multilayer ceramic capacitors for both wave and reflow soldering. The basis of these designs is:

- Pad width equal to component width. It is permissible to decrease this to as low as 85% of component width but it is not advisable to go below this.
- Pad overlap 0.5mm beneath component.
- Pad extension 0.5mm beyond components for reflow and 1.0mm for wave soldering.

REFLOW SOLDERING

| Case Size | D1 | D2 | D3 | D4 | D5 |
|-------------|-------------|--------------|-------------|-------------|-------------|
| 0402 | 1.70 (0.07) | 0.60 (0.02) | 0.50 (0.02) | 0.60 (0.02) | 0.50 (0.02) |
| 0603 | 2.30 (0.09) | 0.80 (0.03) | 0.70 (0.03) | 0.80 (0.03) | 0.75 (0.03) |
| 0805 | 3.00 (0.12) | 1.00 (0.04) | 1.00 (0.04) | 1.00 (0.04) | 1.25 (0.05) |
| 1206 | 4.00 (0.16) | 1.00 (0.04) | 2.00 (0.09) | 1.00 (0.04) | 1.60 (0.06) |
| 1210 | 4.00 (0.16) | 1.00 (0.04) | 2.00 (0.09) | 1.00 (0.04) | 2.50 (0.10) |
| 1808 | 5.60 (0.22) | 1.00 (0.04) | 3.60 (0.14) | 1.00 (0.04) | 2.00 (0.08) |
| 1812 | 5.60 (0.22) | 1.00 (0.04)) | 3.60 (0.14) | 1.00 (0.04) | 3.00 (0.12) |
| 1825 | 5.60 (0.22) | 1.00 (0.04) | 3.60 (0.14) | 1.00 (0.04) | 6.35 (0.25) |
| 2220 | 6.60 (0.26) | 1.00 (0.04) | 4.60 (0.18) | 1.00 (0.04) | 5.00 (0.20) |
| 2225 | 6.60 (0.26) | 1.00 (0.04) | 4.60 (0.18) | 1.00 (0.04) | 6.35 (0.25) |

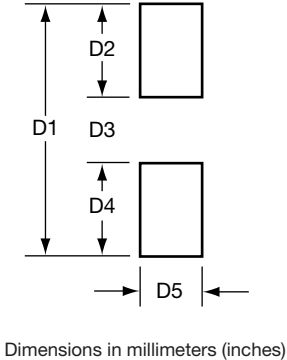

WAVE SOLDERING

| Case Size | D1 | D2 | D3 | D4 | D5 |
|-------------|-------------|-------------|-------------|-------------|-------------|
| 0603 | 3.10 (0.12) | 1.20 (0.05) | 0.70 (0.03) | 1.20 (0.05) | 0.75 (0.03) |
| 0805 | 4.00 (0.15) | 1.50 (0.06) | 1.00 (0.04) | 1.50 (0.06) | 1.25 (0.05) |
| 1206 | 5.00 (0.19) | 1.50 (0.06) | 2.00 (0.09) | 1.50 (0.06) | 1.60 (0.06) |
| 1210 | 5.00 (0.19) | 1.50 (0.06) | 2.00 (0.09) | 1.50 (0.06) | 2.50 (0.10) |

Dimensions in millimeters (inches)

Component Spacing

For wave soldering components, must be spaced sufficiently far apart to avoid bridging or shadowing (inability of solder to penetrate properly into small spaces). This is less important for reflow soldering but sufficient space must be allowed to enable rework should it be required.

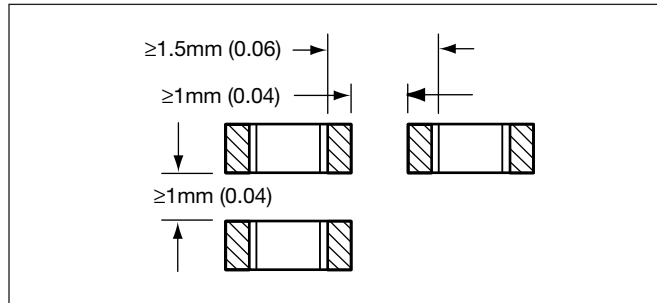

Preheat & Soldering

The rate of preheat should not exceed 4°C/second to prevent thermal shock. A better maximum figure is about 2°C/second.

For capacitors size 1206 and below, with a maximum thickness of 1.25mm, it is generally permissible to allow a temperature differential from preheat to soldering of 150°C. In all other cases this differential should not exceed 100°C.

For further specific application or process advice, please consult AVX.

Cleaning

Care should be taken to ensure that the capacitors are thoroughly cleaned of flux residues especially the space beneath the capacitor. Such residues may otherwise become conductive and effectively offer a low resistance bypass to the capacitor.

Ultrasonic cleaning is permissible, the recommended conditions being 8 Watts/litre at 20-45 kHz, with a process cycle of 2 minutes vapor rinse, 2 minutes immersion in the ultrasonic solvent bath and finally 2 minutes vapor rinse.

Surface Mounting Guide



MLC Chip Capacitors

APPLICATION NOTES

Storage

Good solderability is maintained for at least twelve months, provided the components are stored in their "as received" packaging at less than 40°C and 70% RH.

Solderability

Terminations to be well soldered after immersion in a 60/40 tin/lead solder bath at 235 ±5°C for 2±1 seconds.

Leaching

Terminations will resist leaching for at least the immersion times and conditions shown below.

| Termination Type | Solder Tin/Lead/Silver | Solder Temp. °C | Immersion Time Seconds |
|------------------|------------------------|-----------------|------------------------|
| Nickel Barrier | 60/40/0 | 260±5 | 30±1 |

Recommended Soldering Profiles

Reflow

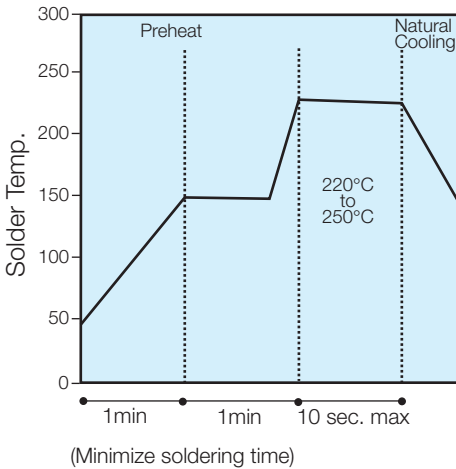

Wave

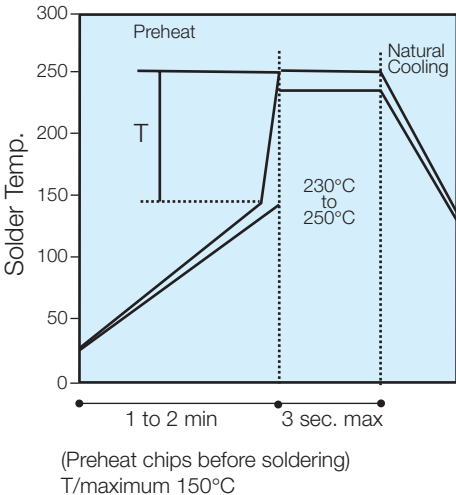

General

Surface mounting chip multilayer ceramic capacitors are designed for soldering to printed circuit boards or other substrates. The construction of the components is such that they will withstand the time/temperature profiles used in both wave and reflow soldering methods.

Handling

Chip multilayer ceramic capacitors should be handled with care to avoid damage or contamination from perspiration and skin oils. The use of tweezers or vacuum pick ups is strongly recommended for individual components. Bulk handling should ensure that abrasion and mechanical shock are minimized. Taped and reeled components provides the ideal medium for direct presentation to the placement machine. Any mechanical shock should be minimized during handling chip multilayer ceramic capacitors.

Preheat

It is important to avoid the possibility of thermal shock during soldering and carefully controlled preheat is therefore required. The rate of preheat should not exceed 4°C/second and a target figure 2°C/second is recommended. Although an 80°C to 120°C temperature differential is preferred, recent developments allow a temperature differential between the component surface and the soldering temperature of 150°C (Maximum) for capacitors of 1210 size and below with a maximum thickness of 1.25mm. The user is cautioned that the risk of thermal shock increases as chip size or temperature differential increases.

Soldering

Mildly activated rosin fluxes are preferred. The minimum amount of solder to give a good joint should be used. Excessive solder can lead to damage from the stresses caused by the difference in coefficients of expansion between solder, chip and substrate. AVX terminations are suitable for all wave and reflow soldering systems. If hand soldering cannot be avoided, the preferred technique is the utilization of hot air soldering tools.

Cooling

Natural cooling in air is preferred, as this minimizes stresses within the soldered joint. When forced air cooling is used, cooling rate should not exceed 4°C/second. Quenching is not recommended but if used, maximum temperature differentials should be observed according to the preheat conditions above.

Cleaning

Flux residues may be hygroscopic or acidic and must be removed. AVX MLC capacitors are acceptable for use with all of the solvents described in the specifications MIL-STD-202 and EIA-RS-198. Alcohol based solvents are acceptable and properly controlled water cleaning systems are also acceptable. Many other solvents have been proven successful, and most solvents that are acceptable to other components on circuit assemblies are equally acceptable for use with ceramic capacitors.

