

User's Guide

NHD-4.3-480272ZF-ATXI#-T-1 TFT

(Liquid Crystal Display Graphic Module)
Touch Panel

4.3" Diagonal
16-bit digital interface
480x272 Resolution
White LED Backlight

Please review the driver spec HX8257-A .

Tel: (847) 844-8795 Fax: (847) 844-8796

Newhaven Display International
2511 Technology Drive, #101
Elgin, IL 60124

April 3, 2009

STANDARD DOC.	PRODUCT SPEC.	MODULE NO.		PAGE	2
------------------	------------------	---------------	--	------	---

CONTENTS

1.	GENERAL SPECIFICATIONS	-----	2
2.	FEATURES	-----	2
3.	MECHANICAL SPECIFICATIONS	-----	2
4.	OUTLINE DIMENSIONS	-----	4
5.	INTERFACE ASSIGNMENT	-----	5
6.	APPLICATION CIRCUIT	-----	6
7.	BLOCK DIAGRAM	-----	6
8.	TIMING CHARACTERISTICS	-----	7
9.	RESET TIMING CHARACTERISTICS	-----	9
10.	POWER ON/OFF SEQUENCE	-----	10
11.	ABSOLUTE MAXIMUM RATINGS	-----	11
12.	ELECTRICAL CHARACTERISTICS	-----	11
13.	LED BACKLIGHT CHARACTERISTICS	-----	12
14.	OPTICAL CHARACTERISTICS	-----	13
15.	ENVIRONMENTAL ABSOLUTE MAXIMUM RATINGS	-----	16
16.	RELIABILITY TEST	-----	16
17.	THE STANDARD OF INSPECTION	-----	17
18.	USING LCD MODULES	-----	20

1. GENERAL SPECIFICATIONS

1-1 SCOPE:

This specification covers the delivery requirements for the liquid crystal display delivered by Newhaven to Customer

1-2 PRODUCTS:

Liquid Crystal Display Module (LCM)

1-3 MODULE NAME:

NHD-4.3-480272ZF-ATXI#-T-1

2. FEATURES

- (1) Display Type: 4.3" a-Si TFT; 480RGB*272dots; 12 O'clock; transmissive; normally white; ,
- (2) Driving Method: TFT
- (3) Built-in driver:HX8257-A
- (4) With WHITE LED Backlight

3. MECHANICAL SPECIFICATIONS

ITEM	SPECIFICATIONS	UNIT
OUTLINE DIMENSIONS	105.5(W) x67.2(H) x3.8(T)	mm
ACTIVE AREA	95.04 (W) x53.86(H)	mm
DISP.CONSTRUCTION	480(RGB) x272 s t o D	---
DOT PITCH	0.198 X 0.198	mm
ASSY.TYPE	COG+FPC+BL+TP	---
BACKLIGHT	WHITE LED	—
WEIGHT	TBD	g



5. INTERFACE ASSIGNMENT

PIN NO.	FUNCTION DESCRIPTIONS	SYMBOL
1	Backlight Cathode	VLED-
2	Backlight Anode	VLED+
3	GROUND	GND
4	Supply Voltage = 3.3V	
5	Red data signal(LSB)	R0
6	Red data signal	R1
7	Red data signal	R2
8	Red data signal	R3
9	Red data signal	R4
10	Red data signal	R5
11	Red data signal	R6
12	Red data signal(MSB)	R7
13	Green data signal(LSB)	G0
14	Green data signal	G1
15	Green data signal	G2
16	Green data signal	G3
17	Green data signal	G4
18	Green data signal	G5
19	Green data signal	G6
20	Green data signal(MSB)	G7
21	Blue data signal(LSB)	B0
22	Blue data signal	B1
23	Blue data signal	B2
24	Blue data signal	B3
25	Blue data signal	B4
26	Blue data signal	B5
27	Blue data signal	B6
28	Blue data signal(MSB)	B7
29	GROUND	GND
30	Clock signal to sample each data	PCLK
31	Display on/off signal (this pin is pulled high in internally)	DISP
32	Horizontal synchronizing signal	HSYNC
33	Vertical synchronizing signal	VSYNC
34	Input data enable control. Internally pulled low.	DE
35	No Connect	
36	GROUND	GND
37	TOUCH PANEL INTERFACE FOR XR	XR
38	TOUCH PANEL INTERFACE FOR YD	YD
39	TOUCH PANEL INTERFACE FOR XL	XL
40	TOUCH PANEL INTERFACE FOR YU	YU

VDD

AVDD

6.APPLICATION CIRCUIT

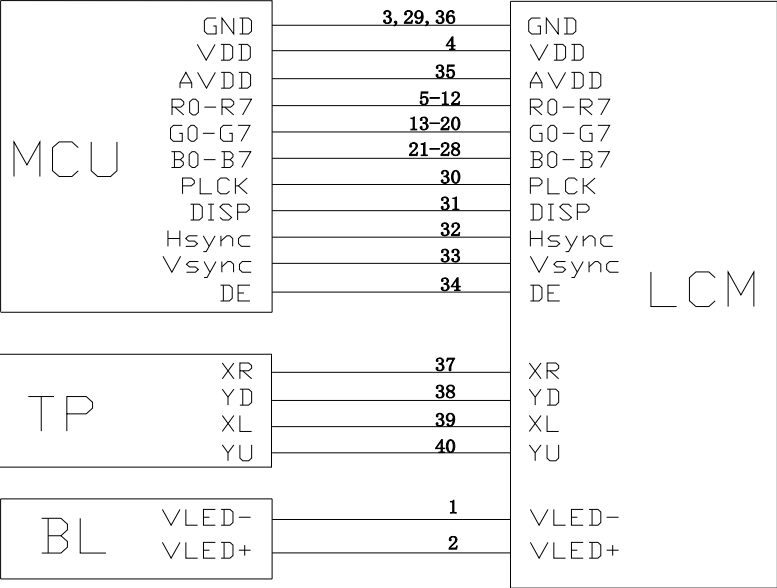

7. BLOCK DIAGRAM

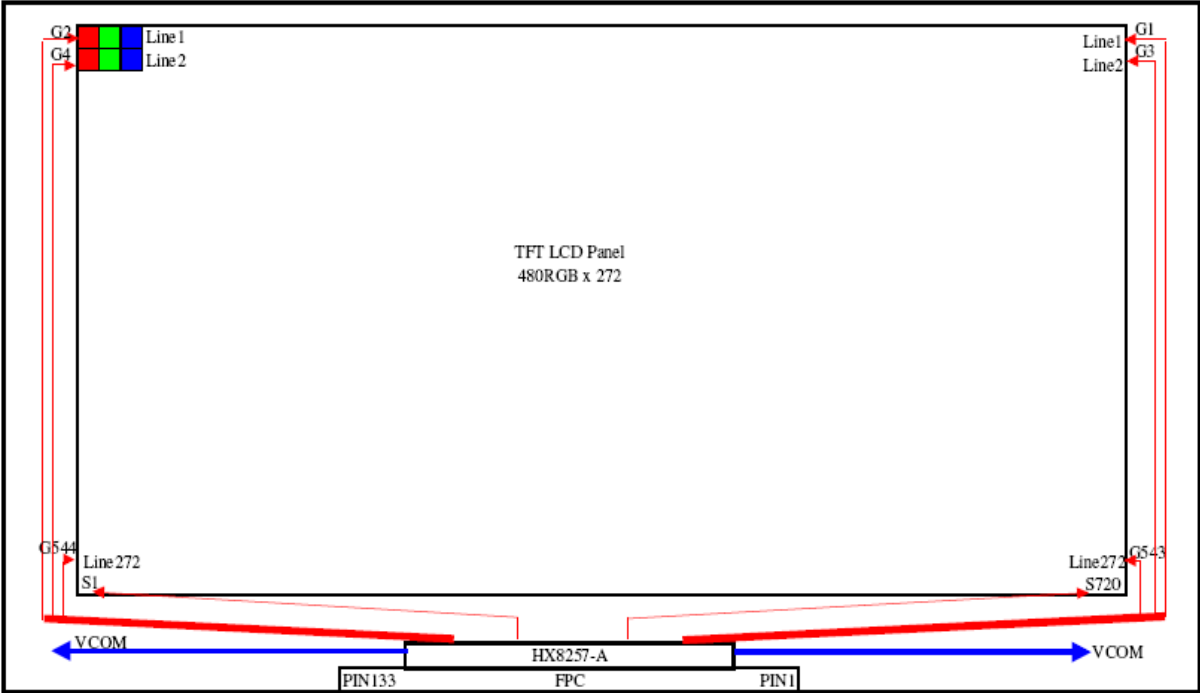

8.TIMING CHARACTERISTICS

8.1 Parallel RGB input t requirement

(480RGBx272, T_A=25°C, VDDIO=1.8V to 3.6V, DVSS= 0V)

Parameter	Symbol	Spec.			Unit
		Min.	Typ.	Max.	
Clock cycle	f _{CLK} ⁽¹⁾	-	9	15	MHz
Hsync cycle	1/th	-	17.14	-	KHz
Vsync cycle	1/tv	-	59.94	-	Hz
Horizontal Signal					
Horizontal cycle	th	525	525	605	CLK
Horizontal display period	thd	480	480	480	CLK
Horizontal front porch	thf	2	2	82	CLK
Horizontal pulse width	thp ⁽²⁾	2	41	41	CLK
Horizontal back porch	thb ⁽²⁾	2	2	41	CLK
Vertical Signal					
Vertical cycle	tv	285	286	511	H ⁽¹⁾
Vertical display period	tvd	272	272	272	H ⁽¹⁾
Vertical front porch	tvf	1	2	227	H ⁽¹⁾
Vertical pulse width	tvp ⁽²⁾	1	10	11	H ⁽¹⁾
Vertical back porch	tvb ⁽²⁾	1	2	11	H ⁽¹⁾

Note: (1) Unit: CLK=1/ f_{CLK}, H=th,
(2)It is necessary to keep tvp+tvb=12 and thp+thb=43 in sync mode. DE mode is unnecessary to keep it.

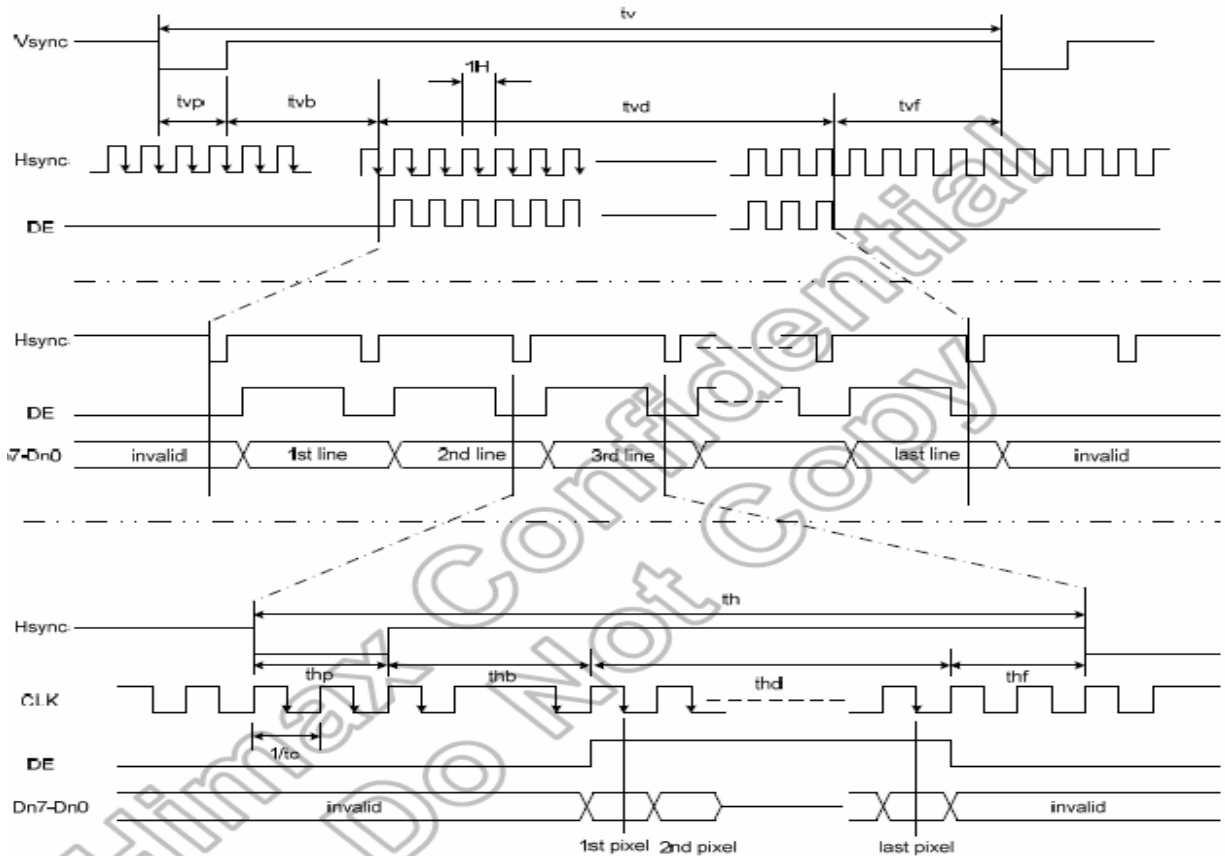

Figure 11.1 Parallel RGB Input Timing

8.2 Serial RGB input requirement

(480RGBx272, T_A=25°C, VDDIO=1.8V to 3.6V, DVSS= 0V)

Parameter	Symbol	Spec.			Unit
		Min.	Typ.	Max.	
Clock cycle	f _{CLK} ⁽¹⁾	-	27	33	MHz
Hsync cycle	1/th	-	17.14	-	KHz
Vsync cycle	1/tv	-	59.94	-	Hz
Horizontal Signal					
Horizontal cycle	th	1575	1575	1815	CLK
Horizontal display period	thd	1440	1440	1440	CLK
Horizontal front porch	thf	6	6	246	CLK
Horizontal pulse width	thp	6	123	123	CLK
Horizontal back porch	thb	6	6	123	CLK
Vertical Signal					
Vertical cycle	tv	285	286	511	H ⁽¹⁾
Vertical display period	tvd	272	272	272	H ⁽¹⁾
Vertical front porch	tvf	1	2	227	H ⁽¹⁾
Vertical pulse width	tv _p	1	10	11	H ⁽¹⁾
Vertical back porch	tv _b	1	2	11	H ⁽¹⁾

Note: (1) Unit: CLK=1/ f_{CLK}, H=th

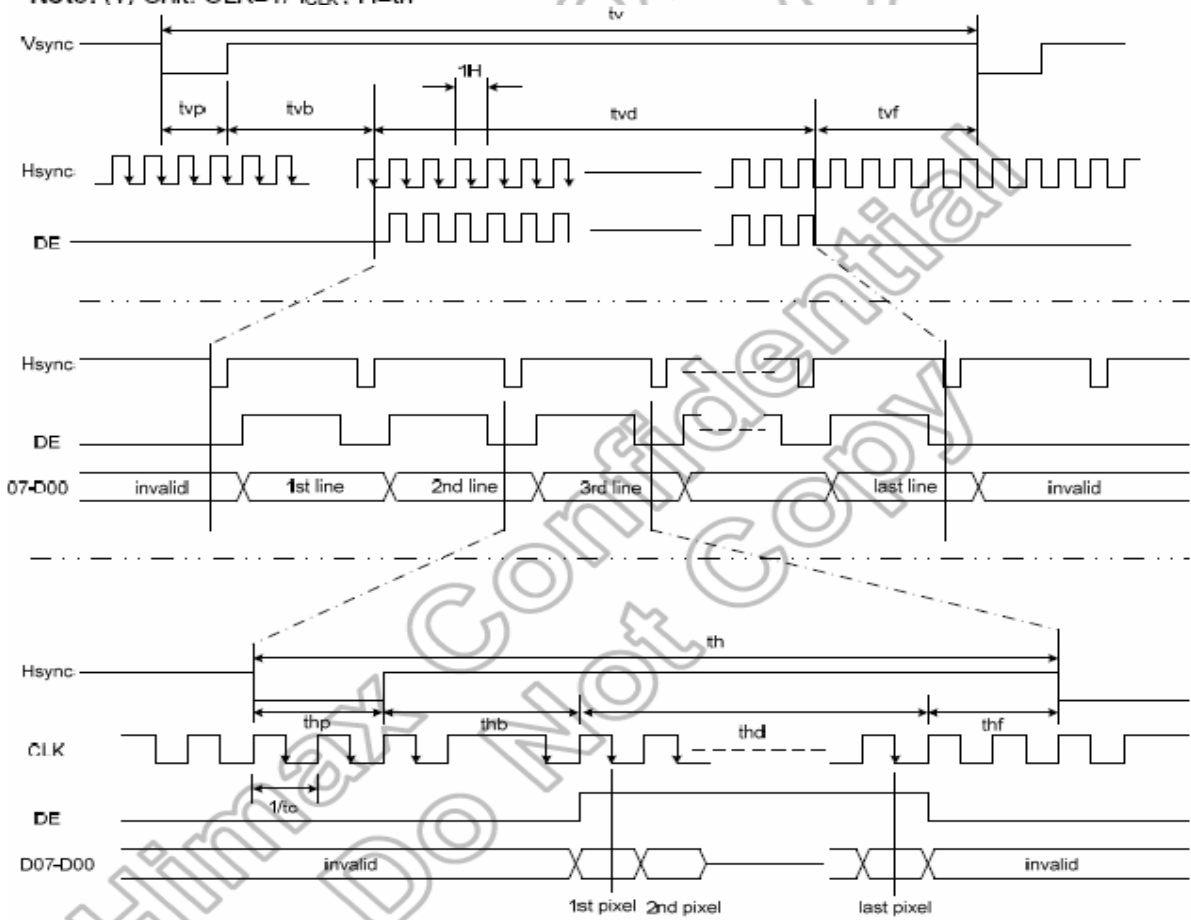
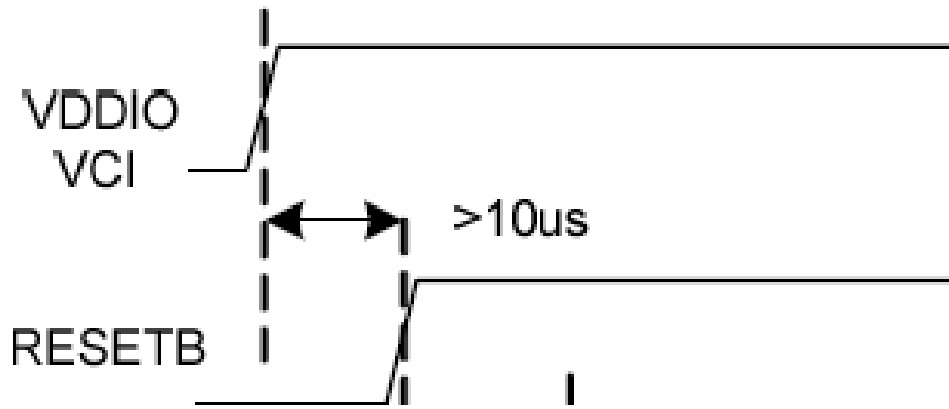

Figure 11.2 Serial RGB Input Timing

9.RESET TIMING CHARACTERISTICS



10. POWER ON/OFF SEQUENCE

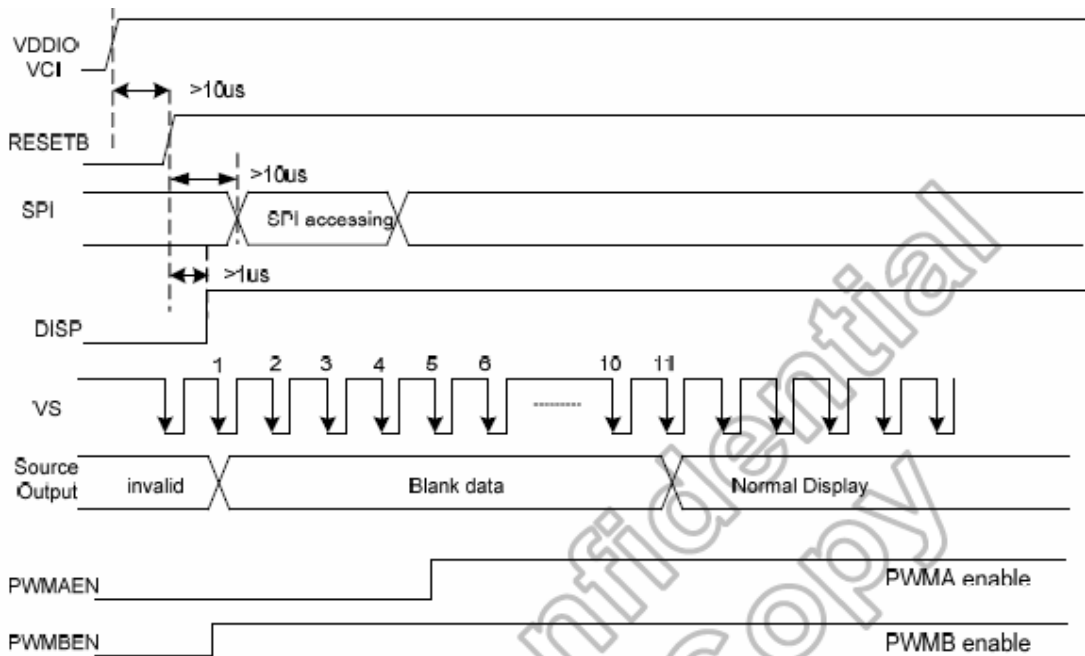

Figure 7.14 Power On Sequence

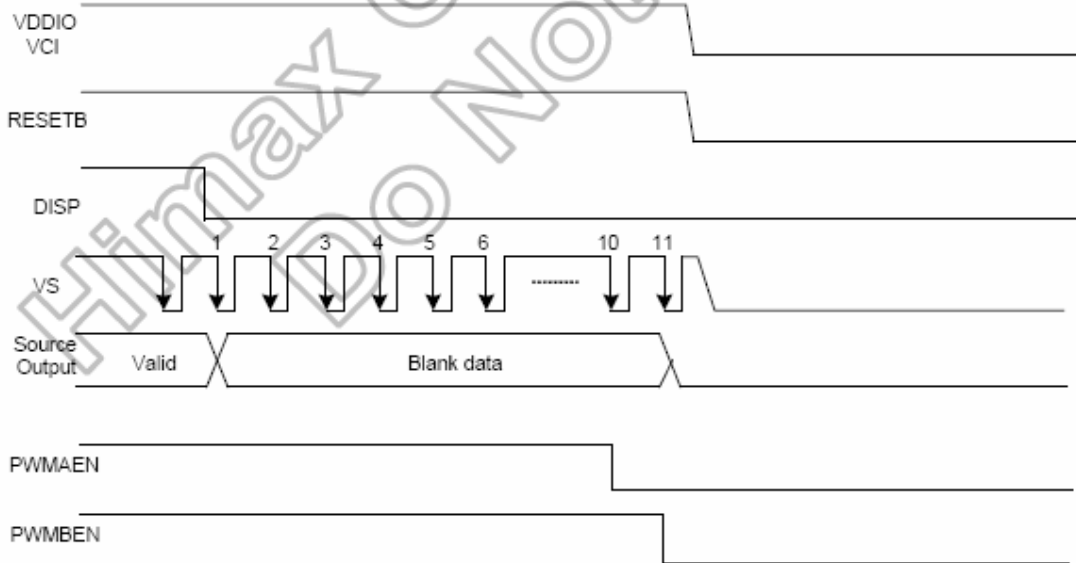

Figure 7.15 Power Off Sequence

11. ABSOLUTE MAXIMUM RATING

ITEM	SYMBOL	CONDITION	STANDARD VALUE			UNIT
			MIN	TYP	MAX	
POWER SUPPLY FOR LOGIC	IOVCC	Ta=25℃	-0.3	---	+3.6	V
INPUT VOLTAGE	VIN	Ta=25℃	-0.3	---	VCI+0.3	V
OPERATION TEMPERATURE	TOPR	---	-20	---	+60	℃
STORAGE TEMPERATURE	TSTG	---	-30	---	+70	℃

12. ELECTRICAL CHARACTERISTICS

ITEM	SYMBOL	CONDITIONS	STANDARD VALUE			UNIT
			MIN	TYP	MAX	
POWER SUPPLY VOLTAGE	VDD—VSS	Ta= +25℃	-	3.3	-	V
INPUT VOLTAGE "H" LEVEL	VIH	—	0.8VDD	—	VDD	V
INPUT VOLTAGE "L" LEVEL	VIL	—	VSS	—	0.2VDD	V
OUTPUT VOLTAGE "H" LEVEL	VOH	IOH=200uA	VDD-0.3	—	VDD	V
OUTPUT VOLTAGE "L" LEVEL	VOL	IOL=200uA	VSS	—	VSS+0.3	V

13. LED BACKLIGHT

13-1 POWER SUPPLY FOR LED BACKLIGHT

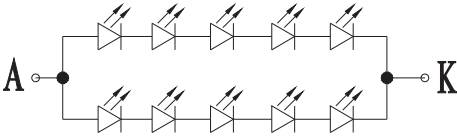

13-2 ABSOLUTE MAXIMUM RATING

PARAMETER	SYMBOL	SPECIFICATIONS	UNIT
POWER DISSIPATION	PD	850	mW
FORWARD CURRENT	IFm	50	mA
REVERSE VOLTAGE	VF	5/LED	V
OPERATION TEMPERATURE	TOPR	-20℃ ~ +70℃	℃
STORAGE TEMPERATURE	TSTG	-30℃ ~ +80℃	℃

13-3 ELECTRICAL CHARACTERISTICS

PARAMETER	SYMBOL	LIGHT SOURCE	CONDITIONS	STANDARD VALUE			UNIT
				MIN	TYP	MAX	
PARAMETER	VF	WHITE	IF =40mA	15	16	17	V
LUMINOUS INTENSITY	lv	WHITE	IF =40mA	230	250	1	cd/m ²
Color of CIE(1931) coordinate	X	WHITE		0.26	1	0.31	nm
	Y	WHITE		0.26	1	0.31	nm

14.OPTICAL CHARACTERISTICS

Item	Symbol	Conditions	Specifications			Unit	Note	
			Min.	Typ.	Max.			
Transmittance	T%	Viewing normal angle $\theta_x = \theta_y$ $=0^\circ$		7.1		%	All left side data are based on CMO's following condition – 6 o'clock NTSC: 50% LC: TN Light : C light (Machine:BM5A) Normal Polarizer Reference Only	
Contrast Ratio	CR			250		-		
Response Time	T_R			TBD		ms		
	T_F			TBD		ms		
Chromaticity	Red		X_R		TBD			-
			Y_R		TBD			-
	Green		X_G		TBD			-
			Y_G		TBD			-
	Blue		X_B		TBD			-
			Y_B		TBD			-
White	X_W		TBD		-			
	Y_W		TBD		-			
Viewing Angle	Hor.	θ_{x+}		45		deg.		
		θ_{x-}		45				
	Ver.	θ_{y+}		15				
		θ_{y-}		35				
		Center CR \geq 10						

--

(1) DEFINITION OF VIEWING ANGLE

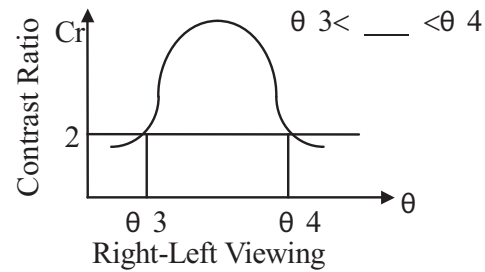
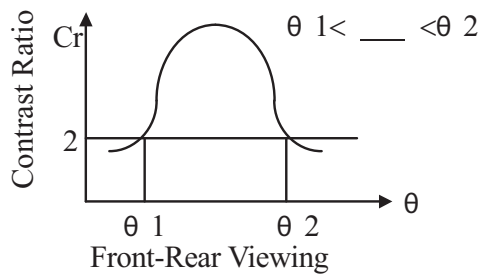
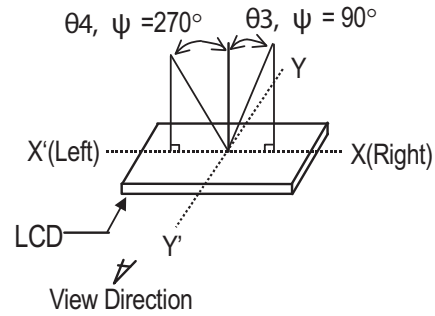
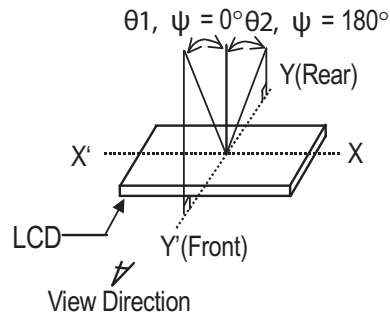

(2) DEFINITION OF CONTRAST

$$C.R = \frac{\text{Brightness of non-selected segment (B2)}}{\text{Brightness of selected segment (B1)}}$$

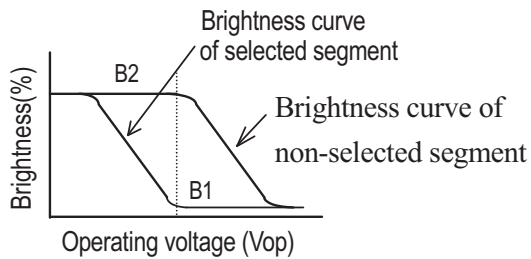

(3) DEFINITION OF RESPONSE

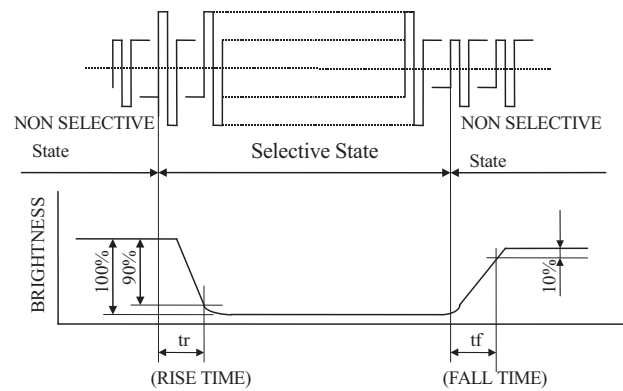

(4) MEASURING INSTRUMENTS FOR ELECTRO-OPTICAL CHARACTERISTICS

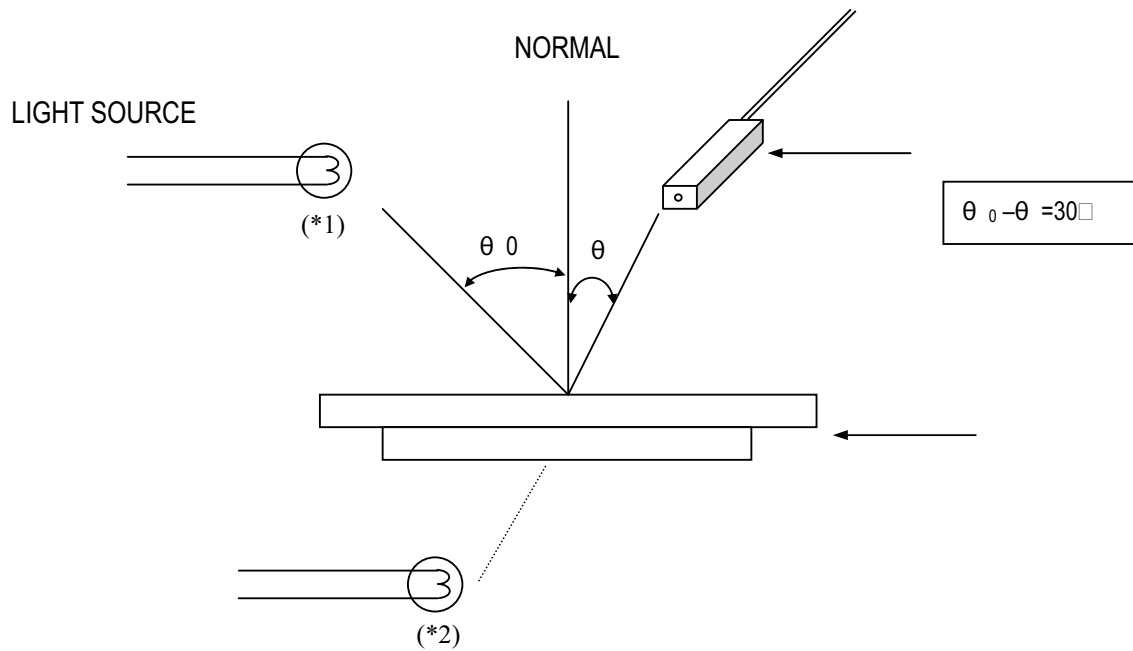

*1.Light source position for measuring the reflective type of LCD panel

*2.Light source position for measuring the transreflective / transmissive types of LCD panel

15. ENVIRONMENTAL ABSOLUTE MAXIMUM RATINGS

ITEM	SYMBOL	CONDITIONS	CRITERION
OPERATING TEMPERATURE	TOPR	-20℃ ~ +60℃	NO DEFECT IN DISPLAYING AND OPERATIONAL FUNCTION
STORAGE TEMPERATURE	TSTG	-30℃ ~ +70℃	NO DEFECT IN DISPLAYING AND OPERATIONAL FUNCTION
HUMIDITY	—	See Note	WITHOUT CONDENSATION

*NOTE: TEST CONDITION

(1)TEMPERATURE AND HUMIDITY: IF NO SPECIFICATION, TEMP. SET AT 25±2℃; HUMIDITY SET AT 60±5%RH

(2) OPERATING STATE: SAMPLES SUBJECT TO THE TESTS SHALL BE IN "OPERATING" CONDITION

*NOTE: TEST CONDITION

(1)TEMPERATURE AND HUMIDITY: IF NO SPECIFICATION, TEMP. SET AT 25±2℃; HUMIDITY SET AT 60±5%RH

(2) OPERATING STATE: SAMPLES SUBJECT TO THE TESTS SHALL BE IN "OPERATING" CONDITION

16. RELIABILITY TEST

ITEM	CONDITIONS	CRITERION
OPERATING TEMPERATURE	HIGH TEMPERATURE +70℃ 72HRS	NO DEFECT IN DISPLAYING AND OPERATIONAL FUNCTION
	LOW TEMPERATURE - 20℃ 72HRS	
STORAGE TEMPERATURE	HIGH TEMPERATURE +80℃ 120HRS	NO DEFECT IN DISPLAYING AND OPERATIONAL FUNCTION
	LOW TEMPERATURE - 30℃ 120HRS	
HUMIDITY	40℃ 90%RH 72HRS	NO DEFECT IN DISPLAYING AND OPERATIONAL FUNCTION
VIBRATION	<input checked="" type="checkbox"/> Operating Time: thirty minutes exposure for each direction (X,Y,Z) <input checked="" type="checkbox"/> Sweep Frequency: 10~55Hz (1 min) <input checked="" type="checkbox"/> Amplitude: 1.5mm	NO DEFECT IN DISPLAYING AND OPERATIONAL FUNCTION
THERMAL SHOCK	-20℃ (30mins) ←→+70℃ (30mins) 10 cycles	NO DEFECT IN DISPLAYING AND OPERATIONAL FUNCTION

NOTE: The samples must be free from defect before test, must be restore at room condition at least for 2 hour after reliability test before any inspection.

17.THE STANDARD OF INSPECTION

17-1 Inspection items and specification for appearance (power off)

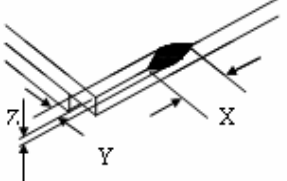
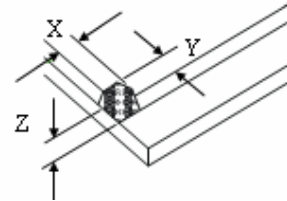
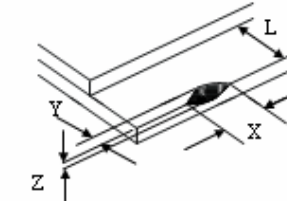
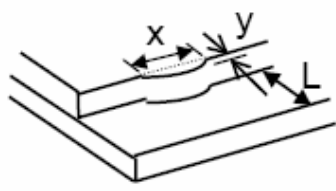
No.	Item	Criterion	AQL																						
1	Dimension	Dimension out of the specification	1.0																						
2	Glass crack	<p>1、 General crack</p>  <table border="1"> <tr> <td>X</td> <td>Y</td> <td>Z</td> </tr> <tr> <td>$\geq K/8$</td> <td>Not over A area</td> <td>$\leq T$</td> </tr> </table> <p>2、 corner</p>  <table border="1"> <tr> <td>X</td> <td>Y</td> <td>Z</td> </tr> <tr> <td>$\geq K/8$</td> <td>Not over A area</td> <td>No check</td> </tr> </table> <p>3、 contact pad crack</p>  <table border="1"> <tr> <td>X</td> <td>Y</td> <td>Z</td> </tr> <tr> <td>$\geq K/8$</td> <td>$\geq L/3$</td> <td>No check</td> </tr> </table> <p>4、 Substrate protuberance and internal crack</p>  <table border="1"> <tr> <td>X</td> <td>Y</td> </tr> <tr> <td>$\geq K/8$</td> <td>$\geq L/3$</td> </tr> </table> <p>Transfer position crack: $\leq L/5$</p>	X	Y	Z	$\geq K/8$	Not over A area	$\leq T$	X	Y	Z	$\geq K/8$	Not over A area	No check	X	Y	Z	$\geq K/8$	$\geq L/3$	No check	X	Y	$\geq K/8$	$\geq L/3$	2.50
X	Y	Z																							
$\geq K/8$	Not over A area	$\leq T$																							
X	Y	Z																							
$\geq K/8$	Not over A area	No check																							
X	Y	Z																							
$\geq K/8$	$\geq L/3$	No check																							
X	Y																								
$\geq K/8$	$\geq L/3$																								

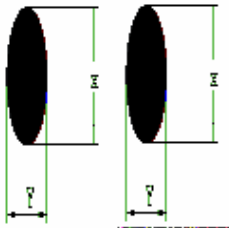
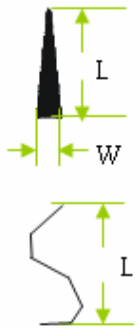
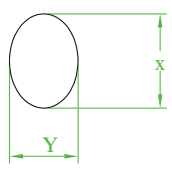
STANDARD DOC.	PRODUCT SPEC.	MODULE NO.		PAGE	18																			
3	Black dot \ White dot	 <table border="1" data-bbox="743 252 1291 493"> <thead> <tr> <th rowspan="2">D</th> <th colspan="2">Acceptable of defect</th> </tr> <tr> <th>A/B Area</th> <th>C Area</th> </tr> </thead> <tbody> <tr> <td>$D < 0.2$</td> <td colspan="2">No check</td> </tr> <tr> <td>$0.2 \leq D < 0.3$</td> <td colspan="2">2</td> </tr> <tr> <td>$0.3 \leq D \leq 0.5$</td> <td colspan="2">1</td> </tr> <tr> <td>$D > 0.5$</td> <td colspan="2">0</td> </tr> </tbody> </table> <p>X: long diameter Y: shot diameter D: average of diameter $D=(X+Y)/2$</p>	D	Acceptable of defect		A/B Area	C Area	$D < 0.2$	No check		$0.2 \leq D < 0.3$	2		$0.3 \leq D \leq 0.5$	1		$D > 0.5$	0		2.50				
D	Acceptable of defect																							
	A/B Area	C Area																						
$D < 0.2$	No check																							
$0.2 \leq D < 0.3$	2																							
$0.3 \leq D \leq 0.5$	1																							
$D > 0.5$	0																							
4	Line defect	 <table border="1" data-bbox="695 693 1291 934"> <thead> <tr> <th rowspan="2">Length</th> <th rowspan="2">Whidth</th> <th colspan="2">Acceptable of defect</th> </tr> <tr> <th>A/B Area</th> <th>C Area</th> </tr> </thead> <tbody> <tr> <td>accept</td> <td>$W \leq 0.02$</td> <td>No check</td> <td rowspan="2">No check</td> </tr> <tr> <td>$L \leq 3$</td> <td>$W \leq 0.05$</td> <td>2</td> </tr> <tr> <td rowspan="2">$L \leq 2.5$</td> <td>$W \leq 0.05$</td> <td>2</td> <td rowspan="2">As round type</td> </tr> <tr> <td>$W > 0.05$</td> <td colspan="2"></td> </tr> </tbody> </table> <p>L: Length W: Width Defect of polarizer (Scratches、Spot) :According to the limit specimen</p>	Length	Whidth	Acceptable of defect		A/B Area	C Area	accept	$W \leq 0.02$	No check	No check	$L \leq 3$	$W \leq 0.05$	2	$L \leq 2.5$	$W \leq 0.05$	2	As round type	$W > 0.05$			2.50	
Length	Whidth	Acceptable of defect																						
		A/B Area	C Area																					
accept	$W \leq 0.02$	No check	No check																					
$L \leq 3$	$W \leq 0.05$	2																						
$L \leq 2.5$	$W \leq 0.05$	2	As round type																					
	$W > 0.05$																							
5	Polarizer Bubble	 <table border="1" data-bbox="711 1186 1291 1438"> <thead> <tr> <th rowspan="2">D</th> <th colspan="2">Acceptable of defect</th> </tr> <tr> <th>A/B Area</th> <th>C Area</th> </tr> </thead> <tbody> <tr> <td>$D \leq 0.2$</td> <td>No check</td> <td rowspan="4">No check</td> </tr> <tr> <td>$0.2 \leq D \leq 0.5$</td> <td>3</td> </tr> <tr> <td>$0.5 \leq D \leq 1.0$</td> <td>2</td> </tr> <tr> <td>$D > 1.0$</td> <td>0</td> </tr> </tbody> </table>	D	Acceptable of defect		A/B Area	C Area	$D \leq 0.2$	No check	No check	$0.2 \leq D \leq 0.5$	3	$0.5 \leq D \leq 1.0$	2	$D > 1.0$	0	2.50							
D	Acceptable of defect																							
	A/B Area	C Area																						
$D \leq 0.2$	No check	No check																						
$0.2 \leq D \leq 0.5$	3																							
$0.5 \leq D \leq 1.0$	2																							
$D > 1.0$	0																							
6	External print of panel	<ol style="list-style-type: none"> Transfigure、 pin hole : same as segment transfinger Print width: print width $\geq 1/2$ standard width is acceptable 	2.50																					
7	Silicon glue	The area of painting silicon glue must cover the ITO circuit.	2.50																					
8	Defect of PCB	<ol style="list-style-type: none"> The char 、 wrong edition、 bresking off circuit、 crack and air-logged orifice are unreceivable for PCB. gold finger of PCB can not be oxidative、 smudgy and broken.. 	2.50																					

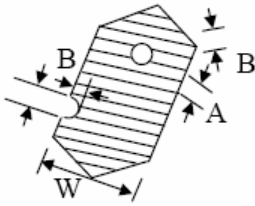
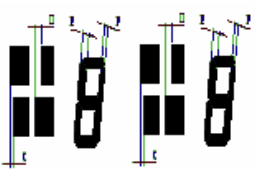
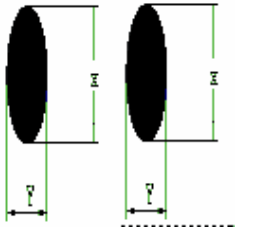
STANDARD DOC.	PRODUCT SPEC.	MODULE NO.		PAGE	19													
9	SMT organ	1、 deflexion of component $\leq 1/3$ width of component 2、 Trying to keep dot of soldering tin orbicular 3、 Damage 、 break、 wrong assembly and unseal are unreceivable for component.			2.50													
10	Steel Frame	1、 Break and distortion are unreceivable for frame. 2、 If there is one nick which can not lead to cast or hole of painting, we allow that following: Length ≤ 5 mm; Width ≤ 0.3 mm			2.50													
17-2 Inspection items and specification for display defect (power on)																		
1	Electrical Defect	Segment missing	Not allow		1.0													
		Segment short	Not allow															
		Non-display	Not allow															
2	Pin hole	1、 Pin hole  <table border="1" data-bbox="782 997 1291 1123"> <thead> <tr> <th>width</th> <th>Acceptable of defect</th> </tr> </thead> <tbody> <tr> <td>$W < 0.4$</td> <td>$D \leq 0.2$ & $D \leq 1/2W$</td> </tr> <tr> <td>$W \geq 0.4$</td> <td>$D \leq 0.25$ & $D \leq 1/3W$</td> </tr> </tbody> </table> * $D = (A+B)/2$ $D \leq 0.1$ acceptable	width	Acceptable of defect	$W < 0.4$	$D \leq 0.2$ & $D \leq 1/2W$	$W \geq 0.4$	$D \leq 0.25$ & $D \leq 1/3W$	2.50									
width	Acceptable of defect																	
$W < 0.4$	$D \leq 0.2$ & $D \leq 1/2W$																	
$W \geq 0.4$	$D \leq 0.25$ & $D \leq 1/3W$																	
3	Display pattern	 <table border="1" data-bbox="782 1281 1291 1396"> <thead> <tr> <th>Width</th> <th>Acceptable of defect</th> </tr> </thead> <tbody> <tr> <td>$W < 0.4$</td> <td>$C, D, G \leq 1/2W$</td> </tr> <tr> <td>$W \geq 0.4$</td> <td>$C, D, G \leq 0.2$</td> </tr> </tbody> </table> W: Design dimension C、 D: discrepant dimension $G = E-F $	Width	Acceptable of defect	$W < 0.4$	$C, D, G \leq 1/2W$	$W \geq 0.4$	$C, D, G \leq 0.2$	1.0									
Width	Acceptable of defect																	
$W < 0.4$	$C, D, G \leq 1/2W$																	
$W \geq 0.4$	$C, D, G \leq 0.2$																	
4	Black/white dot	 <table border="1" data-bbox="782 1522 1291 1764"> <thead> <tr> <th rowspan="2">D</th> <th colspan="2">Acceptable QTY</th> </tr> <tr> <th>A/B Area</th> <th>C Area</th> </tr> </thead> <tbody> <tr> <td>$D < 0.1$</td> <td>No check</td> <td rowspan="4">No check</td> </tr> <tr> <td>$0.1 \leq D < 0.2$</td> <td>2</td> </tr> <tr> <td>$0.2 \leq D \leq 0.25$</td> <td>1</td> </tr> <tr> <td>$D > 0.25$</td> <td>0</td> </tr> </tbody> </table> X: long diameter Y: shot diameter D: average diameter $D = (X+Y)/2$	D	Acceptable QTY		A/B Area	C Area	$D < 0.1$	No check	No check	$0.1 \leq D < 0.2$	2	$0.2 \leq D \leq 0.25$	1	$D > 0.25$	0	2.50	
D	Acceptable QTY																	
	A/B Area	C Area																
$D < 0.1$	No check	No check																
$0.1 \leq D < 0.2$	2																	
$0.2 \leq D \leq 0.25$	1																	
$D > 0.25$	0																	

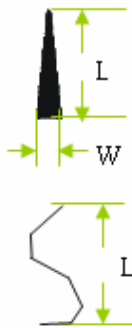
STANDARD DOC.	PRODUCT SPEC.	MODULE NO.			PAGE	20	
5	Line defect	 <p>L: length W: width</p>	Length	Width	Acceptable QTY		2.50
					A/B Area	C Area	
			≠	$W \leq 0.02$	No check	No check	
			$L \leq 3$	$W \leq 0.03$	2		
			$L \leq 2.5$	$0.03 < W \leq 0.05$	2	Sa round type	
	$W > 0.05$						

18.USING LCD MODULES

18-1 LIQUID CRYSTAL DISPLAY MODULES

LCD is composed of glass and polarizer. Pay attention to the following items when handling.

- (1) Please keep the temperature within specified range for use and storage. Polarization degradation, bubble generation or polarizer peel-off may occur with high temperature and high humidity.
- (2) Do not touch, push or rub the exposed polarizers with anything harder than an HB pencil lead (glass, tweezers, etc.).
- (3) N-hexane is recommended for cleaning the adhesives used to attach front/rear polarizers and reflectors made of organic substances which will be damaged by chemicals such as acetone, toluene, ethanol and isopropylalcohol.
- (4) If the display surface becomes contaminated, breathe on the surface and gently wipe it with a soft dry cloth. If it is heavily contaminated, wipe gently with absorbent cotton or other soft material like chamois soaked in Isopropyl alcohol or Ethyl alcohol. Do not scrub hard to avoid damaging the display surface.
- (5) Wipe off saliva or water drops immediately, contact with water over a long period of time may cause deformation or color fading.
- (6) Avoid contacting oil and fats.
- (7) Condensation on the surface and contact with terminals due to cold will damage, stain or dirty the polarizers. After products are tested at low temperature they must be warmed up in a container before coming is contacting with room temperature air.
- (8) Do not put or attach anything on the display area to avoid leaving marks on.
- (9) Do not touch the display with bare hands. This will stain the display area and degradate insulation between terminals (some cosmetics are determinated to the polarizers).
- (10) Exercise care to minimize corrosion of the electrode. Corrosion of the electrodes is accelerated by water droplets, moisture condensation or a current flow in a high-humidity environment.
- (11) As glass is fragile. It tends to become or chipped during handling especially on the edges. Please avoid dropping or jarring.

18-2 PRECAUTION FOR HANDING LCD MODULES

Since LCM has been assembled and adjusted with a high degree of precision, avoid applying excessive shocks to the module or making any alterations or modifications to it.

STANDARD DOC.	PRODUCT SPEC.	MODULE NO.		PAGE	21
<p>(1) Do not alter, modify or change the the shape of the tab on the metal frame.</p> <p>(2) Do not make extra holes on the printed circuit board, modify its shape or change the positions of components to be attached.</p> <p>(3) Do not damage or modify the pattern writing on the printed circuit board.</p> <p>(4) Absolutely do not modify the zebra rubber strip (conductive rubber) or heat seal connector.</p> <p>(5) Except for soldering the interface, do not make any alterations or modifications with a soldering iron.</p> <p>(6) Do not drop, bend or twist LCM. In particular, do not forcibly pull or bend the I/O cable or the backlight cable.</p> <p>(7) In order to avoid the cracking of the FPC,you should to pay attention to the area of FPC where the FPC was bent .the edge of coverlay;the area of surface of Ni-Au plating,the area of soldering land,the area of through hole.</p>					
<p>18-3 ELECTRO-STATIC DISCHARGE CONTROL</p>					
<p>Since this module uses a CMOS LSI, the same careful attention should be paid to electrostatic discharge as for an ordinary CMOS IC.</p>					
<p>(1) Make certain that you are grounded when handing LCM. To minimize the performance degradation of the LCD modules resulting from destruction caused by static electricity etc., exercise care to avoid holding the following sections when handling the modules. - Exposed area of the printed circuit board. - Terminal electrode sections.</p> <p>(2) Before remove LCM from its packing case or incorporating it into a set, be sure the module and your body have the same electric potential.</p> <p>(3) When soldering the terminal of LCM, make certain the AC power source for the soldering iron does not leak.</p> <p>(4) When using an electric screwdriver to attach LCM, the screwdriver should be of ground potentiality to minimize as much as possible any transmission of electromagnetic waves produced sparks coming from the commutator of the motor.</p> <p>(5) As far as possible make the electric potential of your work clothes and that of the work bench the ground potential.</p> <p>(6) To reduce the generation of static electricity be careful that the air in the work is not too dried. A relative humidity of 50%-60% is recommended.</p>					
<p>18-4 PRECAUTIONS FOR OPERATION</p>					
<p>(1) Viewing angle varies with the change of liquid crystal driving voltage (VO). Adjust VO to show the best contrast.</p> <p>(2) Driving the LCD in the voltage above the limit shortens its life.</p> <p>(3) If the LCD modules have been operating for a long time showing the same display patterns, the display patterns may remain on the screen as ghost images and a slight contrast irregularity may also appear. A normal operating status can be regained by suspending use for some time. It should be noted that this phenomenon does not adversely affect performance reliability.</p> <p>(4) Response time is greatly delayed at temperature below the operating temperature range. However, this does not mean the LCD will be out of the order. It will recover when it returns to the specified temperature range.</p> <p>(5) If the display area is pushed hard during operation, the display will become abnormal. However, it will return to normal if it is turned off and then back on.</p> <p>(6) Condensation on terminals can cause an electrochemical reaction disrupting the terminal circuit. Therefore, it must be used under the relative condition of 40°C , 50% RH.</p> <p>(7) When turning the power on, input each signal after the positive/negative voltage becomes stable.</p>					

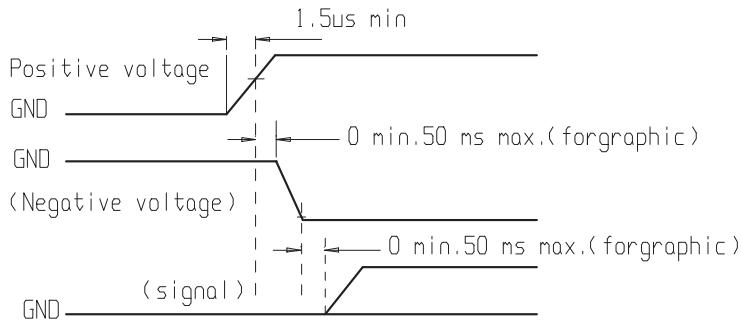

18-5 STORAGE

When storing LCDs as spares for some years, the following precaution are necessary.

- (1) Store them in a sealed polyethylene bag. If properly sealed, there is no need for dessicant.
- (2) Store them in a dark place. Do not expose to sunlight or fluorescent light, keep the temperature between 0°C and 35°C.
- 3) The polarizer surface should not come in contact with any other objects. (We advise you to store them in the container in which they were shipped.)
- (4) Environmental conditions :
 - Do not leave them for more than 160hrs. at 70°C.
 - Should not be left for more than 48hrs. at -20°C.

18-6 SAFETY

- (1) It is recommended to crush damaged or unnecessary LCDs into pieces and wash them off with solvents such as acetone and ethanol, which should later be burned.
- (2) If any liquid leakes out of a damaged glass cell and comes in contact with the hands, wash off thoroughly with soap and water.

18-7 LIMITED WARRANTY

Unless agreed between Newhaven and customer, Newhaven will replace or repair any of its LCD modules which are found to be functionally defective when inspected in accordance with Newhaven LCD acceptance standards (copies available upon request) for a period of one year from date of shipments. Cosmetic/visual defects must be returned to Newhaven within 90 days of shipment. Confirmation of such date shall be based on freight documents. The warranty liability of Newhaven limited to repair and/or replacement on the terms set forth above. Newhaven will not be responsible for any subsequent or consequential events.

18-8 RETURN LCM UNDER WARRANTY

No warranty can be granted if the precautions stated above have been disregarded. The typical examples of violations are :

- Broken LCD glass.
- Circuit modified in any way, including addition of components.

Module repairs will be invoiced to the customer upon mutual agreement. Modules must be returned with sufficient description of the failures or defects. Any connectors or cable installed by the customer must be removed completely without damaging the PCB's eyelet, conductors and terminals.