

Aluminum Capacitors Solid Axial

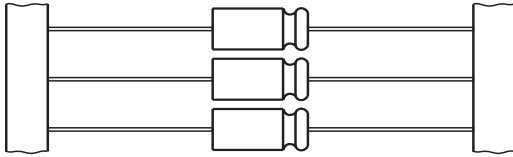
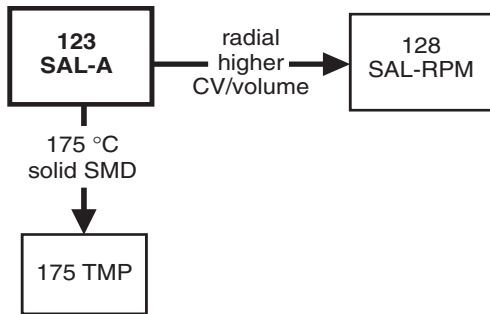

Fig.1 Component outline



FEATURES

- Polarized aluminum electrolytic capacitors, solid electrolyte MnO_2
- Axial leads, aluminum case, ceramic seal, blue insulation sleeve
- SAL-A: standard version
- SAL-AG: epoxy filled shock-proof version up to 10 000 g
- Extremely long useful life: 20 000 hours at 125 °C
- Extended high temperature range up to 200 °C
- Excellent low temperature impedance and ESR behaviour
- Charge and discharge proof, application with 0 Ω resistance allowed
- Reverse DC voltage up to 0.3 x U_R allowed
- AC voltage up to 0.8 x U_R allowed
- Advanced technology to achieve high reliability and high stability

RoHS*
COMPLIANT

QUICK REFERENCE DATA

DESCRIPTION	VALUE
Maximum case size (\varnothing D x L in mm)	6.7 x 15.3 to 12.9 x 32.0
Rated capacitance range (E6 series), C_R	1.0 μ F to 1500 μ F
Tolerance on C_R	± 20 %; ± 10 % on request
Rated voltage range, U_R	6.3 V to 40 V
Category temperature range	- 55 °C to + 125 °C
Usable temperature range	- 80 °C to + 200 °C
Endurance test at 155 °C and 125 °C	5000 hours and 8000 hours
Useful life at 125 °C	20 000 hours
Useful life at 40 °C, I_R applied	450 000 hours
Shelf life at 0 V, 125 °C	500 hours
Based on sectional specification	IEC 60384-4/EN130300
Climatic category IEC 60068	55/125/56

APPLICATIONS

- EDP, telecommunication, industrial high temperature, automotive, military and space
- Smoothing, filtering, buffering, timing
- For power supplies, DC/DC converters

MARKING

The capacitors are marked (where possible) with the following information:

- Rated capacitance (in μ F)
- Tolerance code on rated capacitance, code letter in accordance with IEC 60062 (M = ± 20 %, K = ± 10 %)
- Rated voltage (in V) at corresponding maximum temperature
- Date code in accordance with IEC 60062
- Name of manufacturer
- Code for factory of origin
- Band to indicate the negative terminal
- '+' sign to identify the positive terminal
- Series number

* Pb containing terminations are not RoHS compliant, exemptions may apply

SELECTION CHART FOR C_R, U_R AND RELEVANT MAXIMUM CASE SIZES ($\varnothing D \times L$ in mm)						
C_R (μF)	U_R (V) at $T_{amb} = 85^\circ C$					
	6.3	10	16	25	35	40
	U_C (V) at $T_{amb} = 125^\circ C$					
	6.3	10	16	25	25	25
1.0	-	-	-	-	6.7 x 15.3	-
1.5	-	-	-	-	6.7 x 15.3	-
2.2	-	-	-	-	6.7 x 15.3	6.7 x 15.3
3.3	-	-	-	-	6.7 x 15.3	6.7 x 15.3
4.7	-	-	-	-	6.7 x 15.3	6.7 x 15.3
6.8	-	-	-	-	6.7 x 15.3	6.7 x 15.3
10	-	-	6.7 x 15.3	6.7 x 15.3	7.6 x 20.4	7.6 x 20.4
15	-	-	6.7 x 15.3	6.7 x 15.3	7.6 x 20.4	7.6 x 20.4
22	-	-	6.7 x 15.3	7.6 x 20.4	7.6 x 20.4	9.4 x 23.3
33	-	6.7 x 15.3	7.6 x 20.4	7.6 x 20.4	9.4 x 23.3	9.4 x 23.3
47	6.7 x 15.3	6.7 x 15.3	7.6 x 20.4	7.6 x 20.4	9.4 x 23.3	10.3 x 32.0
68	6.7 x 15.3	7.6 x 20.4	7.6 x 20.4	9.4 x 23.3	10.3 x 32.0	10.3 x 32.0
100	-	7.6 x 20.4	9.4 x 23.3	9.4 x 23.3	12.9 x 32.0	12.9 x 32.0
150	7.6 x 20.4	9.4 x 23.3	9.4 x 23.3	10.3 x 32.0	12.9 x 32.0	-
220	-	9.4 x 23.3	10.3 x 32.0	12.9 x 32.0	-	-
330	9.4 x 23.3	10.3 x 32.0	10.3 x 32.0	12.9 x 32.0	-	-
470	-	10.3 x 32.0	12.9 x 32.0	-	-	-
680	10.3 x 32.0	12.9 x 32.0	12.9 x 32.0	-	-	-
1000	12.9 x 32.0	12.9 x 32.0	-	-	-	-
1500	12.9 x 32.0	-	-	-	-	-

DIMENSIONS in millimeters AND AVAILABLE FORMS

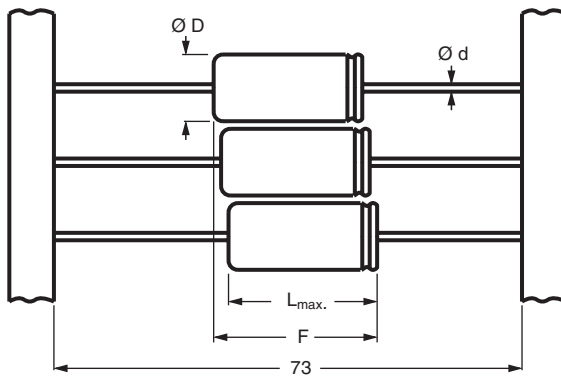

BA: taped in box (ammopack)
BR: taped on reel

Fig.2 Forms: BA and BR

Table 1

DIMENSIONS in millimeters, MASS AND PACKAGING QUANTITIES						
CASE		$F_{max.}$	$\varnothing d$	MASS ⁽²⁾ (g)	PACKAGING QUANTITIES	
MAXIMUM SIZE $\varnothing D \times L$ ⁽¹⁾	CODE				FORM BA	FORM BR
6.7 x 15.3	1	20.0	0.6	≈ 1.05	100	800
7.6 x 20.4	2A	22.5	0.6	≈ 1.55	100	800
9.4 x 23.3	4	25.0	0.6	≈ 2.6	100	500
10.3 x 32.0	5	35.0	0.8	≈ 4.2	100	500
12.9 x 32.0	6	35.0	0.8	≈ 7	100	400

Note

For epoxy-filled versions add 1 mm to stated $L_{max.}$
Add 10 % for SAL-AG epoxy-filled versions.
Detailed tape dimensions see section 'PACKAGING'.



ELECTRICAL DATA	
SYMBOL	DESCRIPTION
C _R	rated capacitance at 100 Hz
I _R	max. RMS ripple current, no necessary DC voltage applied
I _{L5}	max. leakage current after 5 minutes at U _R
tan δ	max. dissipation factor at 100 Hz
ESR	max./typ. equivalent series resistance at 100 Hz
Z	max. impedance at 100 kHz

Note

Unless otherwise specified, all electrical values in Table 2 apply at T_{amb} = 20 to 25 °C, P = 86 to 106 kPa, RH = 45 to 75 %.

ORDERING EXAMPLE

Electrolytic capacitors 123 series

10 µF/16 V; ± 20 %

Maximum case size: Ø 6.7 x 15.3 mm; Form BR

for lead (Pb)-free:

Ordering code: MAL212325109E3

Former 12NC: 2281 12325109

for non lead (Pb)-free:

Ordering code: MAL212325109

Former 12NC: 2222 12325109

Table 2

ELECTRICAL DATA AND ORDERING INFORMATION for 123 series															
U _C (V)	U _R (V)	C _R 100 Hz (µF)	MAX. CASE SIZE Ø D x L (mm)	I _R 100 Hz 125 °C (mA)	I _R 10 kHz 85 °C (mA)	I _R 100 kHz 40 °C (mA)	I _{L5} 5 min (µA)	tan δ 100 Hz	MAX. ESR 100 Hz (Ω)	TYP. ESR 100 Hz (Ω)	Z 100 kHz (Ω)	ORDERING CODE			
												SAL-A FORM BA tol. ± 20 %	SAL-A FORM BR tol. ± 20 %	SAL- AG ⁽¹⁾ FORM BA tol. ± 10 % level S	SAL- AG ⁽¹⁾ FORM BA tol. ± 20 %
6.3	6.3	47	6.7 x 15.3	58	440	640	15	0.18	7.6	3.0	1.2	13479	23479	83479	63479
		68	6.7 x 15.3	83	520	760	21	0.18	5.3	2.6	1.2	13689	23689	83689	63689
		150	7.6 x 20.4	160	870	1270	47	0.18	2.4	1.5	1.0	13151	23151	83151	63151
		330	9.4 x 23.3	330	1470	2140	104	0.18	1.1	0.55	0.4	13331	23331	83331	63331
		680	10.3 x 32.0	680	2340	3410	214	0.18	0.55	0.28	0.3	13681	23681	83681	63681
		1000	12.9 x 32.0	940	3180	4640	315	0.18	0.36	0.19	0.2	13102	23102	83102	63102
		1500	12.9 x 32.0	1220	4140	6020	473	0.18	0.24	0.13	0.2	13152	23152	83152	63152
10	10	33	6.7 x 15.3	63	360	530	17	0.18	11	3.8	1.2	14339	24339	84339	64339
		47	6.7 x 15.3	83	440	640	24	0.18	7.6	4.0	1.2	14479	24479	84479	64479
		68	7.6 x 20.4	110	590	850	34	0.18	5.3	2.5	1.0	14689	24689	84689	64689
		100	7.6 x 20.4	160	710	1040	50	0.18	3.6	1.8	1.0	14101	24101	84101	64101
		150	9.4 x 23.3	240	990	1450	75	0.18	2.4	0.9	0.4	14151	24151	84151	64151
		220	9.4 x 23.3	350	1180	1720	110	0.18	1.7	0.6	0.4	14221	24221	84221	64221
		330	10.3 x 32.0	490	1650	2410	165	0.18	1.1	0.45	0.3	14331	24331	84331	64331
		470	10.3 x 32.0	570	1940	2830	235	0.18	0.8	0.35	0.3	14471	24471	84471	64471
		680	12.9 x 32.0	760	2580	3750	340	0.18	0.55	0.25	0.2	14681	24681	84681	64681
		1000	12.9 x 32.0	1000	3380	4920	500	0.18	0.36	0.18	0.2	14102	24102	84102	64102
16	16	10	6.7 x 15.3	31	230	330	16	0.14	28	8.0	2.5	15109	25109	85109	65109
		15	6.7 x 15.3	47	280	400	24	0.14	19	5.5	2.5	15159	25159	85159	65159
		22	6.7 x 15.3	63	340	490	35	0.14	13	5.5	2.5	15229	25229	85229	65229
		33	7.6 x 20.4	89	470	680	55	0.14	8.4	3.0	2.0	15339	25339	85339	65339
		47	7.6 x 20.4	120	560	810	75	0.14	5.9	2.6	2.0	15479	25479	85479	65479
		68	7.6 x 20.4	180	670	970	110	0.14	4.1	2.5	2.0	15689	25689	85689	65689
		100	9.4 x 23.3	260	920	1340	160	0.14	2.8	1.5	0.8	15101	25101	85101	65101
		150	9.4 x 23.3	310	1060	1550	240	0.16	2.1	0.7	0.8	15151	25151	85151	65151
		220	10.3 x 32.0	420	1420	2060	350	0.16	1.5	0.55	0.6	15221	25221	85221	65221
		330	10.3 x 32.0	510	1740	2530	500	0.16	1.0	0.35	0.6	15331	25331	85331	65331
		470	12.9 x 32.0	680	2280	3330	750	0.16	0.7	0.25	0.4	15471	25471	85471	65471
680	12.9 x 32.0	850	2870	4170	870	0.16	0.5	0.18	0.4	15681	25681	85681	65681		
25	25	10	6.7 x 15.3	43	230	330	25	0.14	28	13.0	5	16109	26109	86109	66109
		15	6.7 x 15.3	60	280	400	35	0.14	19	10.0	5.0	16159	26159	86159	66159
		22	7.6 x 20.4	88	370	550	55	0.14	13	7	2.5	16229	26229	86229	66229
		33	7.6 x 20.4	130	470	680	85	0.14	8.4	5	2.5	16339	26339	86339	66339
		47	7.6 x 20.4	160	560	810	100	0.14	5.9	3.5	2.5	16479	26479	86479	66479
		68	9.4 x 23.3	230	760	1110	170	0.14	4.1	1.8	1.0	16689	26689	86689	66689
		100	9.4 x 23.3	250	860	1250	250	0.16	3.2	1.0	1.0	16101	26101	86101	66101
		150	10.3 x 32.0	350	1200	1740	400	0.16	2.1	1.2	0.8	16151	26151	86151	66151
		220	12.9 x 32.0	460	1560	2270	550	0.16	1.5	0.85	0.6	16221	26221	86221	66221
		330	12.9 x 32.0	600	2030	2950	800	0.16	1.0	0.60	0.6	16331	26331	86331	66331



ELECTRICAL DATA AND ORDERING INFORMATION for 123 series															
U _C (V)	U _R (V)	C _R 100 Hz (μF)	MAX. CASE SIZE Ø D x L (mm)	I _R 100 Hz 125 °C (mA)	I _R 10 kHz 85 °C (mA)	I _R 100 kHz 40 °C (mA)	I _{L5} 5 min (μA)	tan δ 100 Hz	MAX. ESR 100 Hz (Ω)	TYP. ESR 100 Hz (Ω)	Z 100 kHz (Ω)	ORDERING CODE			
												MAL2123.....E3 Lead (Pb)-free MAL2123 Non lead (Pb)-free			
												SAL-A FORM BA tol. ± 20 %	SAL-A FORM BR tol. ± 20 %	SAL- AG ⁽¹⁾ FORM BA tol. ± 10 % level S	SAL- AG ⁽¹⁾ FORM BA tol. ± 20 %
25	35	1.0	6.7 x 15.3	4	55	80	5	0.12	240	105	16.5	10108	20108	80108	60108
		1.5	6.7 x 15.3	7	68	98	5	0.12	160	40.60	11.0	10158	20158	80158	60158
		2.2	6.7 x 15.3	10	82	120	5	0.12	109	30	7.5	10228	20228	80228	60228
		3.3	6.7 x 15.3	14	100	150	7	0.12	73	28	7.5	10338	20338	80338	60338
		4.7	6.7 x 15.3	20	120	170	10	0.12	51	20	7.5	10478	20478	80478	60478
		6.8	6.7 x 15.3	27	140	210	15	0.12	35	16	7.5	10688	20688	80688	60688
		10	7.6 x 20.4	37	200	280	20	0.12	24	10	2.5	10109	20109	80109	60109
		15	7.6 x 20.4	53	240	350	30	0.12	16	8	2.5	10159	20159	80159	60159
		22	7.6 x 20.4	78	290	420	45	0.12	11	7	2.5	10229	20229	80229	60229
		33	9.4 x 23.3	120	410	590	65	0.12	7.2	3	1.0	10339	20339	80339	60339
		47	9.4 x 23.3	140	480	700	95	0.12	5.1	2.9	1.0	10479	20479	80479	60479
		68	10.3 x 32.0	170	570	820	135	0.16	4.7	2.1	0.8	10689	20689	80689	60689
		100	12.9 x 32.0	220	760	1100	200	0.16	3.2	1.7	0.6	10101	20101	80101	60101
		150	12.9 x 32.0	290	990	1440	300	0.16	2.1	1.0	0.6	10151	20151	80151	60151
		25	40	2.2	6.7 x 15.3	11	82	120	9	0.12	109	38	7.5	17228	27228
3.3	6.7 x 15.3			16	100	150	13	0.12	73	25	7.5	17338	27338	87338	67338
4.7	6.7 x 15.3			22	120	170	19	0.12	51	20	7.5	17478	27478	87478	67478
6.8	6.7 x 15.3			28	140	210	27	0.12	35	15	7.5	17688	27688	87688	67688
10	7.6 x 20.4			41	200	280	40	0.12	24	11	2.5	17109	27109	87109	67109
15	7.6 x 20.4			61	240	350	60	0.12	16	7	2.5	17159	27159	87159	67159
22	9.4 x 23.3			89	330	480	90	0.12	11	4	1.5	17229	27229	87229	67229
33	9.4 x 23.3			120	410	590	130	0.12	7.2	2.9	1.0	17339	27339	87339	67339
47	10.3 x 32.0			160	540	790	190	0.12	5.1	2.7	1.0	17479	27479	87479	67479
68	10.3 x 32.0			170	570	820	270	0.16	4.7	2.3	0.8	17689	27689	87689	67689
100	12.9 x 32.0	220	760	1100	400	0.16	3.2	1.6	0.6	17101	27101	87101	67101		

Note
SAL-AG types are epoxy-filled.

ADDITIONAL ELECTRICAL DATA		
PARAMETER	CONDITIONS	VALUE
Voltage		
Surge voltage		$U_s \leq 1.15 \times U_R$
Reverse voltage		$U_{rev} < 0.3 \times U_R$
Maximum peak AC voltage, reverse voltage applied		$\leq 2 \text{ V}$
Maximum peak AC voltage, without reverse voltage applied	$T_{amb} \leq 85 \text{ °C}$: at $f \leq 0.1 \text{ Hz}$ at $0.1 \text{ Hz} < f \leq 1 \text{ Hz}$ at $1 \text{ Hz} < f \leq 10 \text{ Hz}$ at $10 \text{ Hz} < f \leq 50 \text{ Hz}$ at $f > 50 \text{ Hz}$ $85 \text{ °C} < T_{amb} \leq 125 \text{ °C}$: at $f \leq 0.1 \text{ Hz}$ at $0.1 \text{ Hz} < f \leq 1 \text{ Hz}$ at $1 \text{ Hz} < f \leq 10 \text{ Hz}$ at $10 \text{ Hz} < f \leq 50 \text{ Hz}$ at $f > 50 \text{ Hz}$	$0.30 \times U_R$ $0.45 \times U_R$ $0.60 \times U_R$ $0.65 \times U_R$ $0.80 \times U_R$ $0.15 \times U_R$ $0.22 \times U_R$ $0.30 \times U_R$ $0.32 \times U_R$ $0.40 \times U_R$
Current		
Maximum leakage current	After 5 minutes at U_R and $T_{amb} = 25 \text{ °C}$	$I_{L5} \leq 0.05 C_R \times U_R$ or 2 μA , whichever is greater; see Table 2
Typical leakage current	After 15 s at U_R and $T_{amb} = 25 \text{ °C}$: $U_R = 6.3$ to 16 V $U_R = 25$ to 40 V	$\approx 0.2 \times$ value stated in Table 2 $\approx 0.1 \times$ value stated in Table 2

VOLTAGE

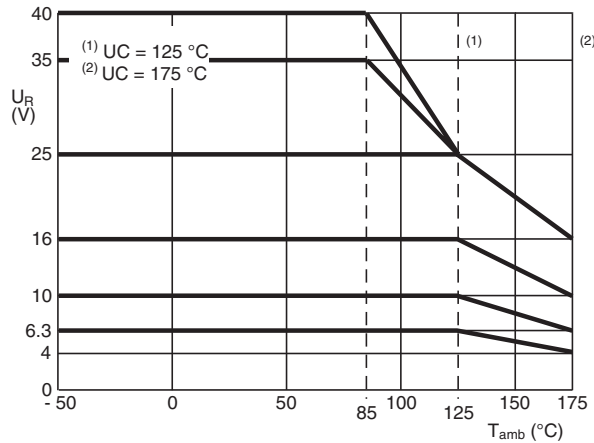

Fig.3 Maximum permissible voltage up to 175 °C

RIPPLE CURRENT (I_R)						
PARAMETER	T_{amb}					
	25 °C	40 °C	65 °C	85 °C	105 °C	125 °C
I_R multiplier	1.1	1.0	0.88	0.75	0.59	0.37

Notes

- (1) Applying the maximum RMS ripple current given in Table 2 will cause a device temperature of 138 °C.
- (2) The 100 kHz values in Table 2 for other temperatures are to be calculated with the above I_R multipliers.

LEAKAGE CURRENT

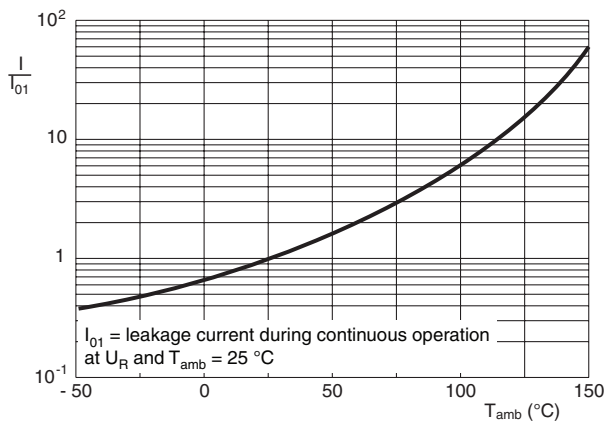

Fig.4 Typical multiplier of leakage current as a function of ambient temperature

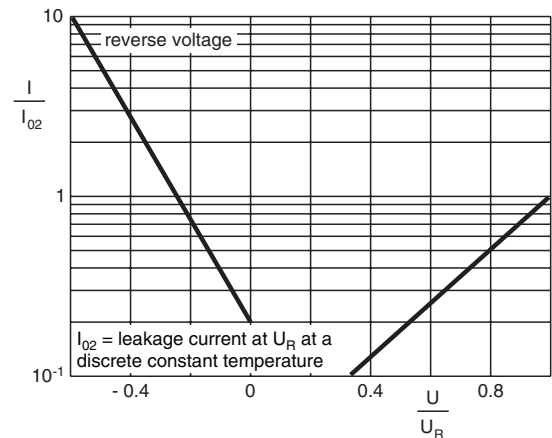

Fig.5 Typical multiplier of leakage current as a function of U/UR

CAPACITANCE (C)

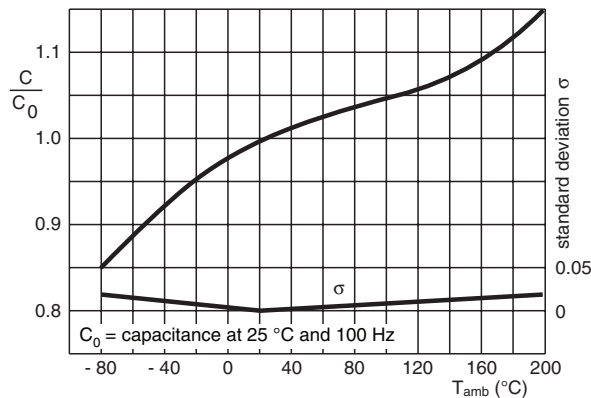

Fig.6 Typical multiplier of capacitance as a function of ambient temperature

DISSIPATION FACTOR (tan δ)

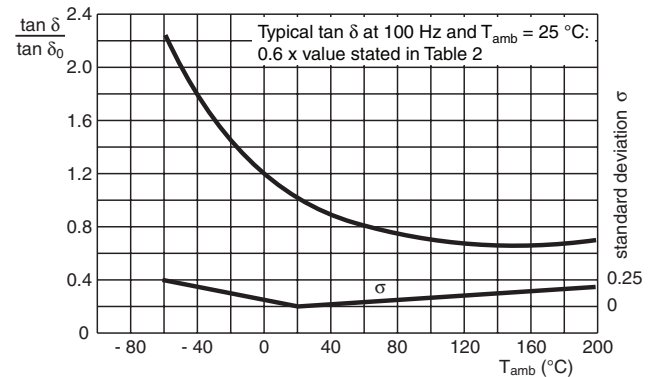

Fig.7 Typical multiplier of dissipation factor as a function of ambient temperature



MAXIMUM POWER DISSIPATION	
MAXIMUM CASE SIZE Ø D x L (mm)	$P_{max.} = P_{125}$ (W)
6.7 x 15.3	0.13
7.6 x 20.4	0.16
9.4 x 23.3	0.21
10.3 x 32.0	0.26
12.9 x 32.0	0.32

EQUIVALENT SERIES INDUCTANCE (ESL), f = 10 MHz			
MAXIMUM CASE SIZE Ø D x L (mm)	PITCH (mm)	MAX. ESL (nH)	TYP. ESL (nH)
6.7 x 15.3	20.3	30	15 to 23
7.6 x 20.4	25.4	30	16 to 24
9.4 x 23.3	27.9	35	20 to 27
10.3 x 32.0	35.6	40	26 to 33
12.9 x 32.0	35.6	55	32 to 49

IMPEDANCE (Z)

Typical impedance at 100 kHz and $T_{amb} = 25\text{ }^{\circ}\text{C}$: 0.5 x value stated in Table 2.

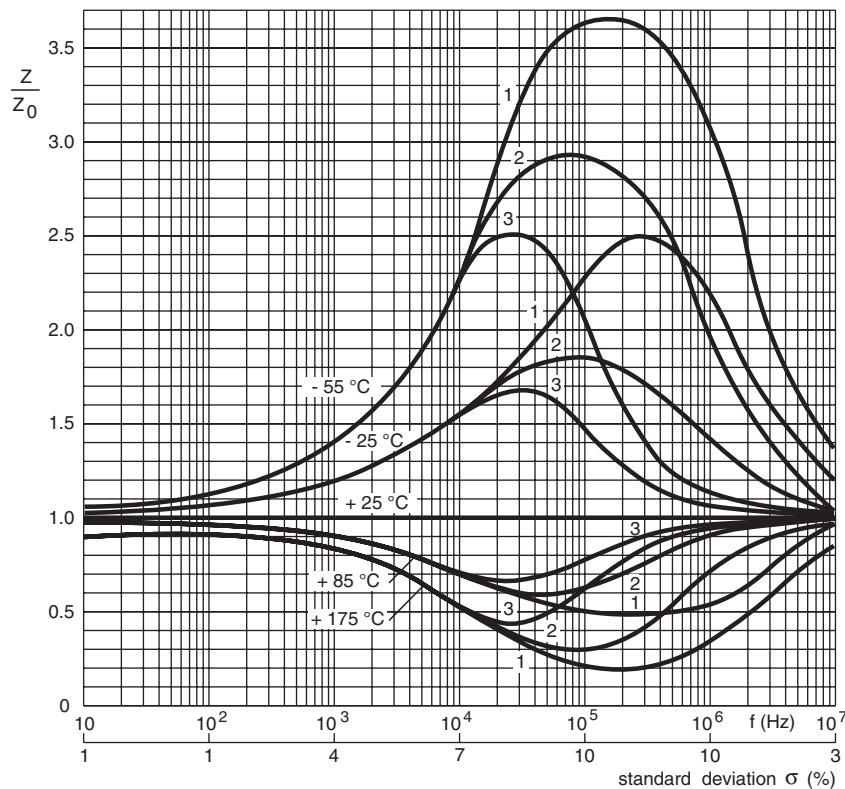

Curve 1: case Ø D x L = 6.7 x 15.3 and 7.6 x 20.4 mm; 16 to 40 V
 Curve 2: case Ø D x L = 6.7 x 15.3 and 7.6 x 20.4 mm; 6.3 to 10 V
 Curve 3: case Ø D x L = 9.4 x 32.0, 10.3 x 32.0 and 12.9 x 32.0 mm
 Z_0 = initial impedance value at any frequency and $T_{amb} = 25\text{ }^{\circ}\text{C}$

Fig.9 Typical multiplier of impedance as a function of frequency at different ambient temperatures

IMPEDANCE (Z)

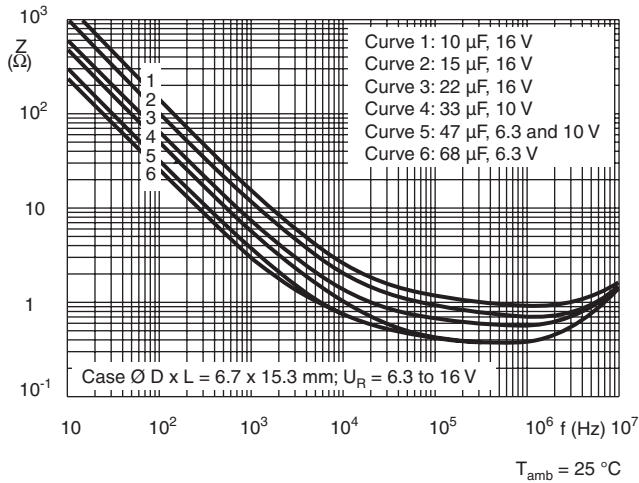

Fig.10 Typical impedance as a function of frequency

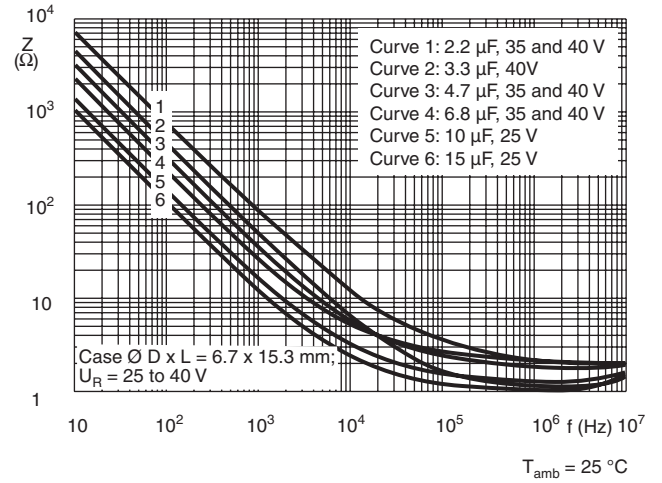

Fig.11 Typical impedance as a function of frequency

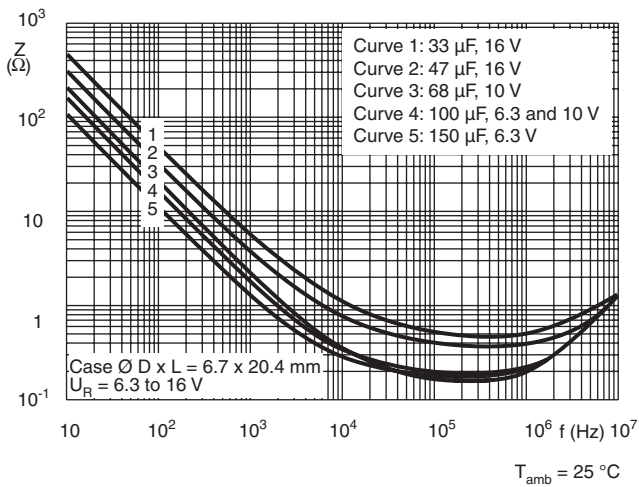

Fig.12 Typical impedance as a function of frequency

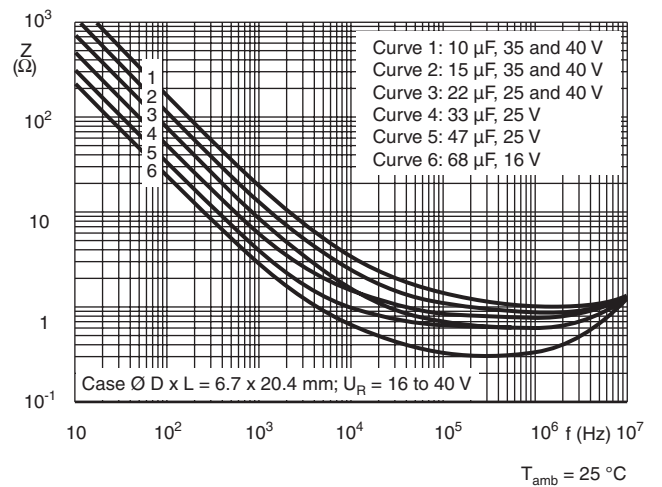

Fig.13 Typical impedance as a function of frequency

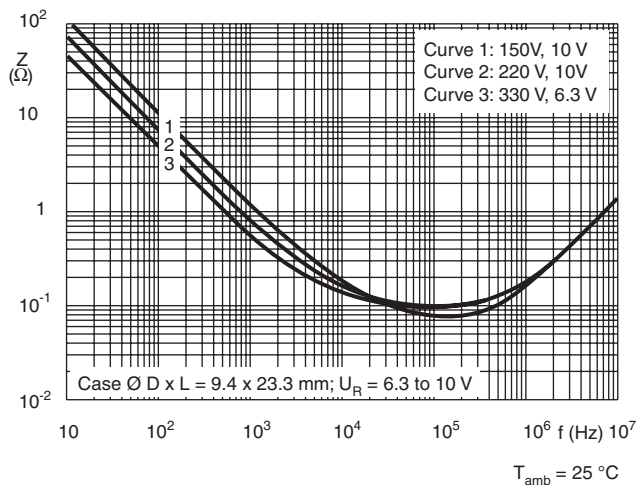

Fig.14 Typical impedance as a function of frequency

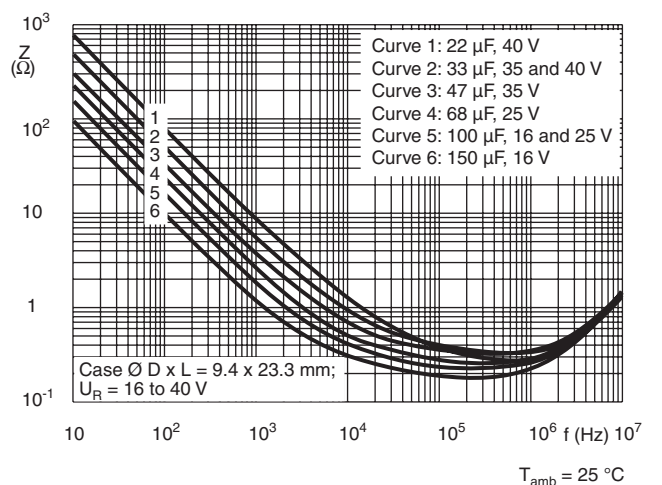

Fig.15 Typical impedance as a function of frequency



IMPEDANCE (Z)

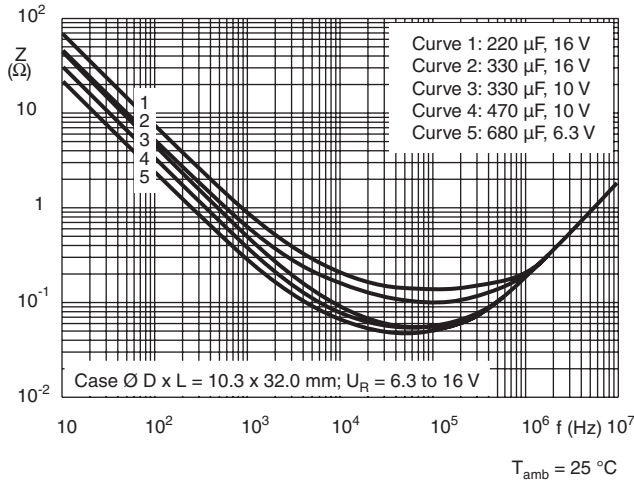

Fig.16 Typical impedance as a function of frequency

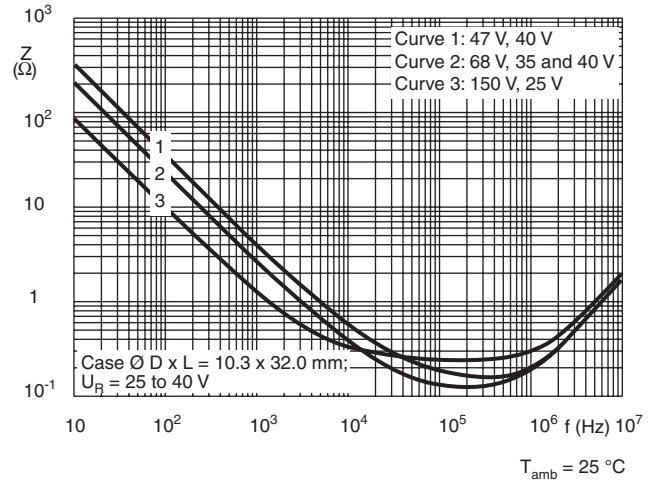

Fig.17 Typical impedance as a function of frequency

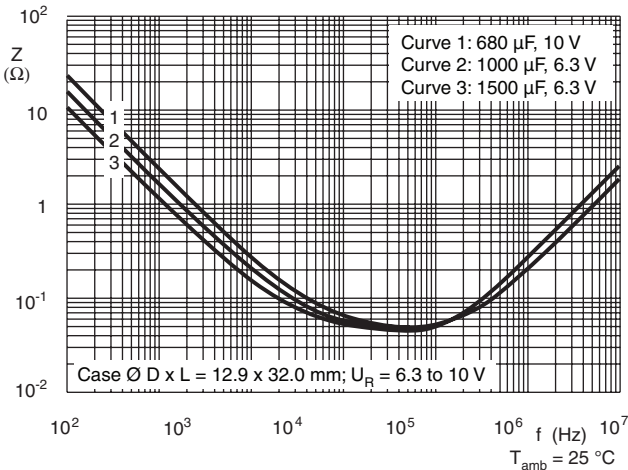

Fig.18 Typical impedance as a function of frequency

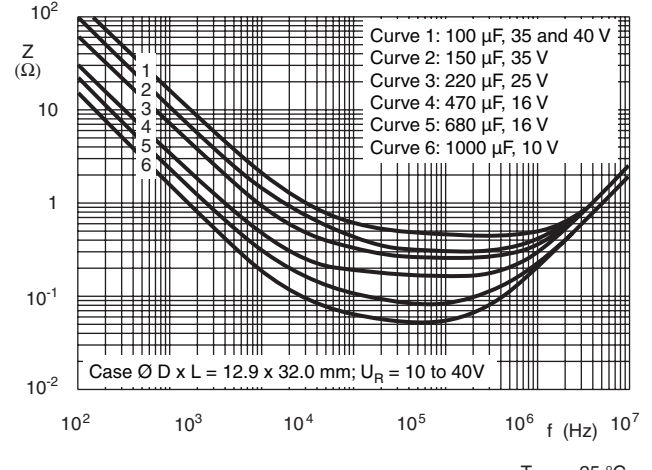

Fig.19 Typical impedance as a function of frequency

EQUIVALENT SERIES RESISTANCE (ESR)

Typical ESR: see Figs 20 to 24; the standard deviation is 20 % of each value.

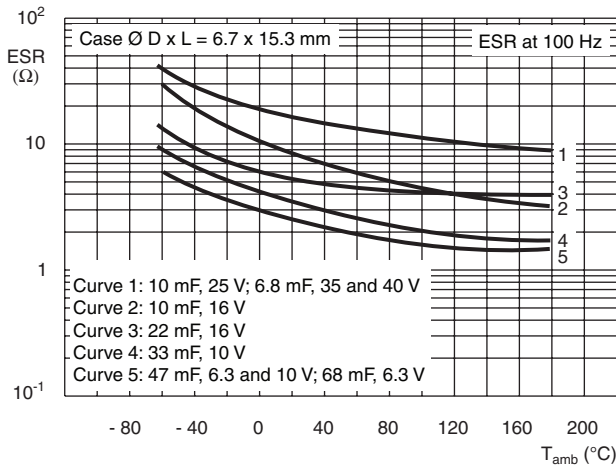

Fig.20 Typical ESR as a function of ambient temperature

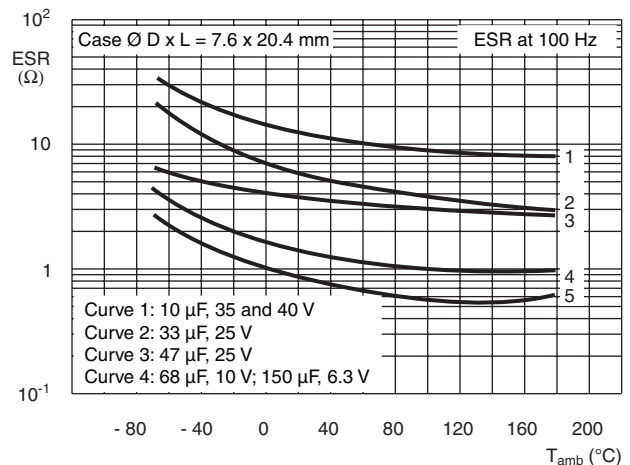

Fig.21 Typical ESR as a function of ambient temperature

EQUIVALENT SERIES RESISTANCE (ESR)

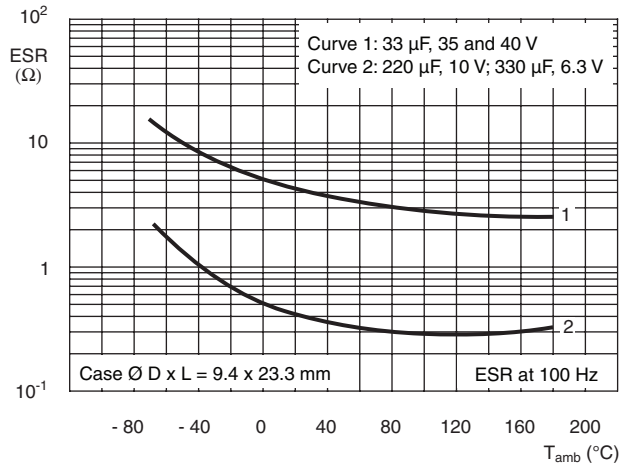

Fig.22 Typical ESR as a function of ambient temperature

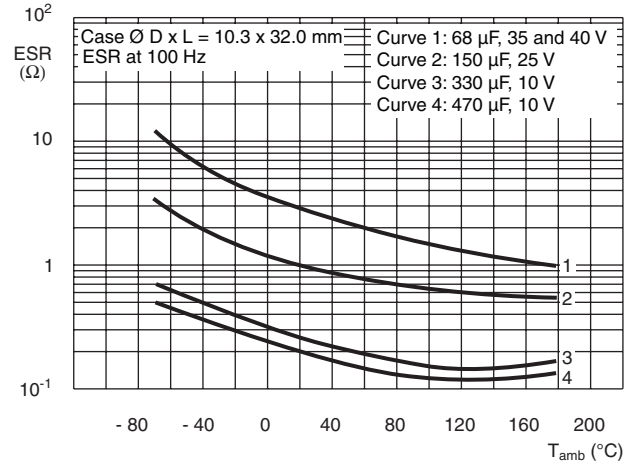

Fig.23 Typical ESR as a function of ambient temperature

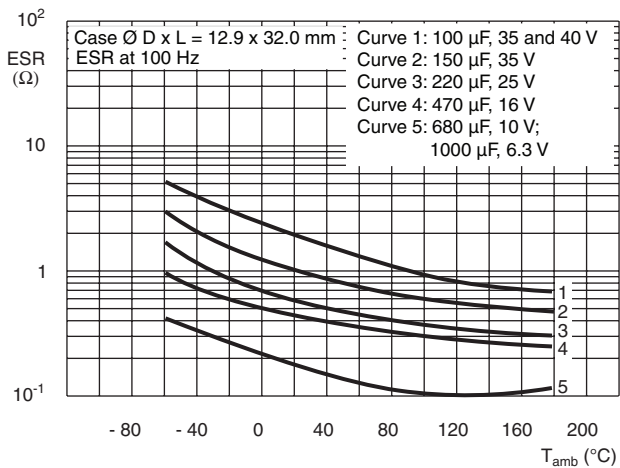

Fig.24 Typical ESR as a function of ambient temperature

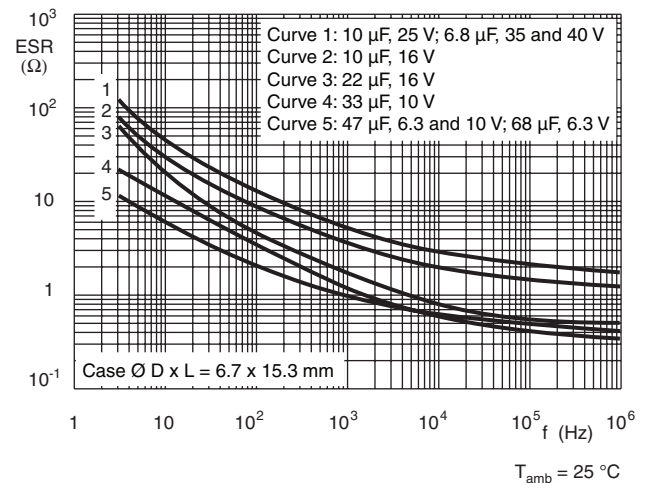

Fig.25 Typical ESR as a function of frequency

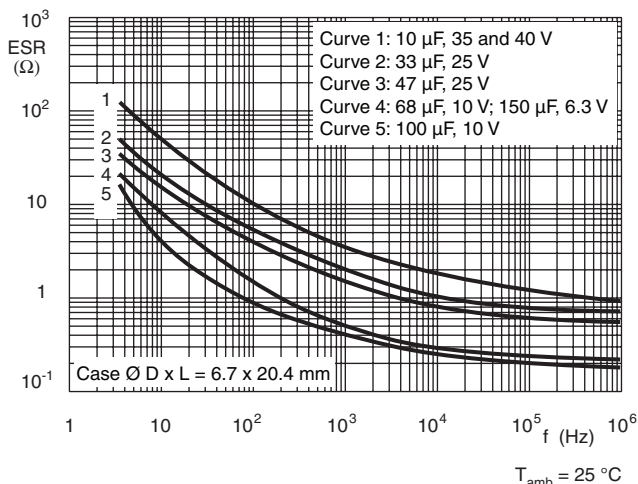

Fig.26 Typical ESR as a function of frequency

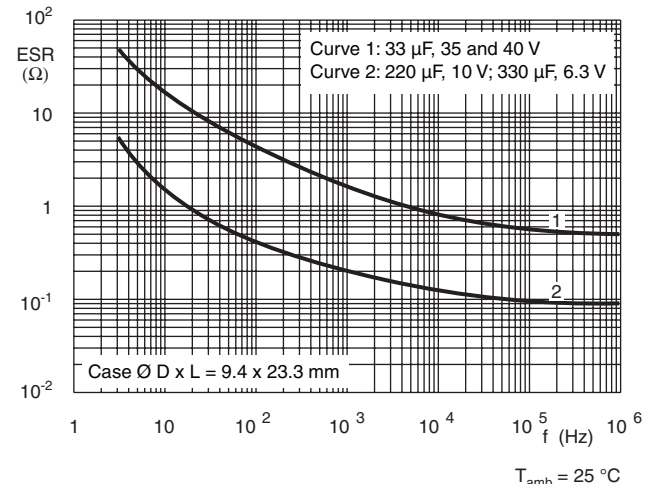

Fig.27 Typical ESR as a function of frequency

EQUIVALENT SERIES RESISTANCE (ESR)

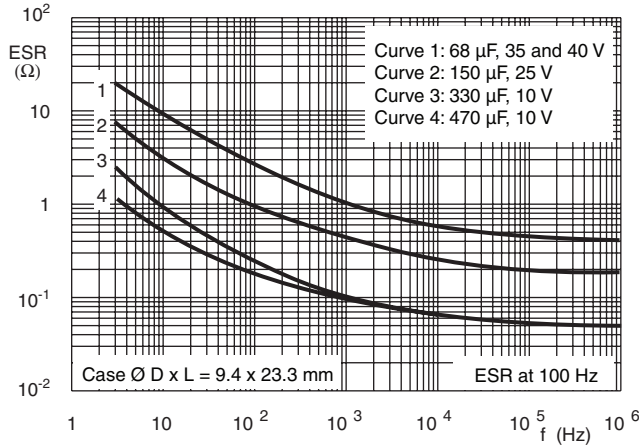

Fig.28 Typical ESR as a function of ambient temperature

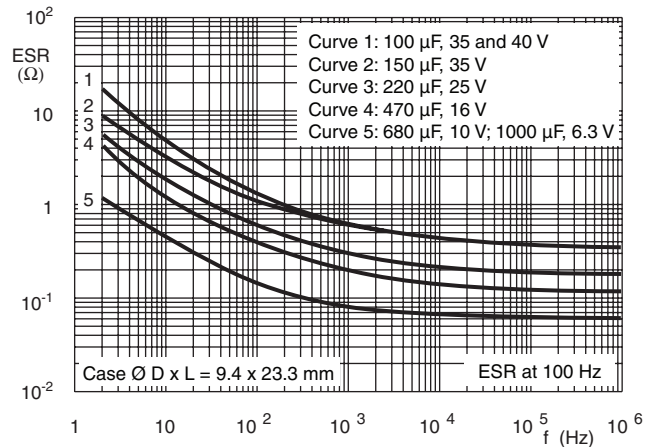

Fig.29 Typical ESR as a function of ambient temperature

Table 3

TEST PROCEDURES AND REQUIREMENTS			
TEST		PROCEDURE (quick reference)	REQUIREMENTS
NAME OF TEST	REFERENCE		
Endurance	IEC 60384-4/ EN130300 subclause 4.13	$T_{amb} = 125\text{ }^{\circ}\text{C}$; $U_R = 6.3$ to 25 V with U_R applied; $U_R = 35$ and 40 V with U_C applied; 10 000 hours	$\Delta C/C: \pm 10\%$ $\tan \delta \leq 1.2 \times \text{spec. limit}$ $Z \leq 1.2 \times \text{spec. limit}$ $I_{L5} \leq \text{spec. limit}$
Useful life	CECC 30302 subclause 1.8.1	$T_{amb} = 125\text{ }^{\circ}\text{C}$; I_R applied and $U_R = 6.3$ to 25 V with U_R applied; $U_R = 35$ and 40 V with U_C applied; 20 000 hours	$\Delta C/C: \pm 15\%$ $\tan \delta \leq 1.5 \times \text{spec. limit}$ $Z \leq 1.5 \times \text{spec. limit}$ $I_{L5} \leq \text{spec. limit}$ no short or open circuit, no visible damage total failure percentage: $< 1\%$
Shelf life (storage at high temperature)	IEC 60384-4/ EN130300 subclause 4.17	$T_{amb} = 125\text{ }^{\circ}\text{C}$; no voltage applied; 500 hours	$\Delta C/C: \pm 10\%$ $\tan \delta \leq 1.2 \times \text{spec. limit}$ $I_{L5} \leq 1 \times \text{spec. limit}$
Charge and discharge	IEC 60384-4-2 subclause 9.21	10^6 cycles without series resistance: 0.5 s to U_R ; 0.5 s to ground	$\Delta C/C: \pm 5\%$ no short or open circuit, no visible damage
Shock	IEC 60068-2-27 test Ea	half-sine or saw tooth pulse shape; 50 g; 11 ms; 3 successive shocks in each direction of 3 mutually perpendicular axes; no voltage applied	no intermittent contacts no breakdown no open circuiting no mechanical damage $\Delta C/C: \pm 5\%$ $\tan \delta \leq 1.2 \times \text{spec. limit}$ $Z \leq 1.2 \times \text{spec. limit}$ $I_{L5} \leq 1.5 \times \text{spec. limit}$
Severe rapid change of temperature		100 cycles of 1 hour duration, each with 30 minutes at $-40\text{ }^{\circ}\text{C}$ and $+125\text{ }^{\circ}\text{C}$	$\Delta C/C: \pm 25\%$ $\tan \delta \leq 1.5 \times \text{spec. limit}$ $Z \leq 2.0 \times \text{spec. limit}$ $I_{L5} \leq 1 \times \text{spec. limit}$
Solvent resistance	IEC 60068-2-45, test XA IEC 60653	immersion: 5 ± 0.5 minutes with or without ultrasonic at $55 \pm 5\text{ }^{\circ}\text{C}$ solvents: demineralized water and/or calgonite solution (20 g/l)	visual appearance not affected
Passive flammability	IEC 60695-2-2	capacitor mounted to a vertical printed-circuit board, one flame on capacitor body; $T_{amb} = 20$ to $25\text{ }^{\circ}\text{C}$; test duration = 20 s	after removing the test flame from the capacitor, the capacitor must not continue to burn for more than 15 s; no burning particles must drop from the sample



ADDITIONAL TESTS AND REQUIREMENTS FOR EPOXY-FILLED VERSIONS SAL-AG

2281 123 8.... Form BA ± 10 %, level S, lead (Pb)-free

2222 123 8.... Form BA ± 10 %, level S, non lead (Pb)-free

Table 4

TEST PROCEDURES AND REQUIREMENTS		
TEST	PROCEDURE	REQUIREMENTS
Severe vibration tests in accordance with "IEC 60068-2-6" and "MIL STD-202", method 204, letter E, with the following details and additions		
Method of mounting: severity 1 severity 2 severity 1 and 2	clamping both body and leads frequency range temperature 10 to 3000 Hz; 20 to 25 °C frequency range temperature 50 to 2000 Hz; 125 °C vibration amplitude: 50 g or 3.5 mm, whichever is less	$\Delta C/C: \pm 10 \%$ $\tan \delta \leq 1.2 \times \text{stated limit}$ $Z \leq 1.4 \times \text{stated limit}$ DC leakage current: \leq stated limit no intermittent contacts no indication of breakdown no open circuiting no evidence of mechanical damage
Direction and duration of motion: severity 1 severity 2	1 octave/minute; 3 directions (mutually perpendicular); 20 sweeps per direction (total 60 sweeps or 18 hours) 1 octave/minute; 2 directions (longitudinal and transversal); 3 sweeps per direction (total 6 sweeps or 1 hour)	
Functioning: severity 1 severity 2	rated voltage applied no voltage applied	
Typical capability	> 80 g at 10 to 3000 Hz (also at 125 °C)	
Severe shock tests in accordance with "IEC 60068-2-27" and "MIL STD-202", method 213, letter F, with the following details and additions:		
Method of mounting	clamping both body and leads	$\Delta C/C: \pm 10 \%$ $\tan \delta \leq 1.2 \times \text{stated limit}$ $Z \leq 1.4 \times \text{stated limit}$ DC leakage current: \leq stated limit no intermittent contacts no indication of breakdown no open circuiting no evidence of mechanical damage
Pulse shape: severity 1 severity 2 severity 3	half-sine or sawtooth 1500 g; 0.5 ms ("MIL STD-202", method 213, letter F) 3000 g; 0.2 ms 10 000 g; 0.1 ms	
Direction and number of shocks: severity 1 and 2 severity 3	3 successive shocks in each direction of 3 mutually perpendicular axes (total 18 shocks) 1 shock in any direction	
Functioning	rated voltage applied	



Disclaimer

All product specifications and data are subject to change without notice.

Vishay Intertechnology, Inc., its affiliates, agents, and employees, and all persons acting on its or their behalf (collectively, "Vishay"), disclaim any and all liability for any errors, inaccuracies or incompleteness contained herein or in any other disclosure relating to any product.

Vishay disclaims any and all liability arising out of the use or application of any product described herein or of any information provided herein to the maximum extent permitted by law. The product specifications do not expand or otherwise modify Vishay's terms and conditions of purchase, including but not limited to the warranty expressed therein, which apply to these products.

No license, express or implied, by estoppel or otherwise, to any intellectual property rights is granted by this document or by any conduct of Vishay.

The products shown herein are not designed for use in medical, life-saving, or life-sustaining applications unless otherwise expressly indicated. Customers using or selling Vishay products not expressly indicated for use in such applications do so entirely at their own risk and agree to fully indemnify Vishay for any damages arising or resulting from such use or sale. Please contact authorized Vishay personnel to obtain written terms and conditions regarding products designed for such applications.

Product names and markings noted herein may be trademarks of their respective owners.