

- Converts Light Intensity to Output Voltage
- Monolithic Silicon IC Containing Photodiode, Transconductance Amplifier, and Feedback Components
- Single-Supply Operation . . . 2.7 V to 5.5 V
- High Irradiance Responsivity . . . Typical 246 mV/( $\mu\text{W}/\text{cm}^2$ ) at  $\lambda_p = 640 \text{ nm}$  (TSL12S)
- Low Supply Current . . . 1.1 mA Typical
- Sidelooker 3-Lead Plastic Package
- RoHS Compliant (–LF Package Only)

PACKAGE S  
SIDELOOKER  
(FRONT VIEW)

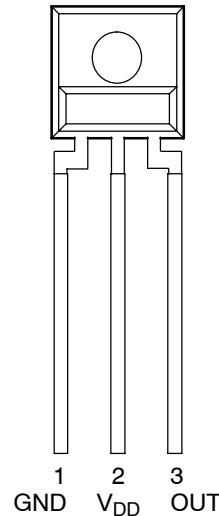

PACKAGE SM  
SURFACE MOUNT  
SIDELOOKER  
(FRONT VIEW)

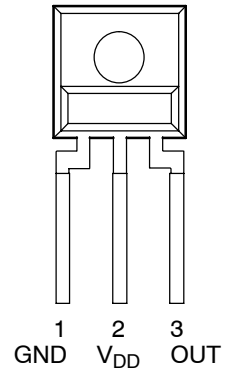

## Description

The TSL12S, TSL13S, and TSL14S are cost-optimized, highly integrated light-to-voltage optical sensors, each combining a photodiode and a transimpedance amplifier (feedback resistor = 80 M $\Omega$ , 20 M $\Omega$ , and 5 M $\Omega$ , respectively) on a single monolithic integrated circuit. The photodiode active area is 0.5 mm  $\times$  0.5 mm and the sensors respond to light in the range of 320 nm to 1050 nm. Output voltage is linear with light intensity (irradiance) incident on the sensor over a wide dynamic range. These devices are supplied in a 3-lead clear plastic sidelooker package (S). When supplied in the lead (Pb) free package, the device is RoHS compliant.

## Functional Block Diagram

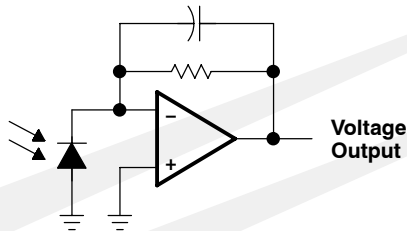

# TSL12S, TSL13S, TSL14S LIGHT-TO-VOLTAGE CONVERTERS

TAOS051E – SEPTEMBER 2007

## Available Options

| DEVICE | T <sub>A</sub> | PACKAGE – LEADS                                  | PACKAGE DESIGNATOR | ORDERING NUMBER |
|--------|----------------|--|--------------------|-----------------|
| TSL12S | 0°C to 70°C    | 3-lead Sidelooker                                | S                  | TSL12S          |
| TSL12S | 0°C to 70°C    | 3-lead Sidelooker — Lead (Pb) Free               | S                  | TSL12S-LF       |
| TSL12S | 0°C to 70°C    | 3-lead Surface-Mount Sidelooker — Lead (Pb) Free | SM                 | TSL12SM-LF      |
| TSL13S | 0°C to 70°C    | 3-lead Sidelooker                                | S                  | TSL13S          |
| TSL13S | 0°C to 70°C    | 3-lead Sidelooker — Lead (Pb) Free               | S                  | TSL13S-LF       |
| TSL13S | 0°C to 70°C    | 3-lead Surface-Mount Sidelooker — Lead (Pb) Free | SM                 | TSL13SM-LF      |
| TSL14S | 0°C to 70°C    | 3-lead Sidelooker                                | S                  | TSL14S          |
| TSL14S | 0°C to 70°C    | 3-lead Sidelooker — Lead (Pb) Free               | S                  | TSL14S-LF       |
| TSL14S | 0°C to 70°C    | 3-lead Surface-Mount Sidelooker — Lead (Pb) Free | SM                 | TSL14SM-LF      |

## Terminal Functions

| TERMINAL NAME   | NO. | TYPE | DESCRIPTION  |
|-----------------|-----|------|--|
| GND             | 1   |      | Power supply ground (substrate). All voltages are referenced to GND. |
| OUT             | 3   | O    | Output voltage.  |
| V <sub>DD</sub> | 2   |      | Supply voltage.  |

## Absolute Maximum Ratings over operating free-air temperature range (unless otherwise noted)<sup>†</sup>

|  |               |
|--|---------------|
| Supply voltage, V <sub>DD</sub> (see Note 1)                             | 6 V           |
| Output current, I <sub>O</sub>   | ±10 mA        |
| Duration of short-circuit current at (or below) 25°C (see Note 2)        | 5 s           |
| Operating free-air temperature range, T <sub>A</sub>                     | –25°C to 85°C |
| Storage temperature range, T <sub>stg</sub>                              | –25°C to 85°C |
| Lead temperature 1,6 mm (1/16 inch) from case for 10 seconds (S Package) | 260°C         |
| Reflow solder, in accordance with J-STD-020C or J-STD-020D (SM Package)  | 260°C         |

<sup>†</sup> Stresses beyond those listed under “absolute maximum ratings” may cause permanent damage to the device. These are stress ratings only, and functional operation of the device at these or any other conditions beyond those indicated under “recommended operating conditions” is not implied. Exposure to absolute-maximum-rated conditions for extended periods may affect device reliability.

- NOTES: 1. All voltages are with respect to GND.  
2. Output may be shorted to supply.

## Recommended Operating Conditions

|  | MIN | NOM | MAX | UNIT |
|--|-----|-----|-----|------|
| Supply voltage, V <sub>DD</sub>                | 2.7 |     | 5.5 | V    |
| Operating free-air temperature, T <sub>A</sub> | 0   |     | 70  | °C   |

# TSL12S, TSL13S, TSL14S LIGHT-TO-VOLTAGE CONVERTERS

TAOS051E – SEPTEMBER 2007

**Electrical Characteristics at  $V_{DD} = 5\text{ V}$ ,  $T_A = 25^\circ\text{C}$ ,  $\lambda_p = 640\text{ nm}$ ,  $R_L = 10\text{ k}\Omega$  (unless otherwise noted) (see Notes 3, 4, 5)**

| PARAMETER | TEST CONDITIONS             | TSL12S                               |       |      | TSL13S |       |      | TSL14S |       |      | UNIT |                                      |
|-----------|-----------------------------|--------------------------------------|-------|------|--------|-------|------|--------|-------|------|------|--------------------------------------|
|           |                             | MIN                                  | TYP   | MAX  | MIN    | TYP   | MAX  | MIN    | TYP   | MAX  |      |                                      |
| $V_{OM}$  | Maximum output voltage      | 4.6                                  | 4.9   |      | 4.6    | 4.9   |      | 4.6    | 4.9   |      | V    |                                      |
| $V_O$     | Output voltage              | $E_e = 8\ \mu\text{W}/\text{cm}^2$   | 1.5   | 2    | 2.5    |       |      |        |       |      | V    |                                      |
|           |                             | $E_e = 31\ \mu\text{W}/\text{cm}^2$  |       |      |        | 1.5   | 2    | 2.5    |       |      |      |                                      |
|           |                             | $E_e = 120\ \mu\text{W}/\text{cm}^2$ |       |      |        |       |      |        | 1.5   | 2    |      | 2.5                                  |
|           |                             | $E_e = 16\ \mu\text{W}/\text{cm}^2$  |       | 4    |        |       |      |        |       |      |      |                                      |
|           |                             | $E_e = 62\ \mu\text{W}/\text{cm}^2$  |       |      |        |       | 4    |        |       |      |      |                                      |
|           |                             | $E_e = 240\ \mu\text{W}/\text{cm}^2$ |       |      |        |       |      |        |       | 4    |      |                                      |
| $R_e$     | Irradiance responsivity     | Note 6                               | 248   |      |        | 64    |      |        | 16    |      |      | mV/<br>( $\mu\text{W}/\text{cm}^2$ ) |
| $V_{OS}$  | Extrapolated offset voltage | Note 6                               | -0.02 | 0.03 | 0.08   | -0.02 | 0.03 | 0.08   | -0.02 | 0.03 | 0.08 | V                                    |
| $V_d$     | Dark voltage                | $E_e = 0$                            | 0     |      | 0.08   | 0     |      | 0.08   | 0     |      | 0.08 | V                                    |
| $I_D$     | Supply current              | $E_e = 8\ \mu\text{W}/\text{cm}^2$   |       | 1.1  | 1.7    |       |      |        |       |      |      | mA                                   |
|           |                             | $E_e = 31\ \mu\text{W}/\text{cm}^2$  |       |      |        | 1.1   | 1.7  |        |       |      |      |                                      |
|           |                             | $E_e = 120\ \mu\text{W}/\text{cm}^2$ |       |      |        |       |      |        | 1.1   | 1.7  |      |                                      |

- NOTES: 3. Measurements are made with  $R_L = 10\text{ k}\Omega$  between output and ground.  
 4. Optical measurements are made using small-angle incident radiation from an LED optical source.  
 5. The 640 nm input irradiance  $E_e$  is supplied by an AlInGaP LED with peak wavelength  $\lambda_p = 640\text{ nm}$ .  
 6. Irradiance responsivity is characterized over the range  $V_O = 0.2$  to 4 V. The best-fit straight line of Output Voltage  $V_O$  versus irradiance  $E_e$  over this range may have a positive or negative extrapolated  $V_O$  value for  $E_e = 0$ . For low irradiance values, the output voltage  $V_O$  versus irradiance  $E_e$  characteristic is non linear with a deviation toward  $V_O = 0$ ,  $E_e = 0$  origin from the best-fit straight line referenced above.

**Dynamic Characteristics at  $V_{DD} = 5\text{ V}$ ,  $T_A = 25^\circ\text{C}$ ,  $\lambda_p = 640\text{ nm}$ ,  $R_L = 10\text{ k}\Omega$  (unless otherwise noted) (see Figure 1)**

| PARAMETER | TEST CONDITIONS  | TSL12S   |     |     | TSL13S |     |     | TSL14S |     |     | UNIT |               |
|-----------|--|--|-----|-----|--------|-----|-----|--------|-----|-----|------|---------------|
|           |  | MIN  | TYP | MAX | MIN    | TYP | MAX | MIN    | TYP | MAX |      |               |
| $t_{dr}$  | Output pulse delay time for rising edge (0% to 10%)    | Min $V_O = 0\text{ V}$ ; Peak $V_O = 2\text{ V}$   | 13  |     |        | 1.7 |     |        | 0.9 |     |      | $\mu\text{s}$ |
|           |  | Min $V_O = 0.5\text{ V}$ ; Peak $V_O = 2\text{ V}$ | 2.3 |     |        | 1.2 |     |        | 0.6 |     |      |               |
| $t_r$     | Output pulse rise time (10% to 90%)                    | Min $V_O = 0\text{ V}$ ; Peak $V_O = 2\text{ V}$   | 20  |     |        | 7.2 |     |        | 2.6 |     |      | $\mu\text{s}$ |
|           |  | Min $V_O = 0.5\text{ V}$ ; Peak $V_O = 2\text{ V}$ | 10  |     |        | 6.5 |     |        | 2.9 |     |      |               |
| $t_{df}$  | Output pulse delay time for falling edge (100% to 90%) | Min $V_O = 0\text{ V}$ ; Peak $V_O = 2\text{ V}$   | 2.3 |     |        | 1.2 |     |        | 0.8 |     |      | $\mu\text{s}$ |
|           |  | Min $V_O = 0.5\text{ V}$ ; Peak $V_O = 2\text{ V}$ | 2.2 |     |        | 1.1 |     |        | 0.7 |     |      |               |
| $t_f$     | Output pulse fall time (90% to 10%)                    | Min $V_O = 0\text{ V}$ ; Peak $V_O = 2\text{ V}$   | 10  |     |        | 6.8 |     |        | 2.9 |     |      | $\mu\text{s}$ |
|           |  | Min $V_O = 0.5\text{ V}$ ; Peak $V_O = 2\text{ V}$ | 9   |     |        | 6.4 |     |        | 2.8 |     |      |               |

# TSL12S, TSL13S, TSL14S LIGHT-TO-VOLTAGE CONVERTERS

TAOS051E – SEPTEMBER 2007

## PARAMETER MEASUREMENT INFORMATION

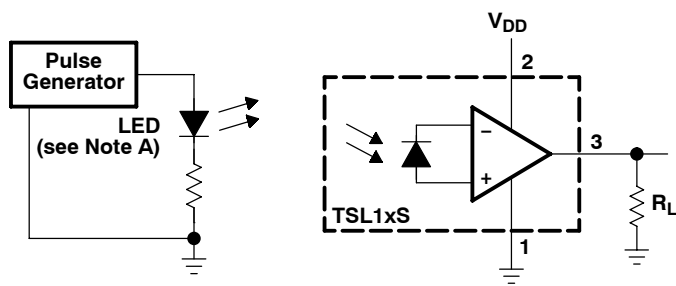

TEST CIRCUIT

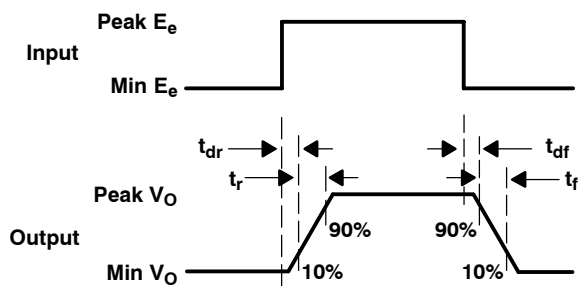

OUTPUT VOLTAGE WAVEFORM (See Note B)

- NOTES: A. The input irradiance is supplied by a pulsed AlInGaP light-emitting diode with the following characteristics:  $\lambda_p = 640 \text{ nm}$ ,  $t_r < 1 \mu\text{s}$ ,  $t_f < 1 \mu\text{s}$ .  
 B. The output waveform is monitored on an oscilloscope with the following characteristics:  $t_r < 100 \text{ ns}$ ,  $Z_i \geq 1 \text{ M}\Omega$ ,  $C_i \leq 20 \text{ pF}$ .

Figure 1. Switching Times

## TYPICAL CHARACTERISTICS

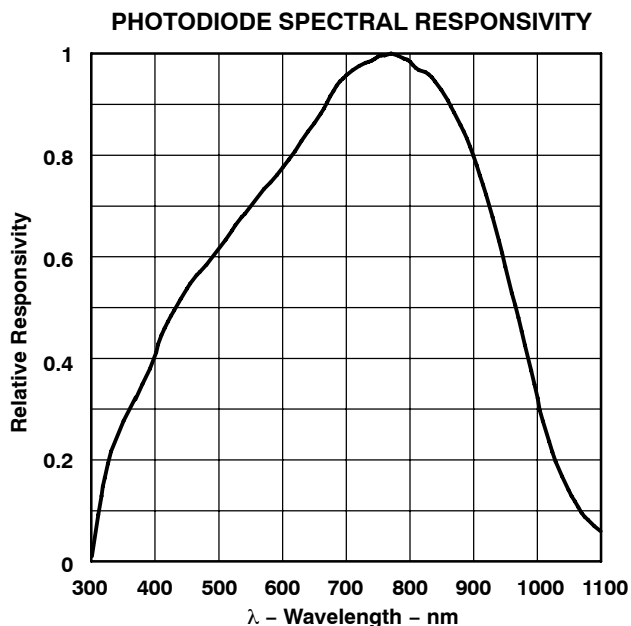

Figure 2

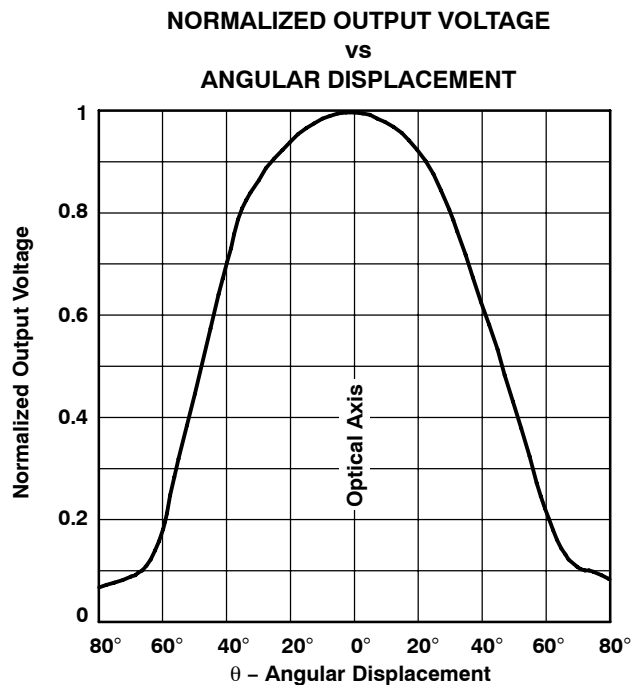

Figure 3

TYPICAL CHARACTERISTICS

TSL12S

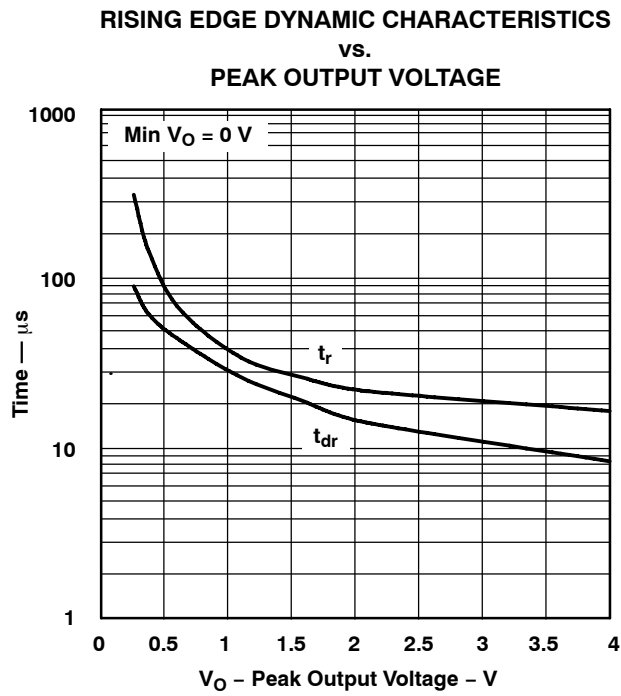

Figure 4

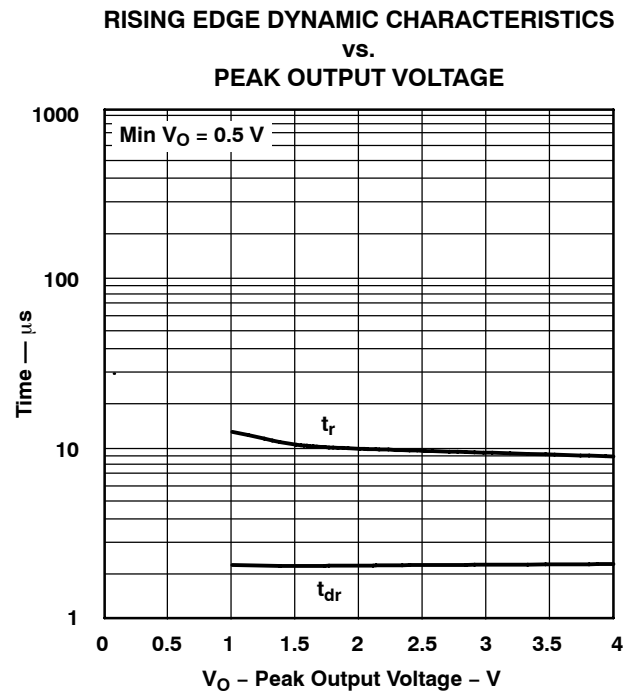

Figure 5

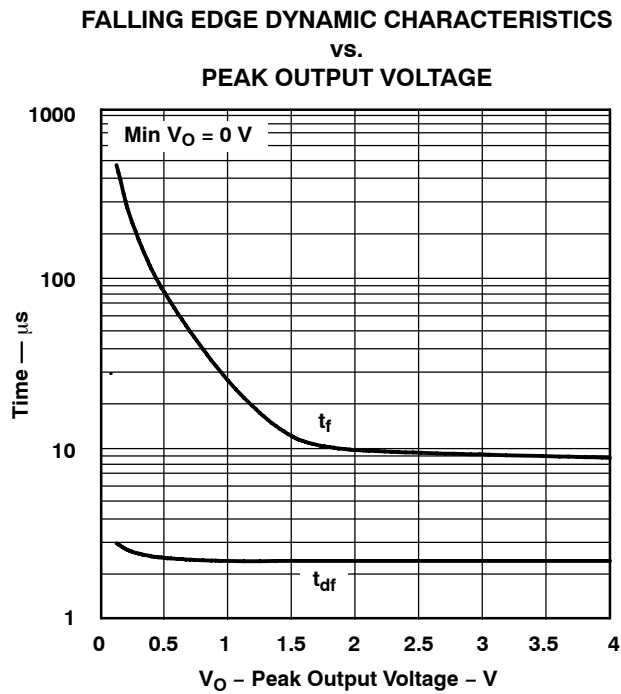

Figure 6

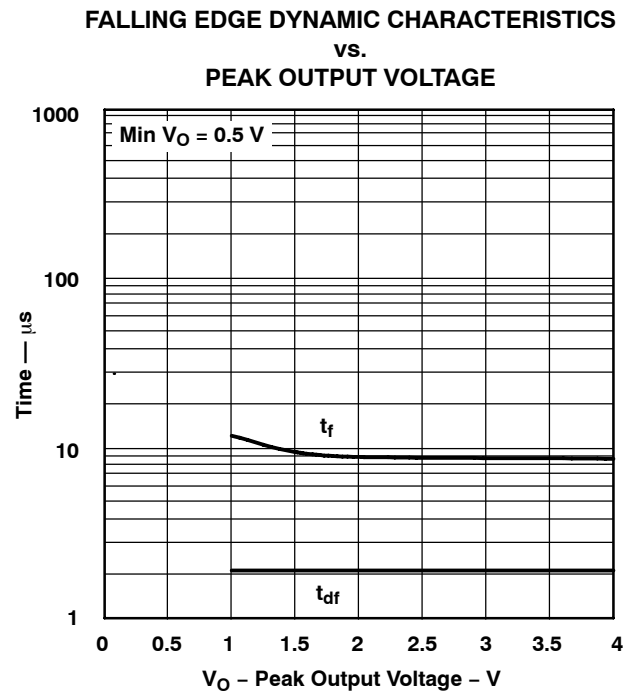

Figure 7

# TSL12S, TSL13S, TSL14S LIGHT-TO-VOLTAGE CONVERTERS

TAOS051E – SEPTEMBER 2007

## TYPICAL CHARACTERISTICS

### TSL13S

RISING EDGE DYNAMIC CHARACTERISTICS  
vs.  
PEAK OUTPUT VOLTAGE

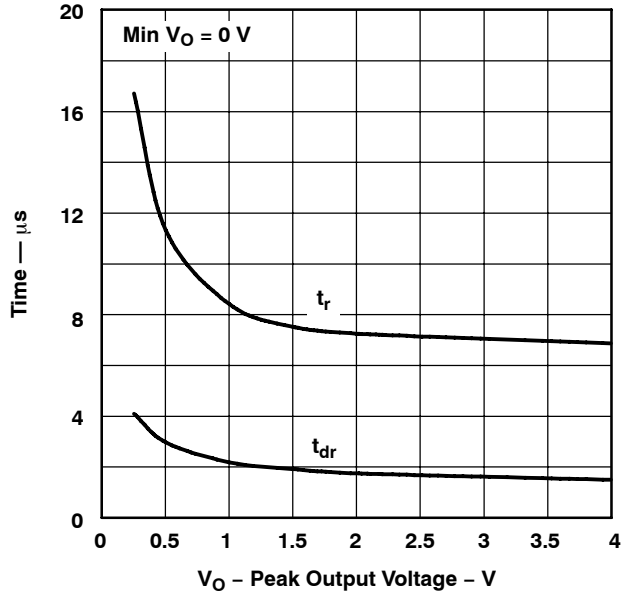

Figure 8

RISING EDGE DYNAMIC CHARACTERISTICS  
vs.  
PEAK OUTPUT VOLTAGE

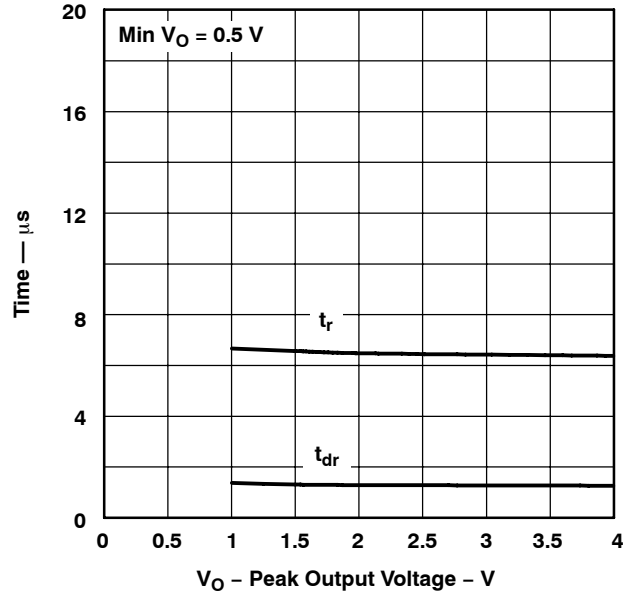

Figure 9

FALLING EDGE DYNAMIC CHARACTERISTICS  
vs.  
PEAK OUTPUT VOLTAGE

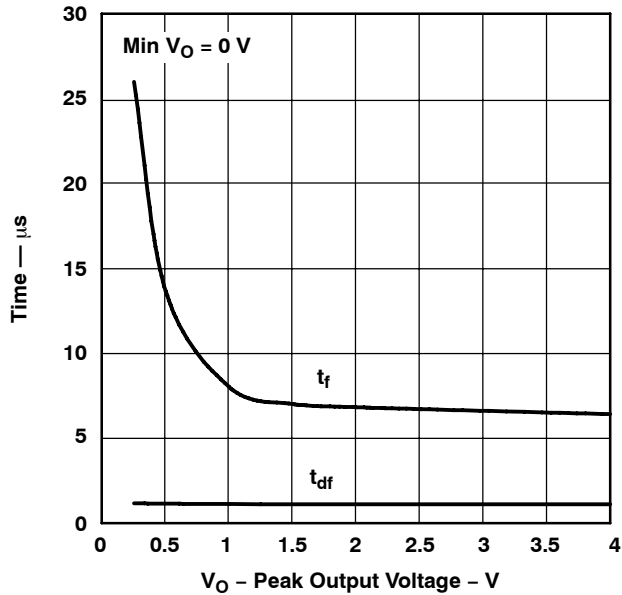

Figure 10

FALLING EDGE DYNAMIC CHARACTERISTICS  
vs.  
PEAK OUTPUT VOLTAGE

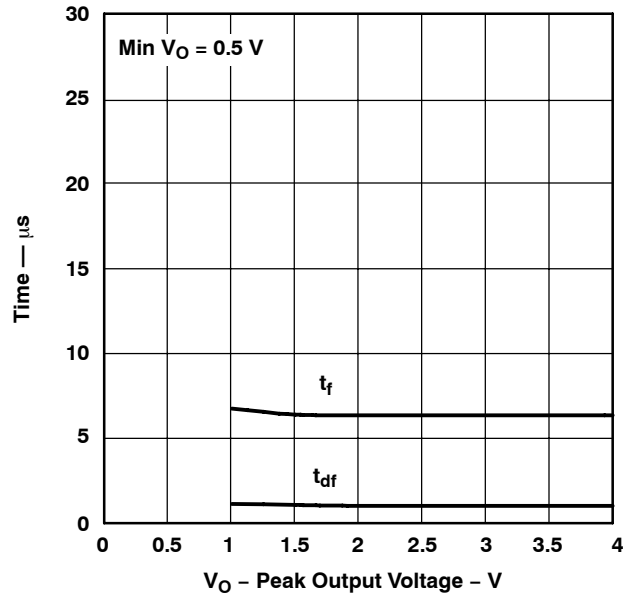

Figure 11

TYPICAL CHARACTERISTICS

TSL14S

RISING EDGE DYNAMIC CHARACTERISTICS  
vs.  
PEAK OUTPUT VOLTAGE

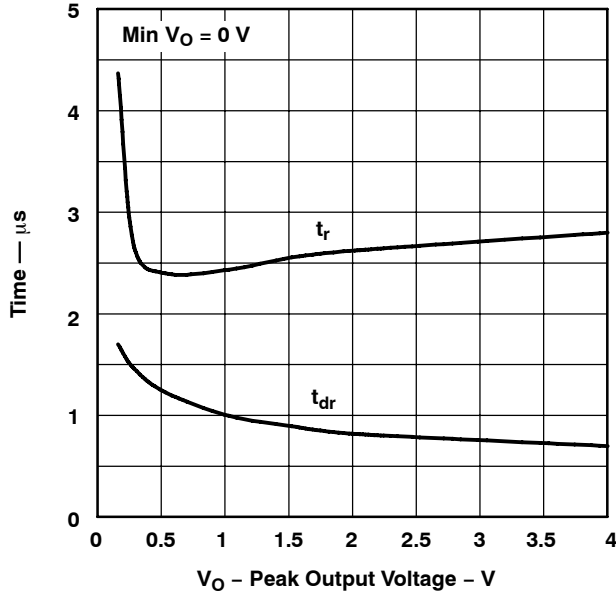

Figure 12

RISING EDGE DYNAMIC CHARACTERISTICS  
vs.  
PEAK OUTPUT VOLTAGE

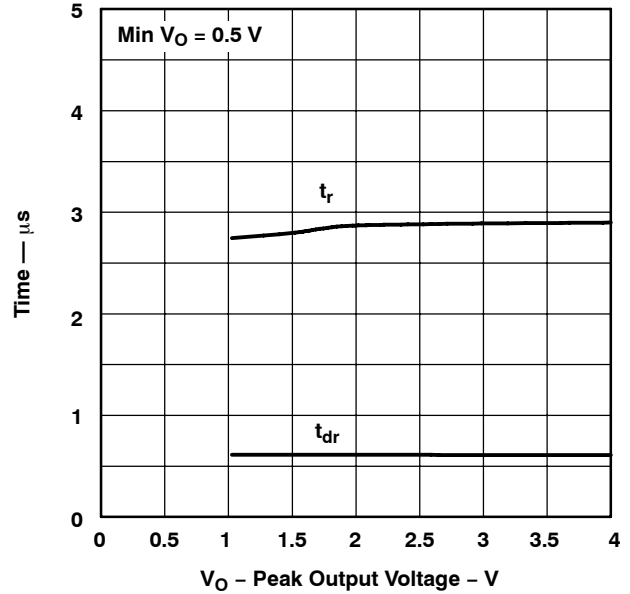

Figure 13

FALLING EDGE DYNAMIC CHARACTERISTICS  
vs.  
PEAK OUTPUT VOLTAGE

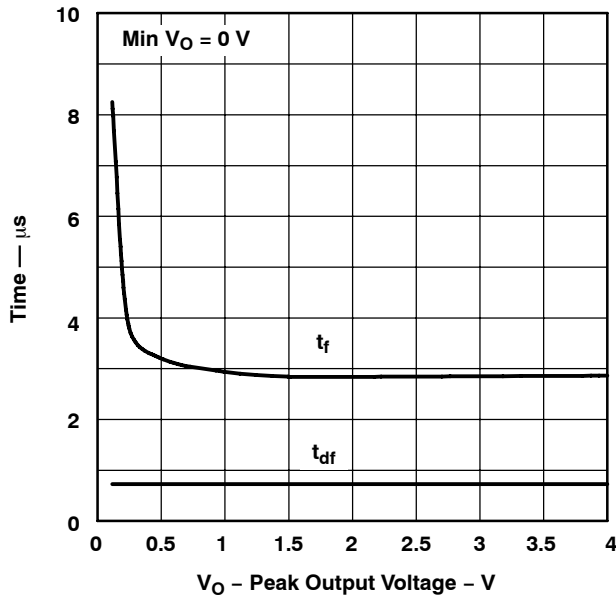

Figure 14

FALLING EDGE DYNAMIC CHARACTERISTICS  
vs.  
PEAK OUTPUT VOLTAGE

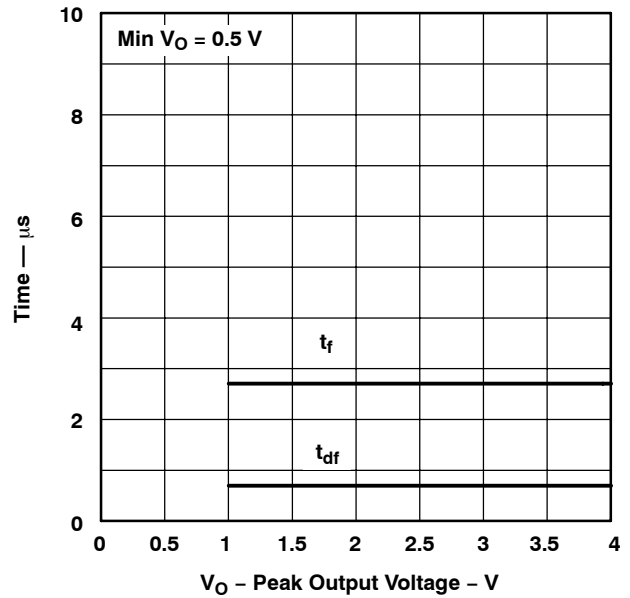

Figure 15

# TSL12S, TSL13S, TSL14S LIGHT-TO-VOLTAGE CONVERTERS

TAOS051E – SEPTEMBER 2007

## APPLICATION INFORMATION

### PCB Pad Layout

Suggested PCB pad layout guidelines for the SM surface mount package are shown in Figure 16.

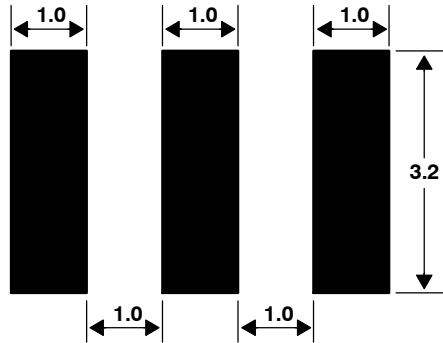

- NOTES: A. All linear dimensions are in millimeters.  
B. This drawing is subject to change without notice.

**Figure 16. Suggested SM Package PCB Layout**



MECHANICAL DATA

The TSL12S, TSL13S, and TSL14S are supplied in a clear 3-lead through-hole package with a molded lens.

PACKAGE S

PLASTIC SINGLE-IN-LINE SIDE-LOOKER PACKAGE

TOP VIEW

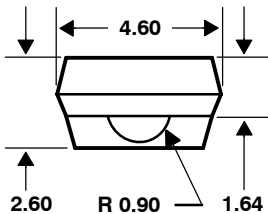

FRONT VIEW

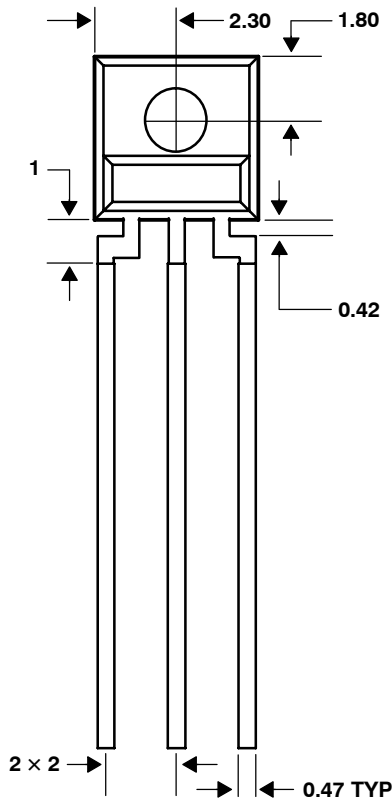

SIDE VIEW

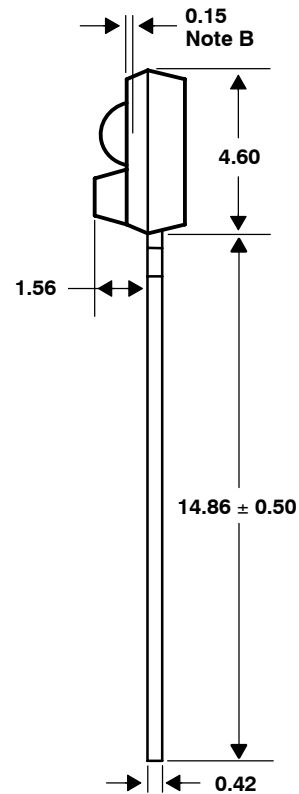

Lead Free Available

- NOTES: A. All linear dimensions are in millimeters; tolerance is  $\pm 0.25$  mm unless otherwise stated.  
 B. Dimension is to center of lens arc, which is located below the package face.  
 C. The  $0.50 \text{ mm} \times 0.50 \text{ mm}$  integrated photodiode active area is typically located in the center of the lens and  $0.97 \text{ mm}$  below the top of the lens surface.  
 D. Index of refraction of clear plastic is 1.55.  
 E. Lead finish for TSL1xS: solder dipped, 63% Sn/37% Pb. Lead finish for TSL1xS-LF: solder dipped, 100% Sn.  
 F. This drawing is subject to change without notice.

Figure 17. Package S — Single-In-Line Side-Looker Package Configuration

# TSL12S, TSL13S, TSL14S LIGHT-TO-VOLTAGE CONVERTERS

TAOS051E – SEPTEMBER 2007

## MECHANICAL DATA

### PACKAGE SM

### PLASTIC SURFACE MOUNT SIDE-LOOKER PACKAGE

#### TOP VIEW

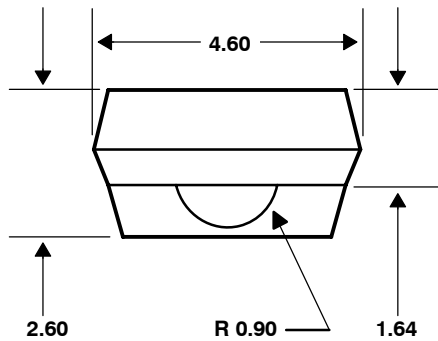

#### FRONT VIEW

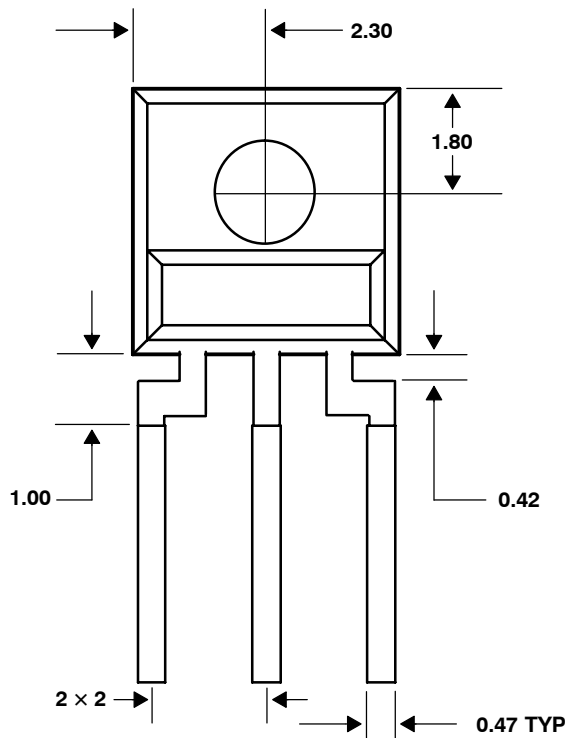

#### SIDE VIEW

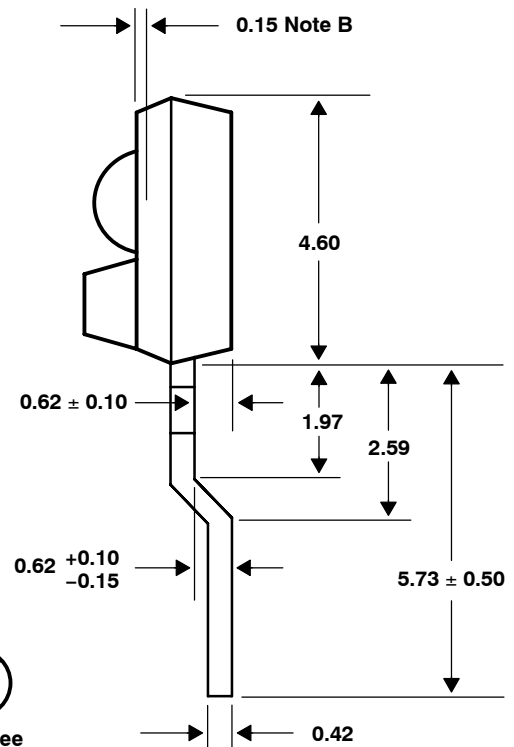

- NOTES: A. All linear dimensions are in millimeters; tolerance is  $\pm 0.25$  mm unless otherwise stated.  
 B. Dimension is to center of lens arc, which is located below the package face.  
 C. The integrated photodiode active area is typically located in the center of the lens and 0.97 mm below the top of the lens surface.  
 D. Index of refraction of clear plastic is 1.55.  
 E. Lead finish for TSL1xSM-LF: solder dipped, 100% Sn.  
 F. This drawing is subject to change without notice.

Figure 18. Package SM — Surface Mount Side-Looker Package Configuration

**PRODUCTION DATA** — information in this document is current at publication date. Products conform to specifications in accordance with the terms of Texas Advanced Optoelectronic Solutions, Inc. standard warranty. Production processing does not necessarily include testing of all parameters.

## **LEAD-FREE (Pb-FREE) and GREEN STATEMENT**

**Pb-Free (RoHS)** TAOS' terms *Lead-Free* or *Pb-Free* mean semiconductor products that are compatible with the current RoHS requirements for all 6 substances, including the requirement that lead not exceed 0.1% by weight in homogeneous materials. Where designed to be soldered at high temperatures, TAOS Pb-Free products are suitable for use in specified lead-free processes.

**Green (RoHS & no Sb/Br)** TAOS defines *Green* to mean Pb-Free (RoHS compatible), and free of Bromine (Br) and Antimony (Sb) based flame retardants (Br or Sb do not exceed 0.1% by weight in homogeneous material).

**Important Information and Disclaimer** The information provided in this statement represents TAOS' knowledge and belief as of the date that it is provided. TAOS bases its knowledge and belief on information provided by third parties, and makes no representation or warranty as to the accuracy of such information. Efforts are underway to better integrate information from third parties. TAOS has taken and continues to take reasonable steps to provide representative and accurate information but may not have conducted destructive testing or chemical analysis on incoming materials and chemicals. TAOS and TAOS suppliers consider certain information to be proprietary, and thus CAS numbers and other limited information may not be available for release.

## **NOTICE**

Texas Advanced Optoelectronic Solutions, Inc. (TAOS) reserves the right to make changes to the products contained in this document to improve performance or for any other purpose, or to discontinue them without notice. Customers are advised to contact TAOS to obtain the latest product information before placing orders or designing TAOS products into systems.

TAOS assumes no responsibility for the use of any products or circuits described in this document or customer product design, conveys no license, either expressed or implied, under any patent or other right, and makes no representation that the circuits are free of patent infringement. TAOS further makes no claim as to the suitability of its products for any particular purpose, nor does TAOS assume any liability arising out of the use of any product or circuit, and specifically disclaims any and all liability, including without limitation consequential or incidental damages.

TEXAS ADVANCED OPTOELECTRONIC SOLUTIONS, INC. PRODUCTS ARE NOT DESIGNED OR INTENDED FOR USE IN CRITICAL APPLICATIONS IN WHICH THE FAILURE OR MALFUNCTION OF THE TAOS PRODUCT MAY RESULT IN PERSONAL INJURY OR DEATH. USE OF TAOS PRODUCTS IN LIFE SUPPORT SYSTEMS IS EXPRESSLY UNAUTHORIZED AND ANY SUCH USE BY A CUSTOMER IS COMPLETELY AT THE CUSTOMER'S RISK.

LUMENOLOGY, TAOS, the TAOS logo, and Texas Advanced Optoelectronic Solutions are registered trademarks of Texas Advanced Optoelectronic Solutions Incorporated.

# TSL12S, TSL13S, TSL14S LIGHT-TO-VOLTAGE CONVERTERS

TAOS051E – SEPTEMBER 2007

---