

# Lednium Series Optimal X (10-watts, 120° Viewing Angle)

## OVTL09LG3x Series

- Revolutionary 3-dimensional packaged LED source
- Robust energy-efficient design with long operating life
- Low thermal resistance (2.5°C/W)
- Exceptional spatial uniformity
- Available in amber, blue, cyan, green, red, cool white, daylight white, warm white and multi-colored

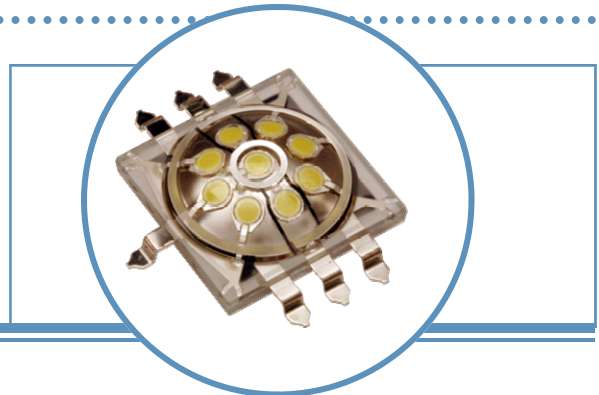

The **OVTL09LG3x Series** surface mount provides a 10-Watt energy-efficient 3-dimensional packaged LED source that offers high luminance, low thermal resistance @ 2.5°C/W and a long operating lifespan. A 120° viewing angle and three color options of white (cool, daylight, warm) make the Optimal X highly suitable for general illumination and specialized lighting applications.

## Applications

- Automotive exterior and interior lighting
- Architectural lighting
- Electronic signs and signals
- Task lighting
- General illumination

## Flux Characteristics ( $I_F = 1.05 \text{ A}$ , $T_J = 25^\circ \text{ C}$ )

Part Number	Viewing Angle	Emitted Color	Typical Luminous Flux (lm)	Lens Color
OVTL09LG3A	120°	Amber	305	Water Clear
OVTL09LG3B		Blue	105	
OVTL09LG3C		Cyan	348	
OVTL09LG3G		Green	522	
OVTL09LG3R		Red	400	
OVTL09LG3W		Cool White	565	
OVTL09LG3WD		Daylight White	522	
OVTL09LG3WW		Warm White	435	
OVTL09LG3M		Red/Green/Blue	300	

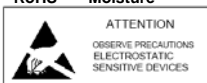

**DO NOT LOOK DIRECTLY AT LED WITH UNSHIELDED EYES OR DAMAGE TO RETINA MAY OCCUR.**

OPTEK reserves the right to make changes at any time in order to improve design and to supply the best product possible.

# Lednium Series Optimal X

## OVTL09LG3x Series

### Package Drawing:

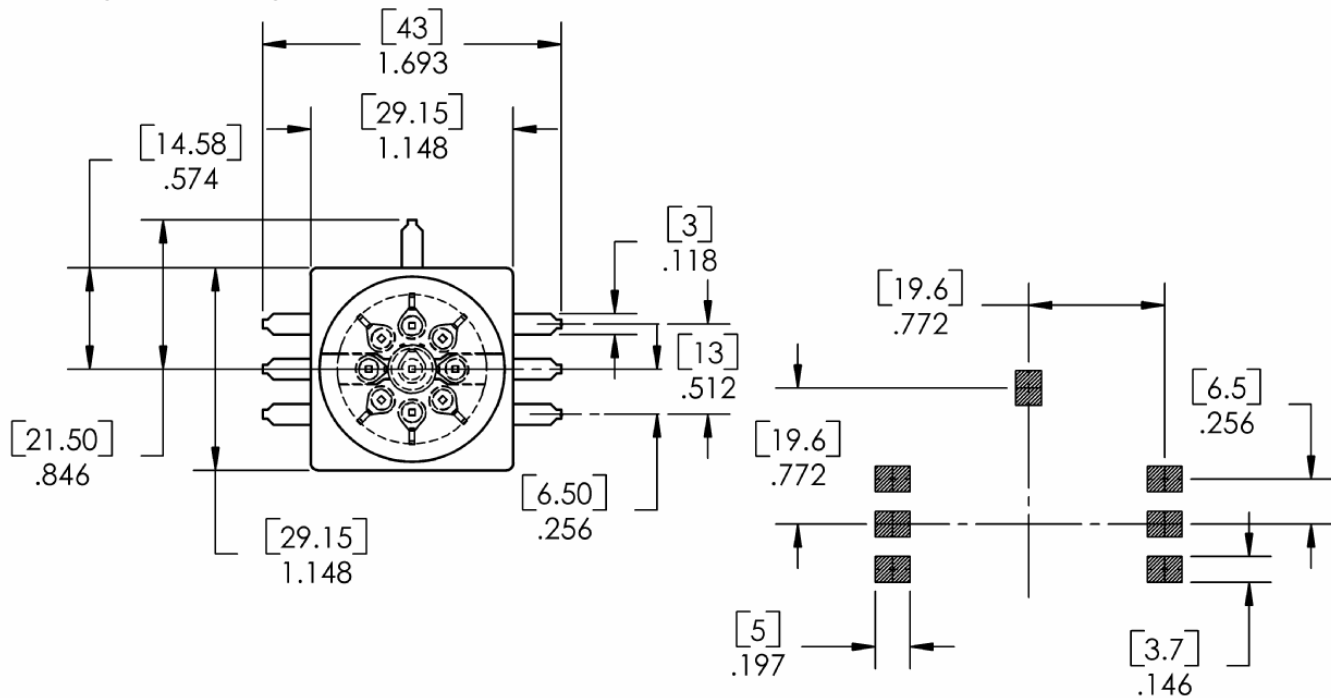

PRINTED CIRCUIT BOARD FOOTPRINT

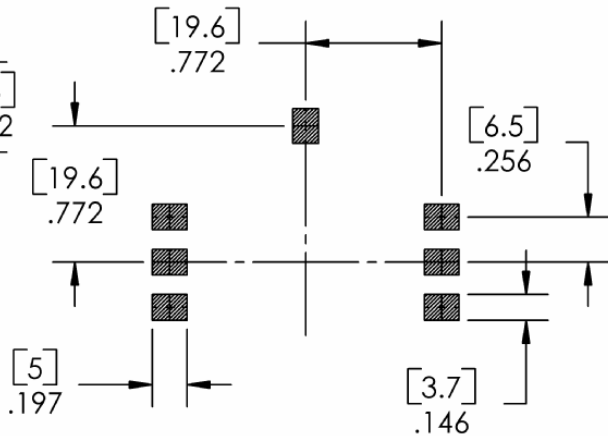

DIMENSIONS ARE IN INCHES [MM]

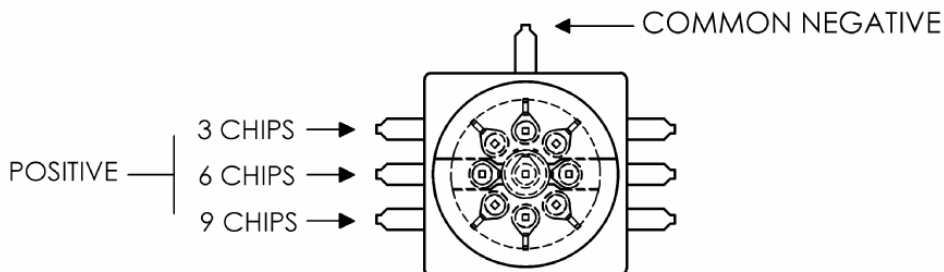
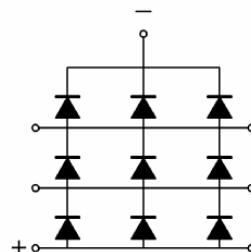

OPTeK reserves the right to make changes at any time in order to improve design and to supply the best product possible.

# Lednium Series Optimal X

## OVTL09LG3x Series



### Absolute Maximum Ratings

DC Forward Current	1.05 A
Peak Pulsed Forward Current <sup>1</sup>	3 A
Reverse Voltage	15 V
Maximum Allowable Junction Temperature <sup>2</sup>	130° C
Storage and Operating Temperature	-50° ~ +85° C

Notes:

1. Pulse width 1 ms maximum, duty cycle 1/16.
2. Thermal resistance junction to board ( $T_{JB}$ ) is 2.5° C/W.

### Electrical Characteristics ( $I_F = 1.05$ A, $T_J = 25^\circ$ C)

SYMBOL	PARAMETER	MIN	TYP	MAX	UNITS
$V_F$	Forward Voltage (Amber)	5.7	6.9	7.8	V
	Forward Voltage (Blue)	8.7	10.2	11.1	V
	Forward Voltage (Green & Cyan)	9.6	10.8	12.0	V
	Forward Voltage (Red)	5.7	6.9	7.8	V
	Forward Voltage (Red/Green/Blue)	8.5	9.2	9.9	V
	Forward Voltage (White)	8.7	10.2	11.1	V
	$V_F$ Temperature Co-efficient (Amber, Red)	----	-6.0	----	mV/°C
	$V_F$ Temperature Co-efficient (White, Blue)	----	-4.8	----	mV/°C
	$V_F$ Temperature Co-efficient (Green & Cyan)	----	-5.0	----	mV/°C
2 $\Theta_{1/2}$	50% Power Angle	----	120	----	deg

### Optical Characteristics ( $I_F = 1.05$ A, $T_J = 25^\circ$ C)

COLOR	DOMINANT WAVELENGTH			SPECTRAL FULL-WIDTH-HALF-MAXIMUM	DOMINANT WAVELENGTH TEMPERATURE DEPENDENCE
	MIN	TYP	MAX		
Amber	590	595	600	16 nm	0.08 nm/° C
Blue	455	460	465	24 nm	0.05 nm/° C
Cyan	500	505	510	37nm	0.04 nm/° C
Green	510	515	520	40 nm	0.04 nm/° C
Red	620	625	630	18 nm	0.05 nm/° C

Color	Minimum CCT (°K)	Maximum CCT (°K)	Chromaticity Coordinates				
Cool White	6400	7600	$C_x$	.298	.304	.316	.313
			$C_y$	.314	.297	.318	.340
Daylight White	5200	6400	$C_x$	.313	.317	.336	.338
			$C_y$	.341	.313	.345	.382
Warm White	3200	3800	$C_x$	.388	.403	.440	.419
			$C_y$	.375	.424	.440	.391

OPTEK reserves the right to make changes at any time in order to improve design and to supply the best product possible.

# Lednium Series Optimal X

## OVTL09LG3 Series



### Standard Bins

Lamps are sorted to luminous flux ( $\Phi$ ) and forward voltage ( $V_F$ ) bins shown. Orders may be filled with any or all bins contained as below.

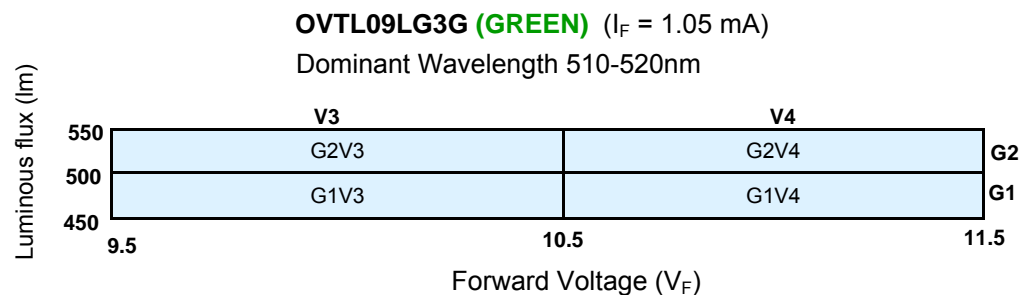
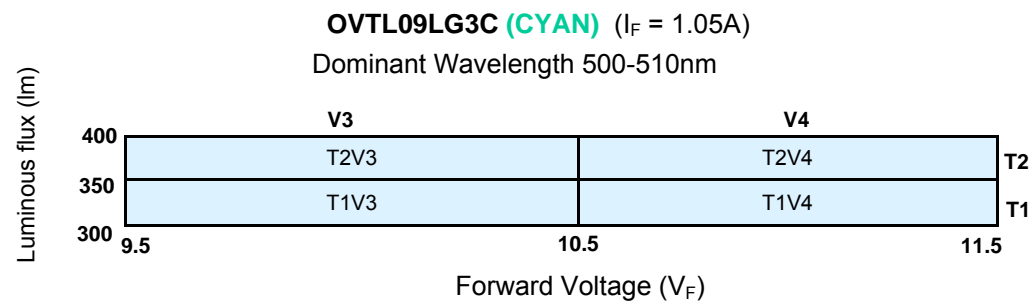
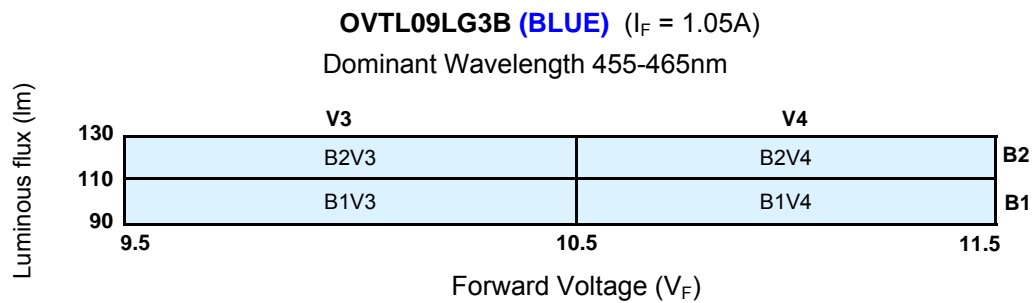
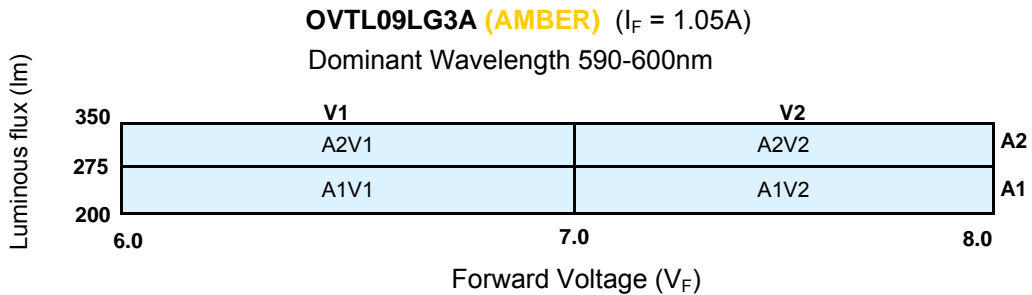

### Important Notes:

1. All ranks will be included per delivery, rank ratio will be based on the chip distribution.
2. To designate forward voltage and luminous flux ranks, please contact OPTeK.

OPTeK reserves the right to make changes at any time in order to improve design and to supply the best product possible.

# Lednium Series Optimal X

## OVTL09LG3 Series



### Standard Bins

Lamps are sorted to luminous flux ( $\Phi$ ) and forward voltage ( $V_F$ ) bins shown. Orders may be filled with any or all bins contained as below.

#### OVTL09LG3R (RED) ( $I_F = 1.05A$ )

Dominant Wavelength 620-630nm

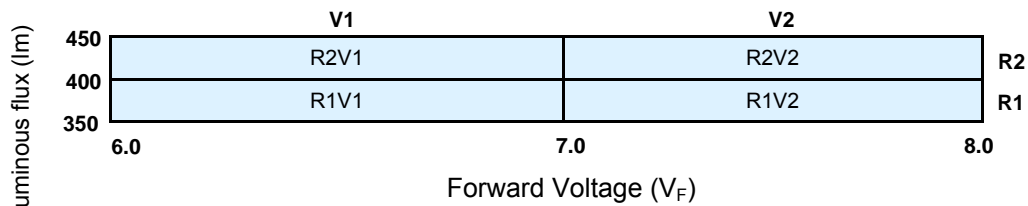

#### OVTL09LG3W (COOL WHITE) ( $I_F = 1.05A$ )

Typical CCT 7000°K ( $\pm 600^\circ K$ )

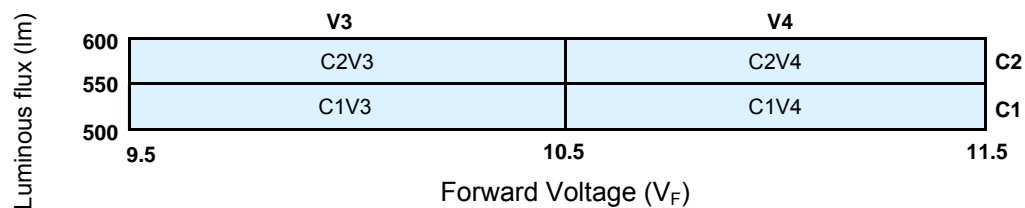

#### OVTL09LG3WD (DAYLIGHT WHITE) ( $I_F = 1.05 A$ )

Typical CCT 5800°K ( $\pm 600^\circ K$ )

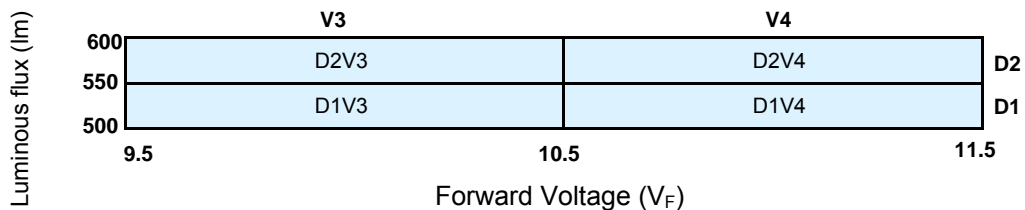

#### OVTL01LGAWW and OVTL01LGAWWS (WARM WHITE) ( $I_F = 350 mA$ )

Typical CCT 3500°K ( $\pm 300^\circ K$ )

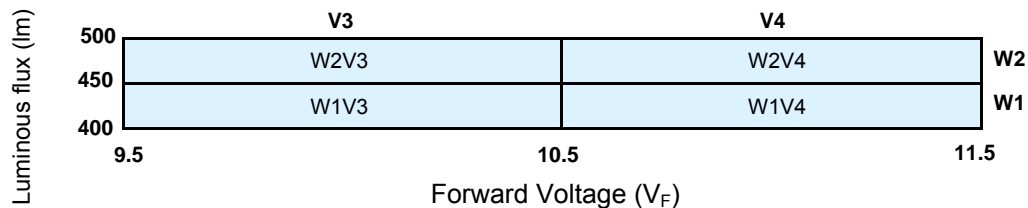

OPTEK reserves the right to make changes at any time in order to improve design and to supply the best product possible.

White Color Bins

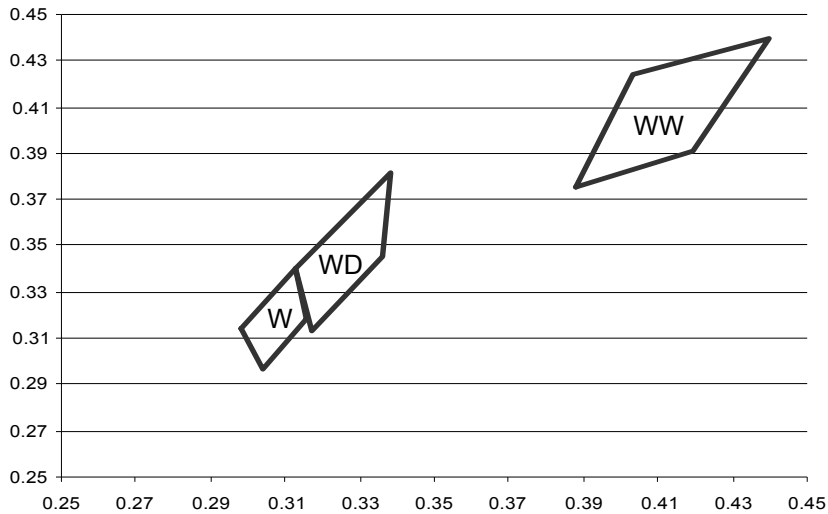

	Color	CCT
<b>W</b>	Cool White	7000°K ± 600
<b>WD</b>	Daylight White	5800°K ± 600
<b>WW</b>	Warm White	3500°K ± 300

White Color Bins

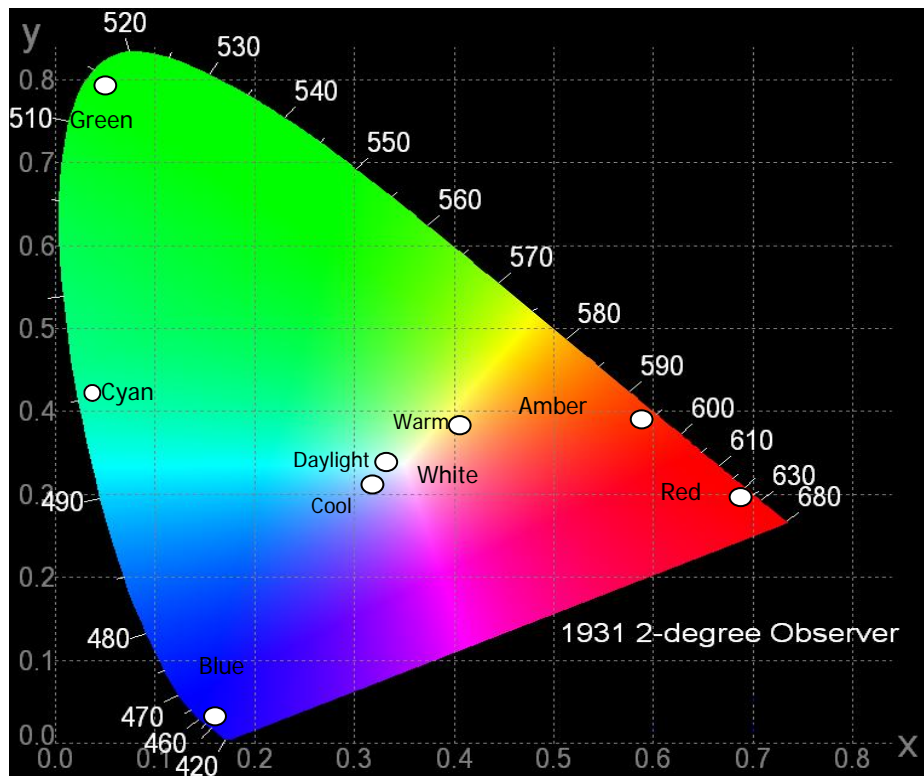

OPTEK reserves the right to make changes at any time in order to improve design and to supply the best product possible.

### Dimming and color mixing for OVTL09LG3M

In the diagram below if each parallel group of three LEDs is a single color the luminous flux produced is a mixture of R + G + B. To change the emission level of any group (color), and therefore the color of the mixed light, the current passing through each group must be changed, yet the circuit current remains a constant value. The means of doing this is to shunt current away from a group while allowing the total circuit current to remain constant.

By controlling the operating point of the three shunt transistors, the operating current of each group of LEDs can be independently and continuously adjusted. The transistors will turn OFF (short across) each strip individually when they are ON. The frequency for PWMs should be high to eliminate flickering (more than 20KHz preferred). Controlling the ON time for each strip will control the average intensity of each strip in order to color-mix the RGB Turtle.

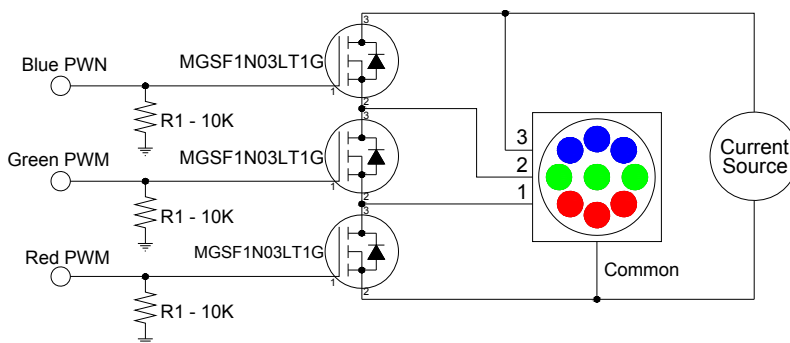

### Spatial Intensity Distribution

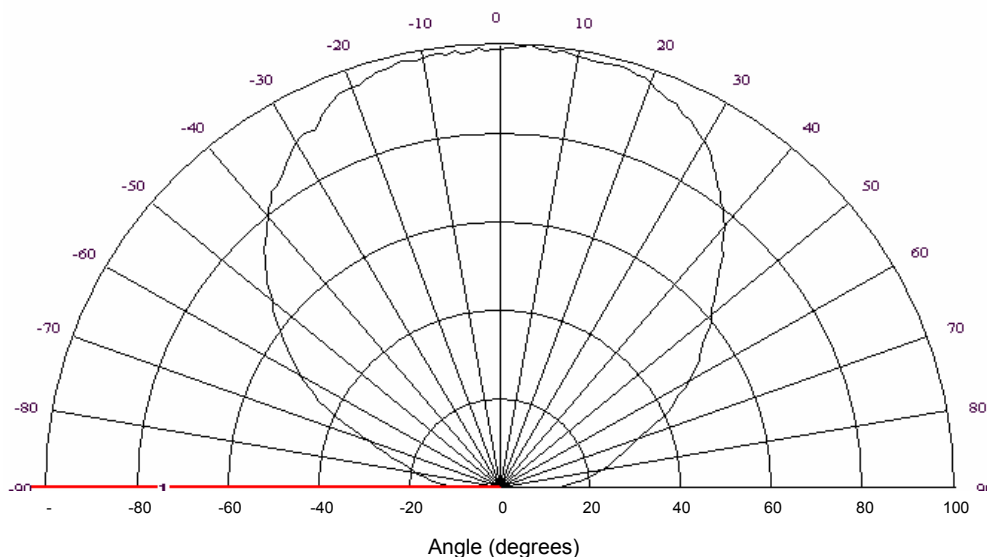

Normalized Spectral Intensity vs Angular Displacement

OPTEK reserves the right to make changes at any time in order to improve design and to supply the best product possible.



### Typical Electro-Optical Characteristics Curves

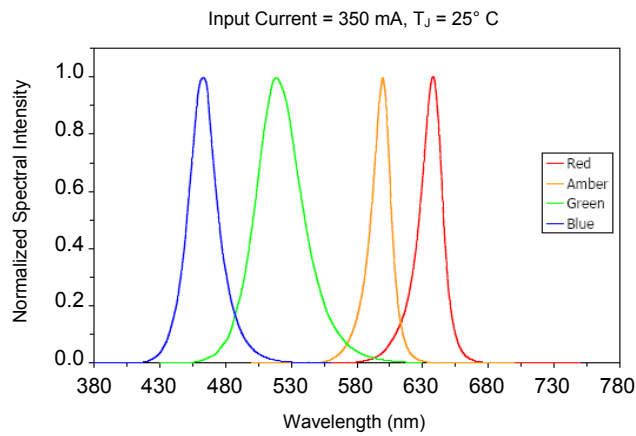

Wavelength Characteristics

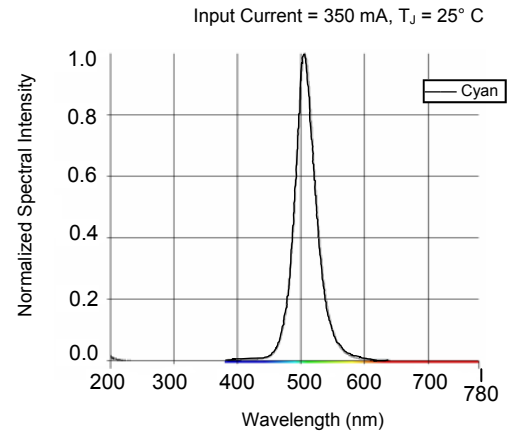

Wavelength Characteristics

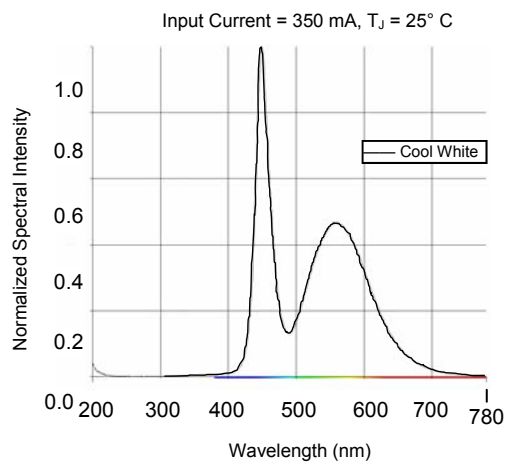

Wavelength Characteristics

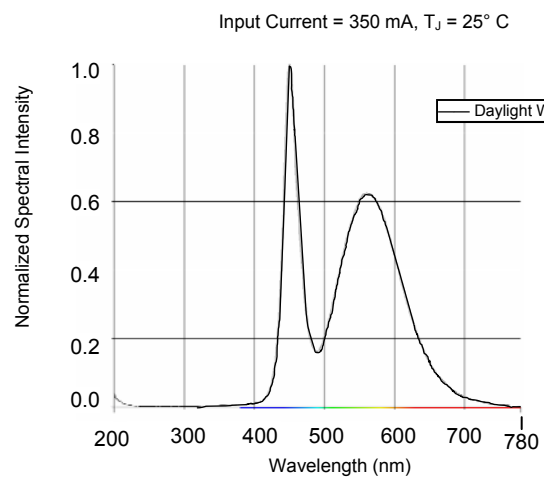

Wavelength Characteristics

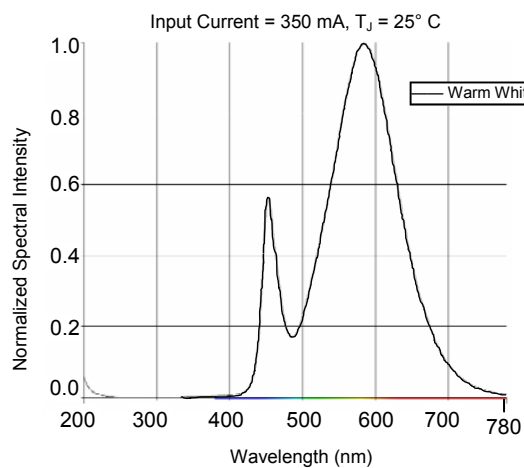

Wavelength Characteristics

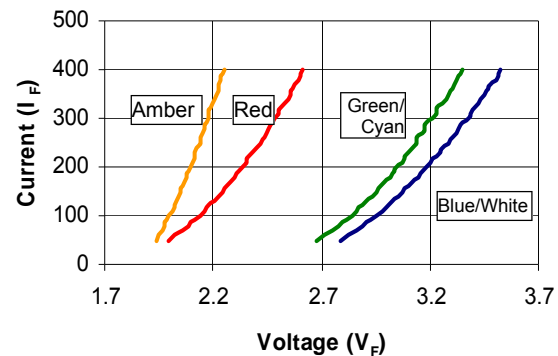

Forward Current vs. Forward Voltage

OPTeK reserves the right to make changes at any time in order to improve design and to supply the best product possible.



# Lednium Series Optimal X

## OVTL09LG3x Series



### Typical Electro-Optical Characteristics Curves

Luminosity normalized to  $T_J = 25^\circ\text{C}$

OPTeK Part Number	% Normalized Luminosity at Junction Temperature ( $^\circ\text{C}$ )					
	0	25	50	75	100	125
OVTL09LG3A	125	100	85	70	60	45
OVTL09LG3B	107	100	95	87	75	65
OVTL09LG3C	110	100	95	85	70	65
OVTL09LG3G	110	100	95	85	70	65
OVTL09LG3R	135	100	90	75	65	50
OVTL09LG3W	105	100	93	82	68	60
OVTL09LG3WD	105	100	93	82	68	60
OVTL09LG3WW	105	100	93	82	68	60
OVTL09LG3M	110	100	95	85	70	65

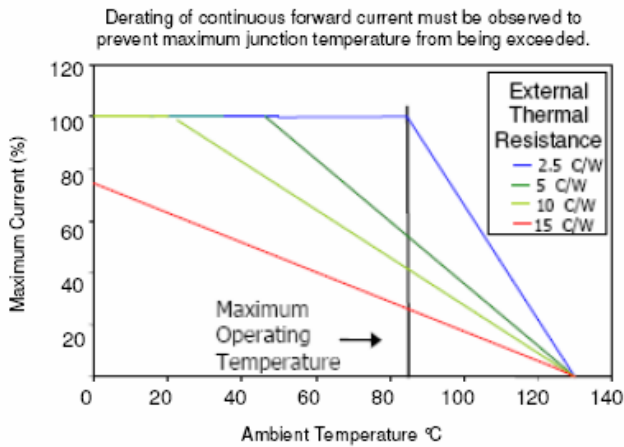
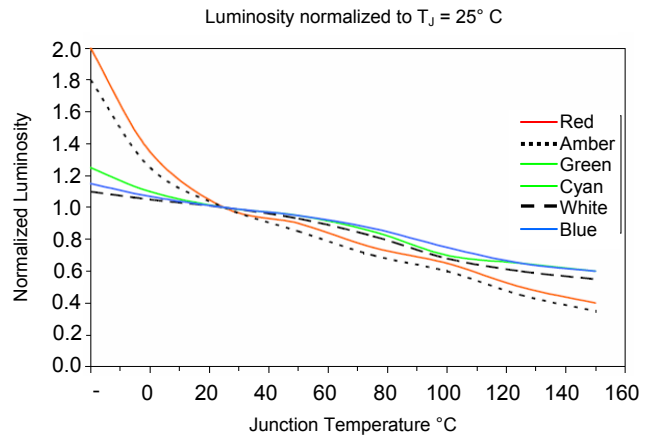

Derating Curves - Blue, Green and White LEDs

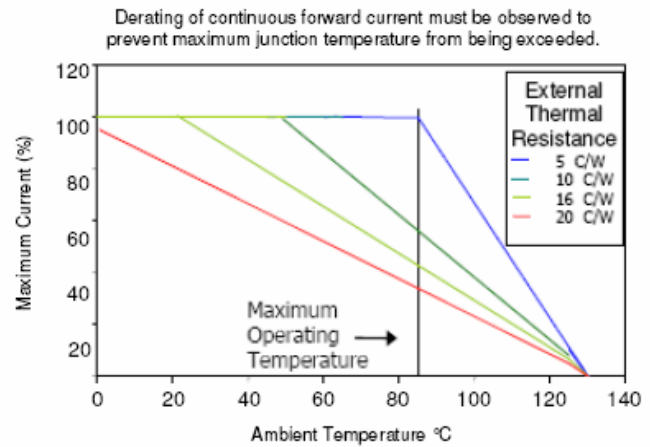

Derating Curves - Amber and Red LEDs

### Critical Thermal Conditions (To maintain junction temperature ( $T_J$ ) at $85^\circ\text{C}$ )

	WHEN MOUNTED ON:				
	FR4 PC BOARD	IMS	SPREADER PLATE	3x3x1 in. FIN EXTRUSION	ACTIVE HEATSINK
<b>USE SAFE OPERATING CURRENT OF:</b>	200 mA	500 mA	700 mA	800 mA	1000 mA

**NOTE:** Refer to OPTeK Application Note #228 on thermal management ([www.optekinc.com/pdf/AppNote228.pdf](http://www.optekinc.com/pdf/AppNote228.pdf)).

OPTeK reserves the right to make changes at any time in order to improve design and to supply the best product possible.

# Lednium Series Optimal X

## OVTL09LG3x Series

### OPTEK 10-watt Lednium Markings

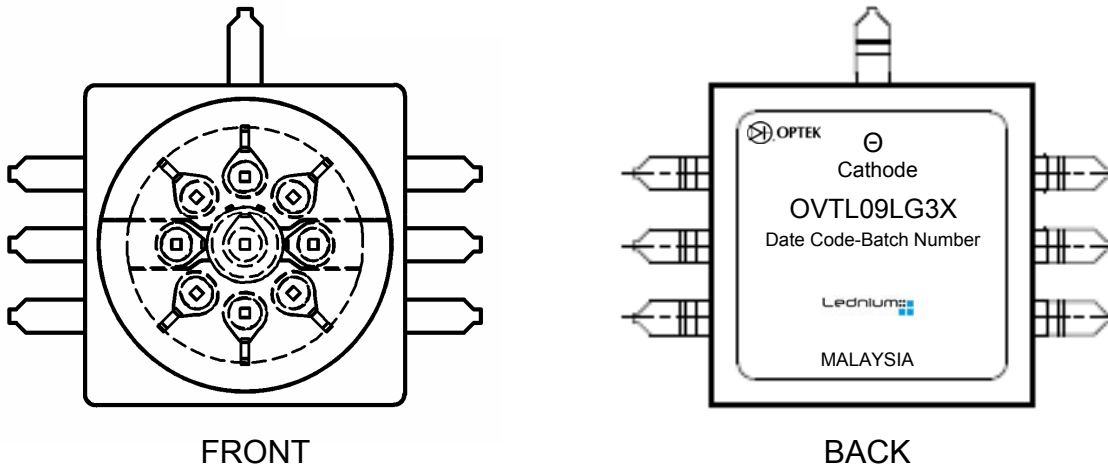

Packaging: 25 pieces per tray

**OPTEK's Lednium Series Solid State Lighting products package the highest quality LED chips. Typically, the lumen output of these chips can be as high as 70% after 50,000 hours of operation. This prediction is based on specific test results and on tests on similar materials, and relies on strict observation of the design limits and ratings included in this data sheet.**

OPTEK reserves the right to make changes at any time in order to improve design and to supply the best product possible.

## Thermal Resistance

Optek Lednium Series 1-watt Cup – Measured value 2°C/w (OVTL01LGAxx)

Optek Lednium Series 10-watt Matrix – Measured value 2.5°C/w (OVTL09LG3xx)

### Theory

In line with industry practice, the thermal resistance ( $R_{th}$ ) of our LED packages is stated as  $R_{\theta_{j-b}}$ , thermal resistance from the junction region (j) of the die, to the board (b) - PCB or other mounting surface. What this means in a practical sense, is that when operating at rated input (1 watt approx.) the junction of a die in a cup product will attain a temperature that is 2°C higher than a reference point on the mounting surface beneath it. In the case of a 10-watt Matrix product, the maximum temperature difference between any junction and the reference point is 25°C (2.5°C/w x 10w). The thermal path thus quantified is a composite of a number of thermally resistive elements in a series and or parallel configuration, but lumped together into a single parameter for convenience.

For an end user of LED products then, this constant allows the junction temperature to be determined by a simple measurement of the temperature of the mounting surface. Optek recommends that the design value of sustained die junction temperature be limited to 80°C. In an ambient temperature of 25°C, the board temperature of a 10-watt device must be constrained below 55°C to comply with this recommendation, and for a 1-watt cup the board can theoretically operate at up to 78°C.

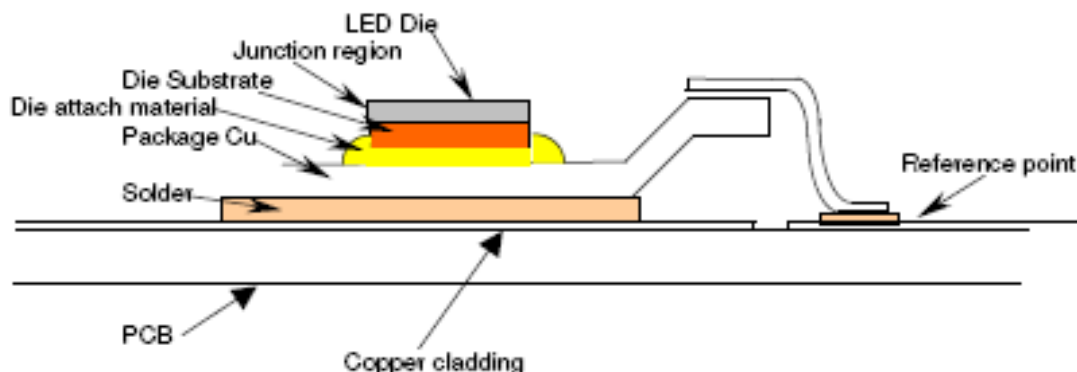

From the diagram above it can be seen that the heat generated in the junction region follows a somewhat serial conductive path through the package to the major radiating surface – which in this example is a single sided PCB. Some additional radiation may occur directly from the upper surface of the package (not shown). This would be conducted upward from the die surface through the transparent encapsulating material to the package surface and be radiated from there. To all practical purposes this is a very minor effect. The polymer encapsulants in normal use are poor conductors of heat.

OPTEK reserves the right to make changes at any time in order to improve design and to supply the best product possible.

Typical elements in the conducting path and corresponding nominal thermal conductivities are:

	Elements	w/mK
Epilayers	GaN/InGaN	150
Substrate	Sapphire	50
Die attach material	Conductive epoxy	10
Package	Silver plated copper	350
Solder	Solder (Sn/Ag/Cu)	35
Copper cladding	Copper	300

Note : Thermal conductivity is a physical constant. For the materials above, the respective contribution each makes to the overall thermal resistance ( $R_{\theta j-b}$ ) is a function of the thickness of each material layer, and the surface area. Thermal Conductivity (TC) is defined to be the heat conducted in time (t), through thickness (T) in a direction normal to a surface area (A), due to a temperature difference ( $\delta T$ ).

Therefore  $TC = q/t \times \{T/[A \times \delta T]\}$

and  $\delta T = [Q \times T]/[A \times TC]$  where  $\delta T =$  Temp. difference (K)  
 $Q =$  Power (w)  
 $A =$  Surface area ( $m^2$ )  
 $T =$  layer thickness (m)  
 $TC =$  Thermal Conductivity (w/mK)

Theoretical Calculation (for 1 watt dissipated in a cup product via a single 40mil die)

GaN	Thickness approx $10 \times 10^{-6}$ Area $10^{-6}$	$= 1 \times 10 \times 10^{-6} / 10^{-6} \times 150$ $= 0.07 \text{ K}$
Substrate	$T = 60 \times 10^{-6}$	$= 1 \times 60 \times 10^{-6} / 10^{-6} \times 50$ $= 1.2 \text{ K}$
Die attach	$T = 20 \times 10^{-6}$ $A = 2 \times 10^{-6}$	$= 1 \times 20 \times 10^{-6} / 2 \times 10^{-6} \times 10$ $= 1$
Package	$T = 0.4 \times 10^{-3}$ $A = 6 \times 10^{-6}$	$= 1 \times 0.4 \times 10^{-3} / 6 \times 10^{-6} \times 350$ $= 0.19$
Solder	$T = 60 \times 10^{-6}$ $A = 6 \times 10^{-6}$	$= 1 \times 60 \times 10^{-6} / 6 \times 10^{-6} \times 25$ $= 0.4$

Total Calculated  $\delta T = 2.86\text{K}$

OPTEK reserves the right to make changes at any time in order to improve design and to supply the best product possible.

Power input is 1 watt; however, some power is converted into light energy. Assuming this is of the order of 200mw, the adjusted value of  $\delta T$  is 2.29K. The calculation now assumes that all of the dissipation, 800mw of heat, is conducted along the thermal path, thereby ignoring any conduction and subsequent radiation that is not directionally normal to the surfaces considered, ie: conduction through the encapsulant material vertically away from the board, and conduction horizontally away from the heat source. The calculation also assumes that there is no contribution to thermal resistance at the boundaries between material layers. In practice it is improbable that perfect transfer will occur at these transition regions, even though the bonding between layers in this example are of high quality. In general, the calculation indicates that the measurements below are of the order of magnitude that can be expected.

The alternate matrix product range is of a much more complicated thermal design, which does not lend itself to a simple theoretical calculation similar to that shown above. There are multiple incident heat sources, parallel heat conduction paths, and significantly larger surface area for stray radiation, eg. Cup above has a surface area available for stray radiation of approximately, 25mm<sup>2</sup> per watt of input power. A 10-watt matrix product has approximately 92.5mm<sup>2</sup> of exposed surface per input watt.

### Measurements

The key to an accurate measurement of thermal resistance is to obtain a reliable value for the junction temperature ( $T_j$ ). Since the die itself is, and must be, encapsulated during testing, and the junction is contained within the structure of the die, direct measurement of the junction temperature by normal means is not possible. Two methods of non-contact thermography are available, both of which rely on emitted infrared detection.

Infrared imagery by calibrated radiograph is a possibility; however, in the instance of a cup product only a small value of  $\delta T$  is expected which makes accurate estimation of the actual temperature gradient difficult using colorimetry.

The alternative measurement type is digital infrared thermography. This means there is an inherent uncertainty in the calculation algorithm, which sometimes gives results considered unacceptably inaccurate. In this instance absolute accuracy is of secondary importance because the value to be determined is a temperature difference ( $\delta T$ ) which requires only relative values – any error in a first reading will also be present in subsequent readings that are about the same value. The difference between readings is accurate.

The other significant drawback to infrared thermometers is a limitation to minimizing the spot size over which the measurement is made. This poses a difficulty for small assemblies like an LED cup, and in particular the added complication that the calculated temperature is an average value for the area being interrogated further complicates the issue. Another concern is sometimes raised about the ability of this type of instrument to detect a heated surface beyond the closest transparent radiating surface. This is a significant issue for far field measurements; however, it is simple to demonstrate that this does not hold true for the near field, and particularly when the incident beam has a known focal length.

OPTEK reserves the right to make changes at any time in order to improve design and to supply the best product possible.

# Lednium Series Optimal X

## OVTL09LG3x Series

### Measurement

Instrument: IR Thermometer  
 Auto ranging: -100 to 1200°C  
 Spot size 3mm D.  
 Focus 25.4mm

### Optimal I Product

Input 350mA at 3.3V(1watt)



Device under test

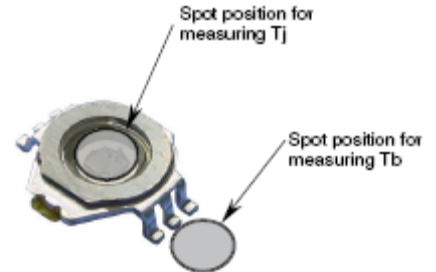

### Averaged Test Results

$T_j$	$T_b$	$\delta T$
32	30.2	1.8

<b>Rth</b>
<b>1.8°C/W</b>

### Optimal X Product

Input 1050mA at 10.2V(10.7watts)

### Averaged Test Results

$T_j$	$T_b$	$\delta T$
89	62	27

<b>Rth</b>
<b>2.52°C/W</b>

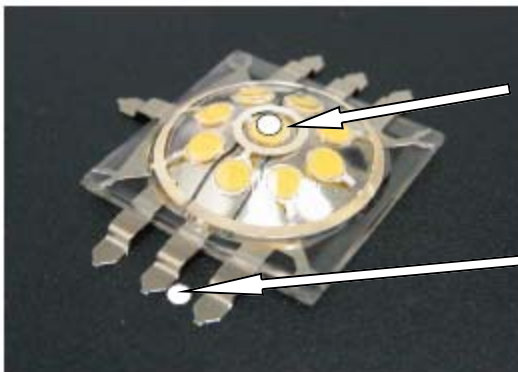

Measurement points



Test set-up on MCPCB

OPTEK reserves the right to make changes at any time in order to improve design and to supply the best product possible.