

High Radiant Flux Density
365nm UV LED Emitter

LZC-00U600



Key Features

- Ultra-bright, compact 12-die, 365nm UV LED
- Very high Radiant Flux density, 10 W/cm²
- Small high density foot print, 9.0mm x 9.0mm x 5.4mm
- Surface mount ceramic package with integrated glass lens
- Exceptionally low Thermal Resistance (0.7°C/W)
- Electrically neutral thermal slug
- Autoclave complaint (JEDEC JESD22-A102-C)
- JEDEC Level 1 for Moisture Sensitivity Level
- Lead (Pb) free and RoHS compliant
- Reflow solderable (up to 6 cycles)
- Emitter available on MCPCB (optional)

Typical Applications

- Curing
- Sterilization
- Medical
- Currency Verification
- Fluorescence Microscopy
- Inspection of dyes, rodent and animal contamination,
- Leak detection
- Forensics

Description

The LZC-series emitter is rated for 40W power handling in an ultra compact package. With a small 9.0mm x 9.0mm x 5.4mm footprint, this package provides exceptional radiant flux density. The patented design has unparalleled thermal and optical performance. The high quality materials used in the package are chosen to optimize Radiant Flux and minimize stresses which results in monumental reliability and radiant flux maintenance. The robust product design thrives in outdoor applications with high ambient temperatures and high humidity.

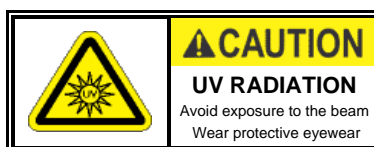

Table of Contents

Product Nomenclature	3
IPC/JEDEC Moisture Sensitivity	3
Luminous Flux Binning.	4
Dominant Wavelength Binning	4
Forward Voltage Binning	4
Absolute Maximum Ratings	5
Optical Characteristics	5
Electrical Characteristics	5
Mechanical Dimensions	6
Pin-Out	6
Recommended Solder Pad Layout	6
Reflow Soldering Profile	7
Typical Radiation Pattern	7
Typical Relative Spectral Power Distribution	8
Typical Relative Dominant Wavelength Shift over Temperature	8
Typical Relative Radiant Flux	9
Typical Relative Radiant Flux over Temperature	9
Typical Forward Current Characteristics	10
Current Derating Curves	10
Emitter Tape & Reel Specifications	11
MCPCB Options.	12
Company Information	14

Product Nomenclature

The LZ Series part number designation is defined as follows:

L Z A – B C D E 0 0

Where:

A – designate the number of LED die locations inside the package (“C” for 12-die)

B – designate the package level (“0” for Emitter)

C – designate the radiation pattern (“0” for Lambertian)

D and E – designate the color (“U6” for UV - 365nm Peak Wavelength)

Ordering information:

For ordering LedEngin products, please reference the base part number. The base part number represents any of the flux, dominant wavelength, or forward voltage bins specified in the binning tables below. For ordering products with special bin selections, please contact a LedEngin sales representative or authorized distributor.

IPC/JEDEC Moisture Sensitivity Level

Table 1 - IPC/JEDEC J-STD-20D.1 MSL Classification:

Level	Floor Life		Soak Requirements			
	Time	Conditions	Standard Time (hrs)	Standard Conditions	Accelerated Time (hrs)	Accelerated Conditions
1	Unlimited	≤ 30°C/ 85% RH	168 +5/-0	85°C/ 85% RH	n/a	n/a

Notes for Table 1:

1. The standard soak time includes a default value of 24 hours for semiconductor manufacturer's exposure time (MET) between bake and bag and includes the maximum time allowed out of the bag at the distributor's facility.

Luminous Flux Bins

Table 2:

Bin Code	Minimum Radiant Flux (Φ) @ $I_F = 700\text{mA}$ ^[1,2] (mW)	Maximum Radiant Flux (Φ) @ $I_F = 700\text{mA}$ ^[1,2] (mW)
M	900	1250
N	1250	1600
P	1600	2000
Q	2000	2400

Notes for Table 2:

1. Luminous flux performance guaranteed within published operating conditions. LedEngin maintains a tolerance of $\pm 10\%$ on flux measurements.
2. Future products will have even higher levels of luminous flux performance. Contact LedEngin Sales for updated information.

Dominant Wavelength Bins

Table 3:

Bin Code	Minimum Peak Wavelength (λ_p) @ $I_F = 700\text{mA}$ ^[1] (nm)	Maximum Peak Wavelength (λ_p) @ $I_F = 700\text{mA}$ ^[1] (nm)
U0	365	370
U1	370	375

Notes for Table 3:

1. Dominant wavelength is derived from the CIE 1931 Chromaticity Diagram and represents the perceived hue.
2. LedEngin maintains a tolerance of $\pm 0.5\text{nm}$ on dominant wavelength measurements.

Forward Voltage Bins

Table 4:

Bin Code	Minimum Forward Voltage (V_F) @ $I_F = 700\text{mA}$ ^[1,2] (V)	Maximum Forward Voltage (V_F) @ $I_F = 700\text{mA}$ ^[1,2] (V)
0	41.28	55.68

Notes for Table 4:

1. Forward Voltage is binned with all 12 LED dice connected in series.
2. LedEngin maintains a tolerance of $\pm 0.48\text{V}$ for forward voltage measurements ($\pm 0.04\text{V}$ per die).

Absolute Maximum Ratings

Table 5:

Parameter	Symbol	Value	Unit
DC Forward Current ^[1]	I_F	700	mA
Peak Pulsed Forward Current ^[2]	I_{FP}	850	mA
Reverse Voltage	V_R	See Note 3	V
Storage Temperature	T_{stg}	-40 ~ +150	°C
Junction Temperature	T_J	100	°C
Soldering Temperature ^[4]	T_{sol}	180	°C
Allowable Reflow Cycles		6	
ESD Sensitivity ^[5]		> 2,000 V HBM Class 2B JESD22-A114-D	

Notes for Table 5:

- Maximum DC forward current (per die) is determined by the overall thermal resistance and ambient temperature. Follow the curves in Figure 10 for current derating.
- Pulse forward current conditions: Pulse Width \leq 10msec and Duty Cycle \leq 10%.
- LEDs are not designed to be reverse biased.
- Solder conditions per JEDEC 020D. See Reflow Soldering Profile Figure 3.
- LedEngin recommends taking reasonable precautions towards possible ESD damages and handling the LZC-00U600 in an electrostatic protected area (EPA). An EPA may be adequately protected by ESD controls as outlined in ANSI/ESD S6.1.

Optical Characteristics @ $T_C = 25^\circ\text{C}$

Table 6:

Parameter	Symbol	Typical	Unit
Radiant Flux (@ $I_F = 700\text{mA}$) ^[1]	Φ_V	1650	mW
Peak Wavelength	λ_D	365	nm
Viewing Angle ^[2]	$2\Theta_{1/2}$	95	Degrees
Total Included Angle ^[3]	$\Theta_{0.9V}$	115	Degrees

Notes for Table 6:

- Luminous flux typical value is for all four LED dice operating concurrently at rated current.
- Viewing Angle is the off axis angle from emitter centerline where the luminous intensity is $\frac{1}{2}$ of the peak value.
- Total Included Angle is the total angle that includes 90% of the total luminous flux.

Electrical Characteristics @ $T_C = 25^\circ\text{C}$

Table 7:

Parameter	Symbol	Typical	Unit
Forward Voltage (@ $I_F = 700\text{mA}$) ^[1]	V_F	49	V
Temperature Coefficient of Forward Voltage ^[1]	$\Delta V_F / \Delta T_J$	-14.8	mV/°C
Thermal Resistance (Junction to Case)	$R\Theta_{J-C}$	0.7	°C/W

Notes for Table 7:

- Typical values for Forward Voltage and Temperature Coefficient of Forward Voltage is shown for with all 12 LED dice connected in series.

Mechanical Dimensions (mm)

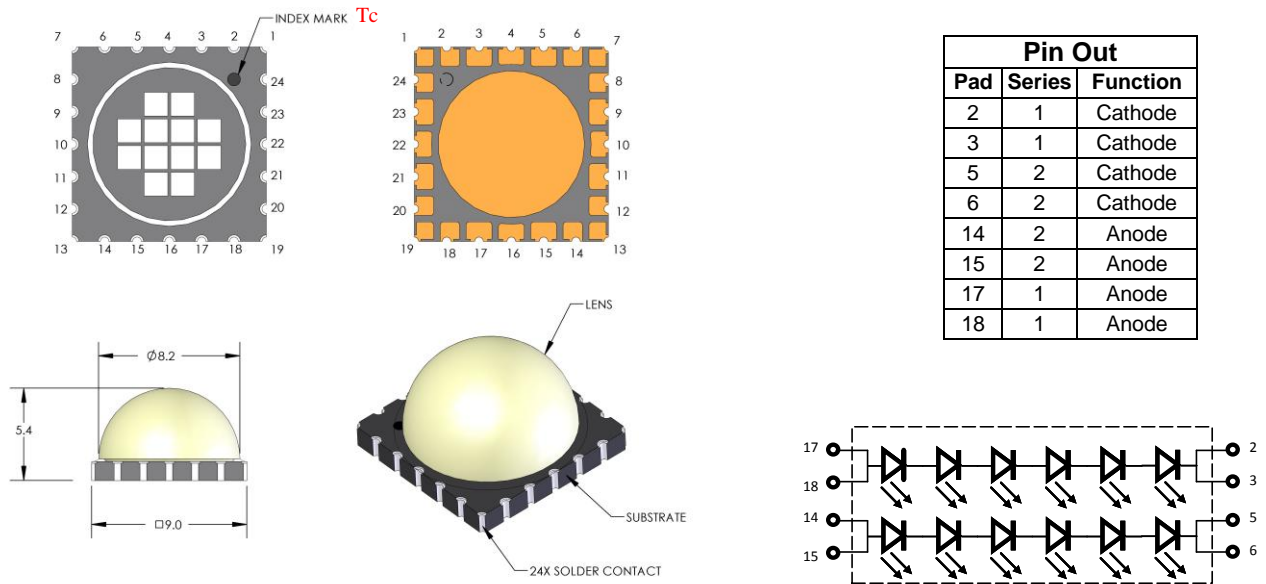

Figure 1: Package outline drawing.

Notes for Figure 1:

1. Unless otherwise noted, the tolerance = ± 0.20 mm.
2. Thermal contact, Pad is electrically neutral.

Recommended Solder Pad Layout (mm)

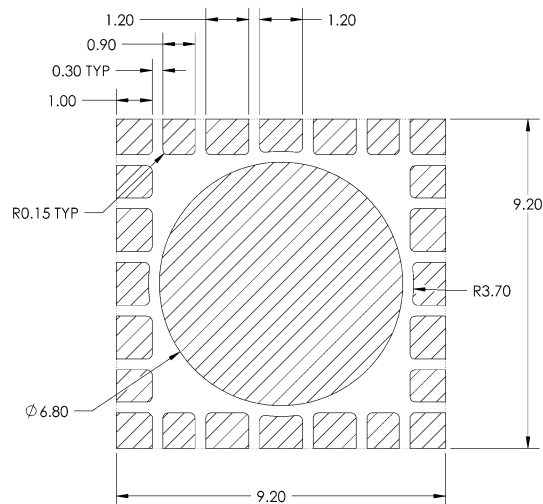

Figure 2: Recommended solder mask opening (hatched area) for anode, cathode, and thermal pad.

Note for Figure 2:

1. Unless otherwise noted, the tolerance = ± 0.20 mm.
2. Recommended stencil thickness is 125 μ m.

Reflow Soldering Profile

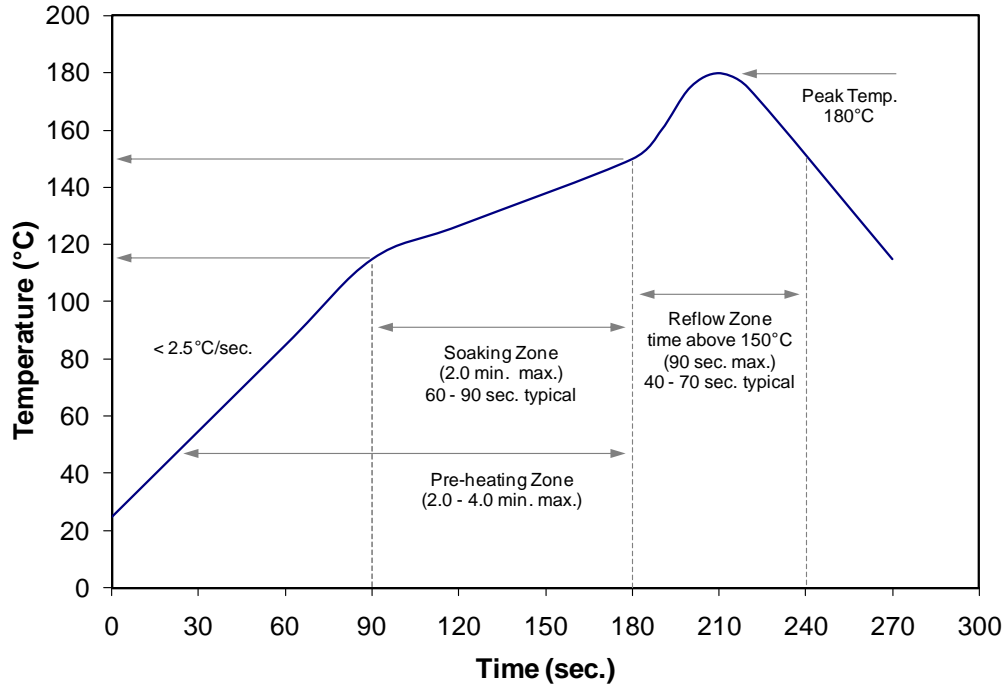

Figure 3: Reflow soldering profile for lead free soldering.

Notes for Figure 3:

1. Solder profile for low temperature solder. LedEngin recommends 58Bi-42Sn (wt.%) Solder for our low temperature solder profile.

Typical Radiation Pattern

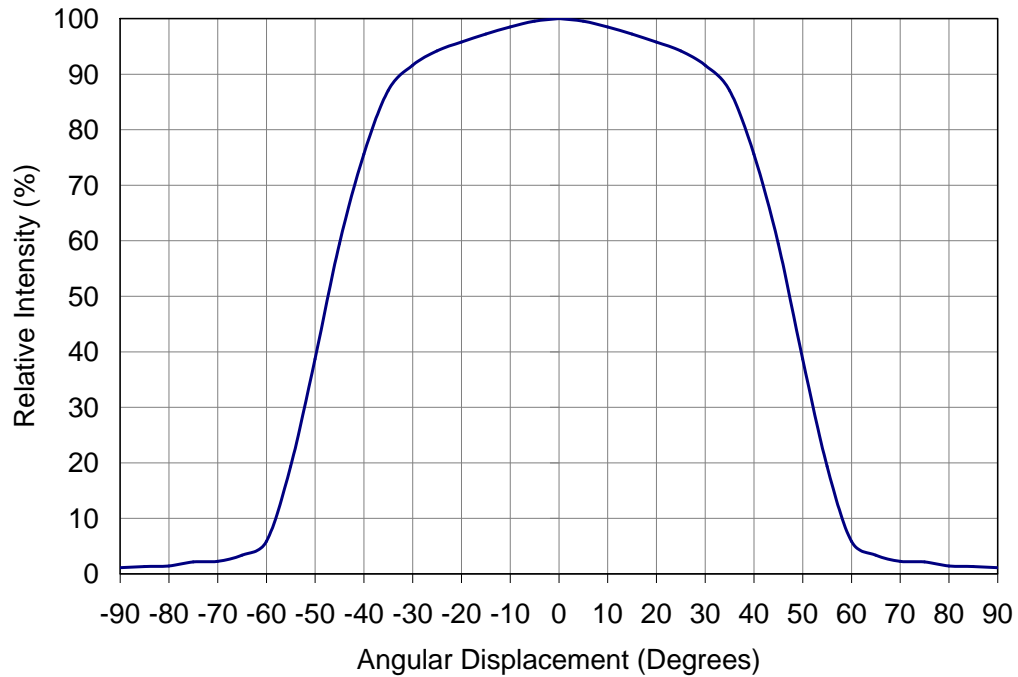

Figure 4: Typical representative spatial radiation pattern.

Typical Relative Spectral Power Distribution

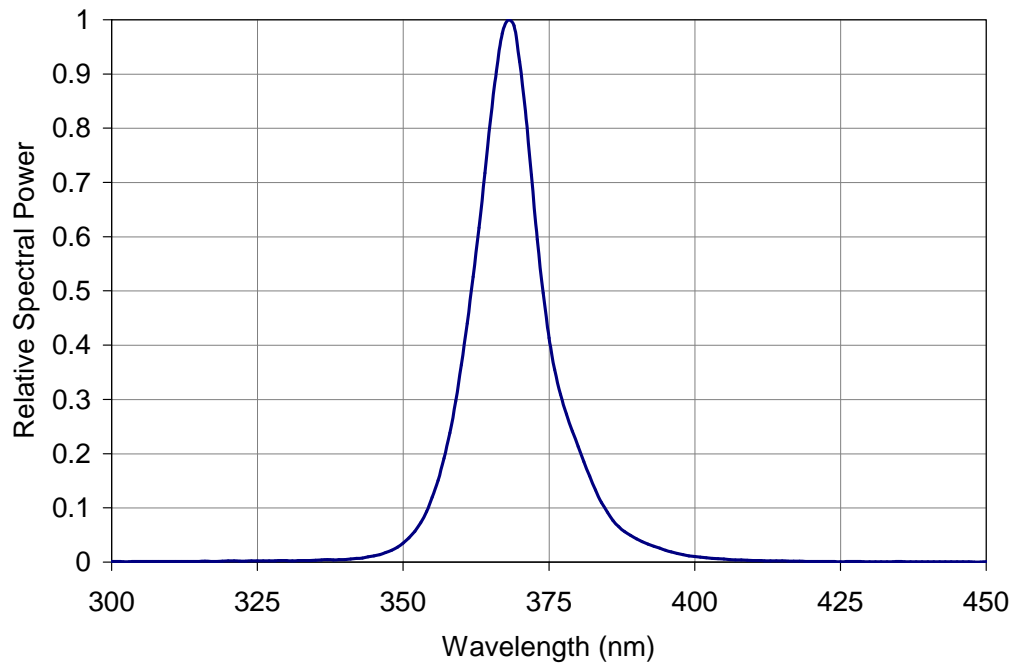

Figure 5: Relative spectral power vs. wavelength @ $T_c = 25^\circ\text{C}$.

Typical Relative Dominant Wavelength Shift over Temperature

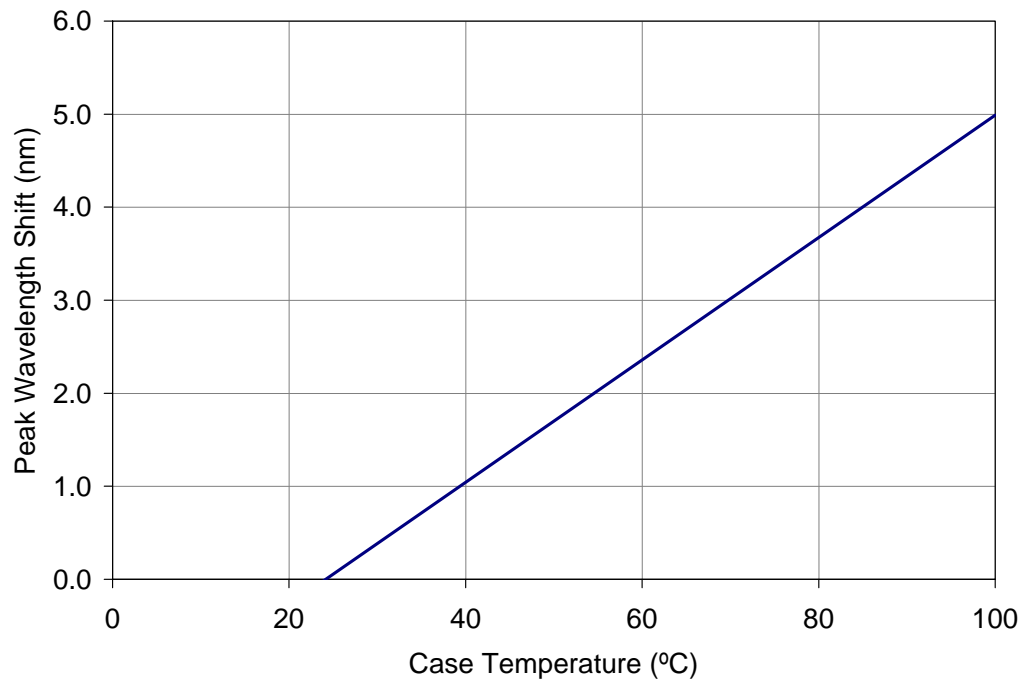

Figure 6: Typical dominant wavelength shift vs. case temperature.

Typical Relative Radiant Flux

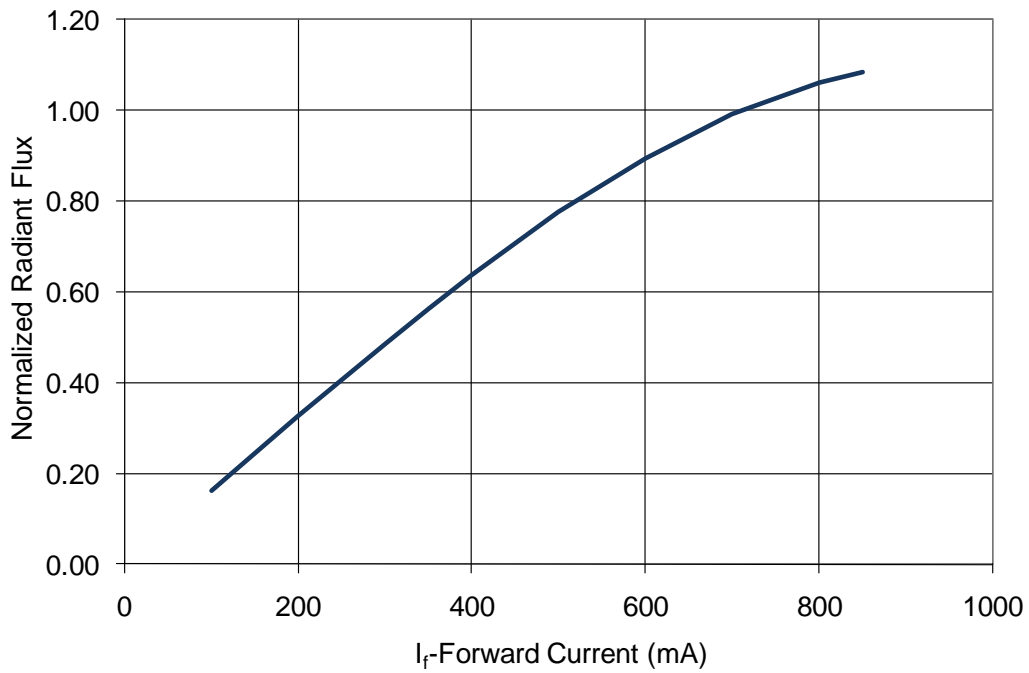

Figure 7: Typical relative Radiant Flux vs. forward current @ $T_c = 25^\circ\text{C}$.

Typical Relative Radiant Flux over Temperature

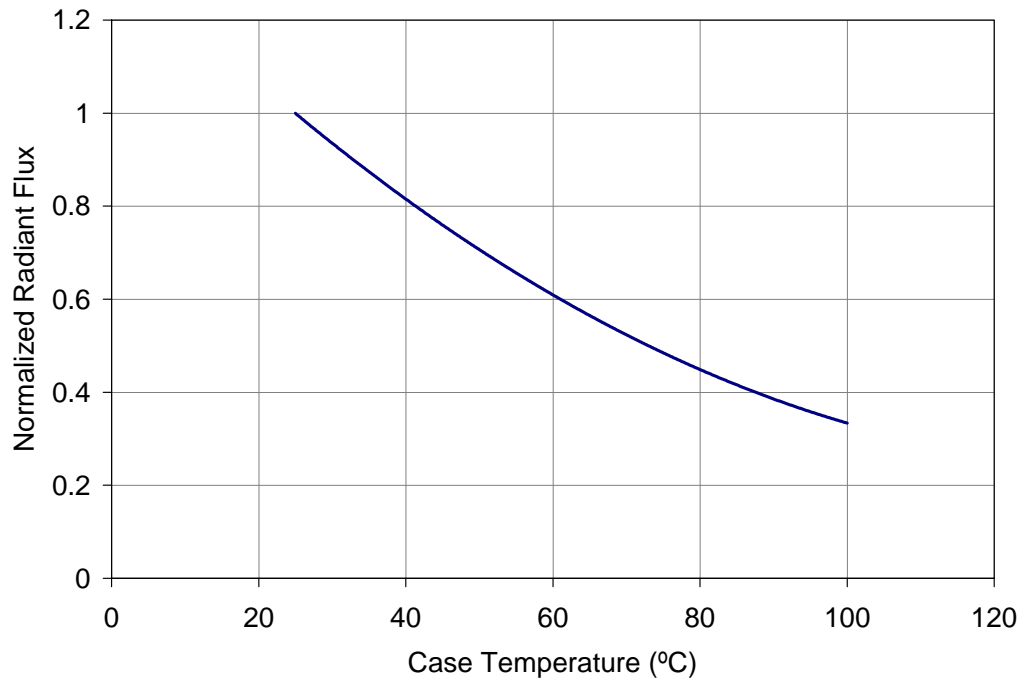

Figure 8: Typical relative Radiant Flux vs. case temperature.

Typical Forward Current Characteristics

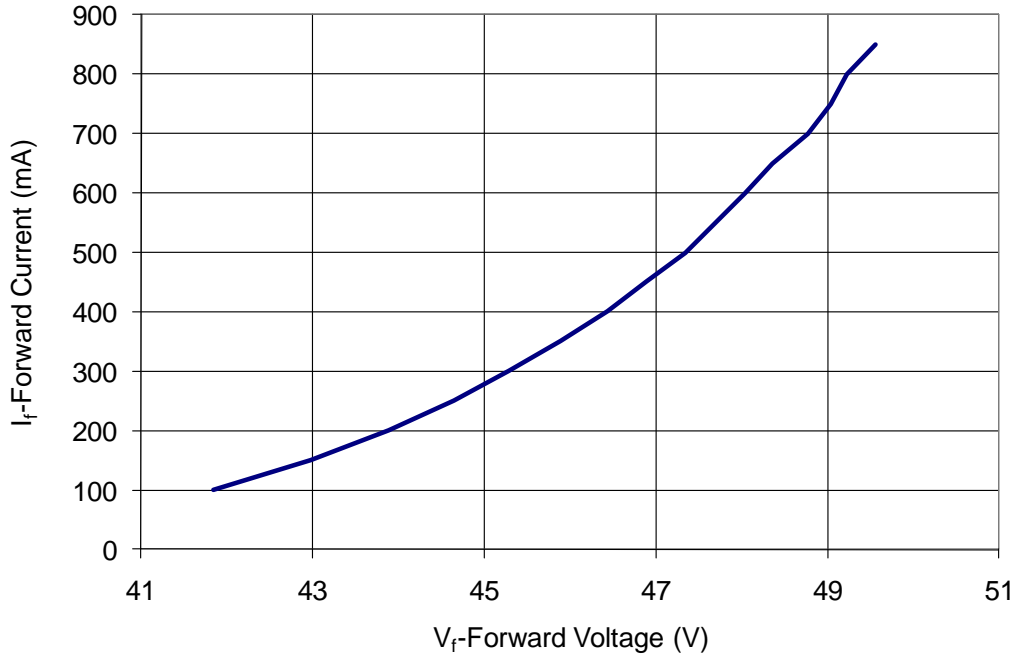

Figure 9: Typical forward current vs. forward voltage @ T_C = 25°C.

Note for Figure 9:

1. Forward Voltage curve is assumes that all twelve LED dice are connected in series.

Current De-rating

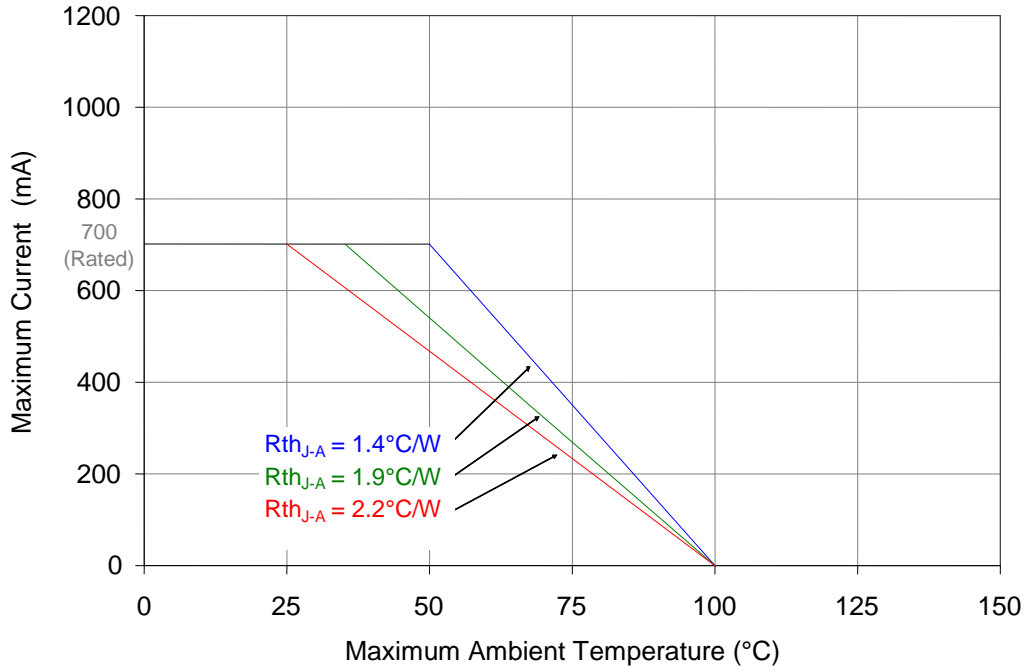

Figure 10: Maximum forward current vs. ambient temperature based on T_{J(MAX)} = 100°C.

Notes for Figure 10:

2. Maximum current assumes that all four LED dice are operating concurrently at the same current.
3. R_{ΘJ-C} [Junction to Case Thermal Resistance] for the LZC-series is typically 0.7°C/W.
4. R_{ΘJ-A} [Junction to Ambient Thermal Resistance] = R_{ΘJ-C} + R_{ΘC-A} [Case to Ambient Thermal Resistance].

Emitter Tape and Reel Specifications (mm)

TBD

Figure 12: Emitter carrier tape specifications (mm).

TBD

Figure 13: Emitter reel specifications (mm).

Notes for Figure 13:

1. Reel quantity minimum: tbd emitters. Reel quantity maximum: tbd emitters.
2. Label will provide full part number with bin code information pro unique bin combination packaging quantity
 - a. L Z A – B C D E 0 0 – H J K L (see page 3 for base part number information)
 - i. H - designate the Flux bin (see table 2)
 - ii. J & K - designate the Wavelength bin (see table 3)
 - iii. L - designate the Vf bin (see table 4)

MCPCB Option – Serial 1x12 configuration LZC-7xxx00

- Typical Thermal Resistance for MCPCB adds only 0.8°C/W
- Serial configuration allows for easy driver control with low current
- MCPCB contains Zener Diodes for enhanced ESD protection

The LZC-7xxx00 Serial MCPCB option provides a convenient method to mount LedEngin's single color LZC emitters. The six recessed features allow the use of M3 or #4 screws to attach the MCPCB to a heat sink. The MCPCB also contains Zener diodes for enhanced ESD protection.

R_{ΘJ-B} Lookup Table

Table 8:

Product	Typical Emitter R _{ΘJ-C}	+	Typical MCPCB R _{ΘC-B}	=	Typical Emitter + MCPCB R _{ΘJ-B} ^[1]
LZC-7	0.7°C/W	+	0.8°C/W	=	1.5°C/W

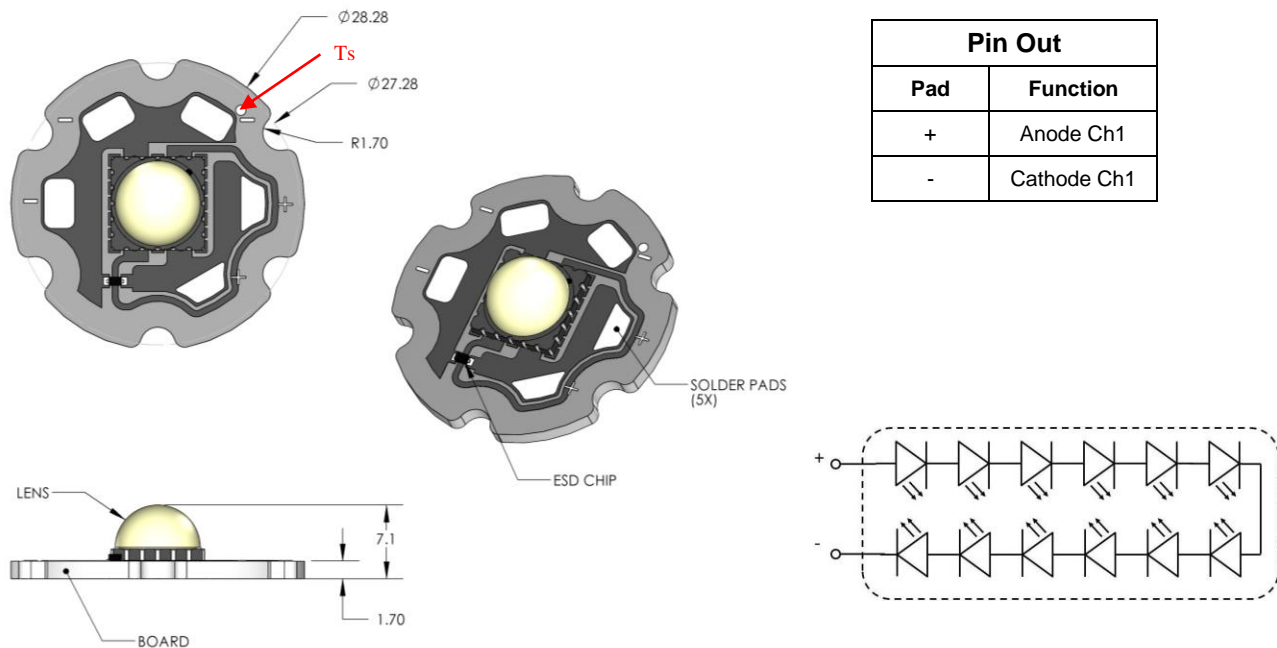

Pin Out	
Pad	Function
+	Anode Ch1
-	Cathode Ch1

Serial 1x12MCPCB outline dimensions (mm)

Notes for MCPCBs:

1. Unless otherwise noted, the tolerance = ± 0.20 mm.
2. Slots in MCPCB are for M3 or #4 mounting screws.
3. LedEngin recommends using plastic washers to electrically insulate screws from solder pads and electrical traces.
4. LedEngin recommends using thermally conductive tape or adhesives when attaching MCPCB to a heat sink.
5. Check the compatibility of the MCPCB with the emitter datasheet.

MCPCB Option – Parallel 2x6 configuration LZC-Cxxx00

- Typical Thermal Resistance for MCPCB adds only 0.8°C/W
- Parallel configuration allows for easy driver control with low Vf
- MCPCB contains Zener Diodes for enhanced ESD protection

The LZC-Cxxx00 Parallel MCPCB option provides a convenient method to mount LedEngin's single color LZC emitters. The six recessed features allow the use of M3 or #4 screws to attach the MCPCB to a heat sink. The MCPCB also contains Zener diodes for enhanced ESD protection.

R θ_{J-B} Lookup Table

Table 8:

Product	Typical Emitter R θ_{J-C}	+	Typical MCPCB R θ_{C-B}	=	Typical Emitter + MCPCB R θ_{J-B} ^[1]
LZC-C	0.7°C/W	+	0.8°C/W	=	1.5°C/W

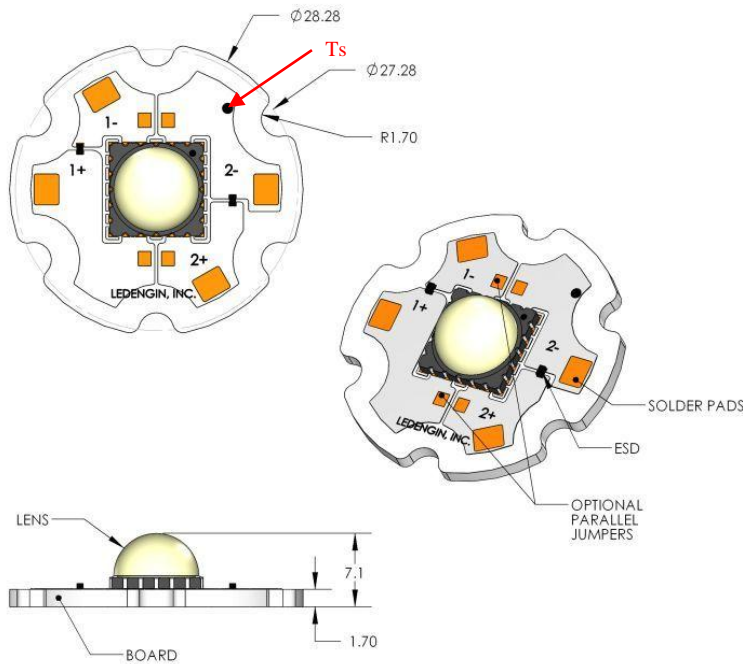

Pin Out	
Pad	Function
1+	Anode Ch1
1-	Cathode Ch1
2+	Anode Ch2
2-	Cathode Ch2

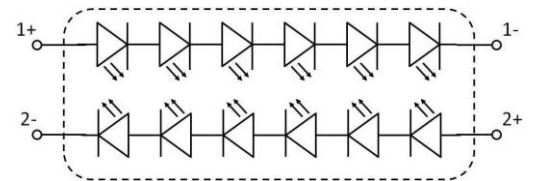

Parallel (2x6) MCPCB outline dimensions (mm)

Notes for MCPCBs:

1. Unless otherwise noted, the tolerance = ± 0.20 mm.
2. Slots in MCPCB are for M3 or #4 mounting screws.
3. LedEngin recommends using plastic washers to electrically insulate screws from solder pads and electrical traces.
4. LedEngin recommends using thermally conductive tape or adhesives when attaching MCPCB to a heat sink.
5. Check the compatibility of the MCPCB with the emitter datasheet.

Company Information

LedEngin, Inc. is a Silicon Valley based solid-state lighting company specializing in the development and manufacturing of unprecedented high-power LED emitters, modules and replacement lamps. LedEngin's packaging technologies lead the industry with products that feature lowest thermal resistance, highest flux density and consummate reliability, enabling compact and efficient solid state lighting solutions.

LedEngin's LED emitters range from 3W to 90W with ultra-compact footprints and are available in single color products including Cool White, Neutral White, Warm White, Red, Green, Blue, Amber, Deep Red, Far Red, Dental Blue and UV as well as multi-color products with RGB, RGBA and RGBW options. LedEngin's brightest White LEDs are capable of emitting 5,500 lumens.

LedEngin's robust emitters are at the core of its unique line of modules and replacement lamps producing unmatched beam quality resulting in true Lux on Target™ for a wide variety of spot and narrow flood directional lighting applications.

LedEngin is committed to providing products that conserve natural resources and reduce greenhouse emissions.

LedEngin reserves the right to make changes to improve performance without notice.

Please contact Sales@ledengin.com or (408) 492-0620 for more information.