

This hole accept a cable-tie
maximum section of 3,2x1,2mm

MARKINGS

1	Supplier identification
2	Supplier part number
3	Date MONTH/YEAR
4	Material
5	Mould identification M1 ou M2
6	Print identification (number)
7	Revision level identification

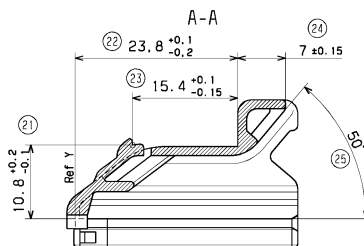
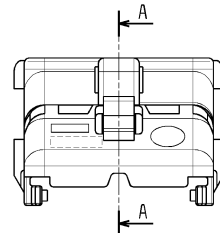
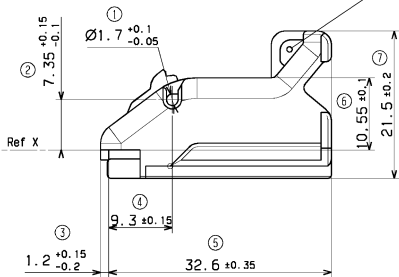
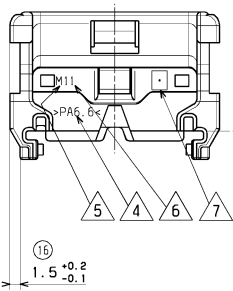

- NOTES
- 1-MATERIAL : PA 6.6 BLACK heat stabilized
 - 2-DELIVERED PRODUCT WEIGHT: 3.6 g
 - 3-RELATED COUNTERPART FEMALE CONNECTORS (32WAY)

SCALE 1:1

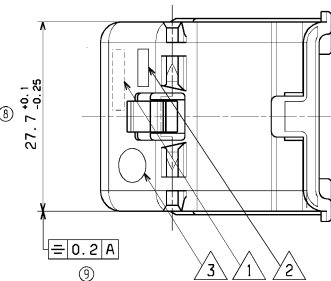
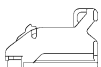

UPDATED DRAWING EC NO: 02006-0367 CD/DRWK: TBADARQX 2008/05/16 CH/AD: PGRANDCL 2008/05/16 APPR: CBOUCHAN 2008/05/16	GENERAL TOLERANCES (UNLESS SPECIFIED)		DIMENSION STYLE	SCALE	DESIGN UNITS	FIRST ANGLE PROJECTION
	4 PLACES ±	mm	INCH	MM ONLY	2.5:1	METRIC
	3 PLACES ±					
	2 PLACES ±					
	1 PLACE ±	0.1				
	ANGULAR ±	2				
DRAFT WHERE APPLICABLE MUST REMAIN WITHIN DIMENSIONS			MATERIAL NO.	DOCUMENT NO.	SHEET NO.	
			0643191201	SD-64319-002	1 OF 1	
			THIS DRAWING CONTAINS INFORMATION THAT IS PROPRIETARY TO MOLEX INCORPORATED AND SHOULD NOT BE USED WITHOUT WRITTEN PERMISSION			

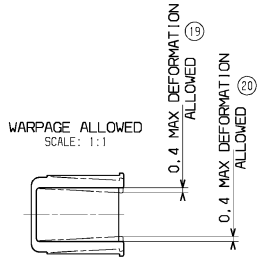
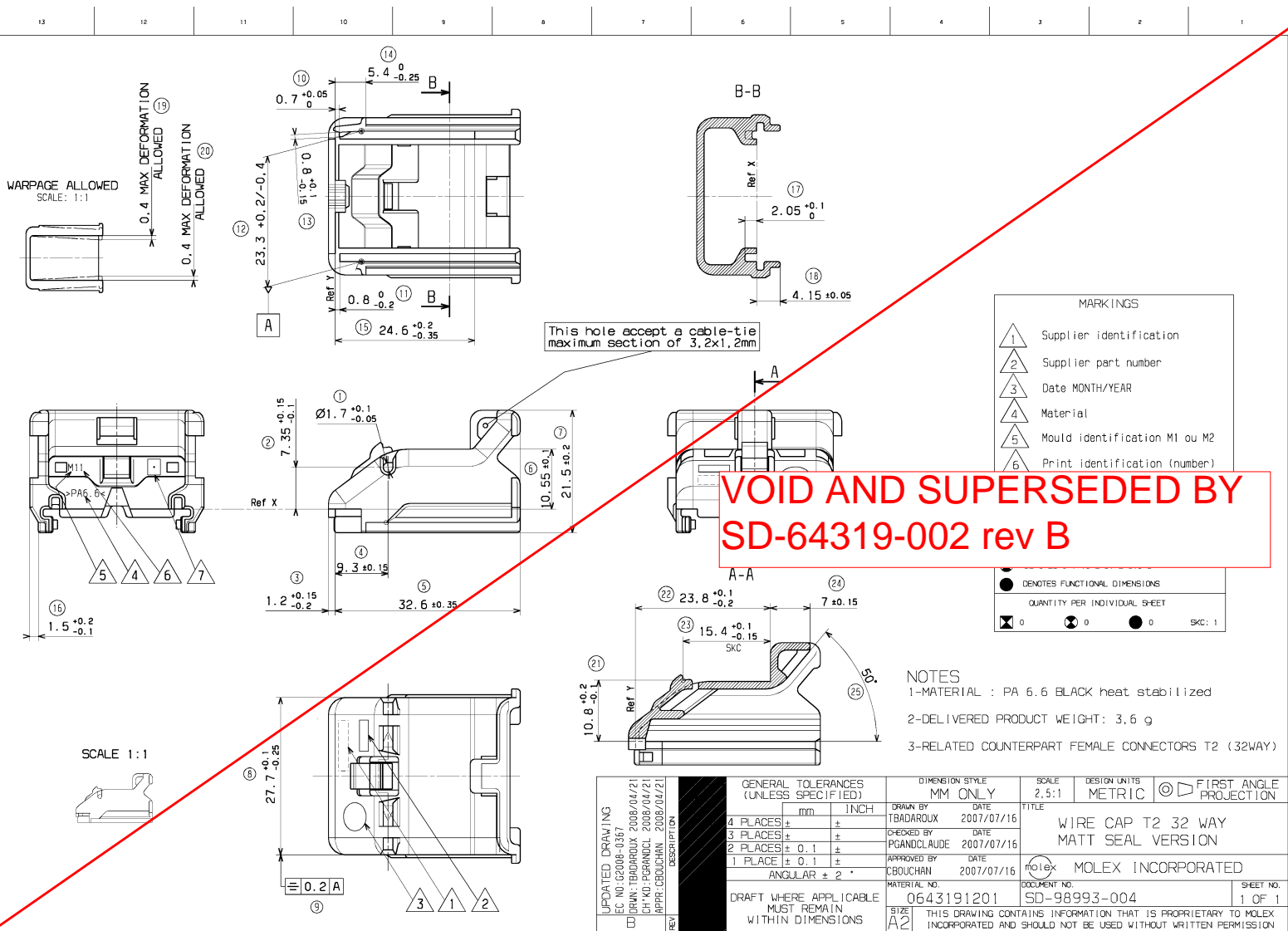

This hole accept a cable-tie
maximum section of 3,2x1,2mm

**VOID AND SUPERSEDED BY
SD-64319-002 rev B**

MARKINGS	
	Supplier identification
	Supplier part number
	Date MONTH/YEAR
	Material
	Mould identification M1 ou M2
	Print identification (number)

QUANTITY PER INDIVIDUAL SHEET			
	0		0
	0		0
	0		0
SKC: 1			

- NOTES
- 1-MATERIAL : PA 6.6 BLACK heat stabilized
 - 2-DELIVERED PRODUCT WEIGHT: 3.6 g
 - 3-RELATED COUNTERPART FEMALE CONNECTORS T2 (32WAY)

GENERAL TOLERANCES (UNLESS SPECIFIED)		DIMENSION STYLE		SCALE	DESIGN UNITS	FIRST ANGLE PROJECTION
		MM ONLY		2.5:1	METRIC	
4 PLACES	±	mm	±	DRAWN BY	DATE	TITLE
3 PLACES	±			TBADARQUX	2007/07/16	WIRE CAP T2 32 WAY
2 PLACES	±			CHECKED BY	DATE	MATT SEAL VERSION
1 PLACE	±			PGANDCLAUDE	2007/07/16	
ANGULAR ± 2 °				APPROVED BY	DATE	
				CBOUCHAN	2007/07/16	
DRAFT WHERE APPLICABLE MUST REMAIN WITHIN DIMENSIONS				MATERIAL NO.	DOCUMENT NO.	SHEET NO.
				0643191201	SD-98993-004	1 OF 1
				SIZE	THIS DRAWING CONTAINS INFORMATION THAT IS PROPRIETARY TO MOLEX INCORPORATED AND SHOULD NOT BE USED WITHOUT WRITTEN PERMISSION	
				A2		