



ATTENTION
OBSERVE PRECAUTIONS
FOR HANDLING
ELECTROSTATIC
DISCHARGE
SENSITIVE
DEVICES

Part Number: APHBM2012QBDCGKC

Blue
Green

Features

- 2.0mmx1.25mm SMT LED, 0.45mm max. thickness.
- Bi-color, low power consumption.
- Wide viewing angle.
- Ideal for backlight and indicator.
- Package : 2000pcs / reel.
- Moisture sensitivity level : level 3.
- RoHS compliant.

Description

The Blue source color devices are made with InGaN Light Emitting Diode.

The Green source color devices are made with AlGaInP on GaAs substrate Light Emitting Diode.

Static electricity and surge damage the LEDs.

It is recommended to use a wrist band or anti-electrostatic glove when handling the LEDs.

All devices, equipment and machinery must be electrically grounded.

Package Dimensions

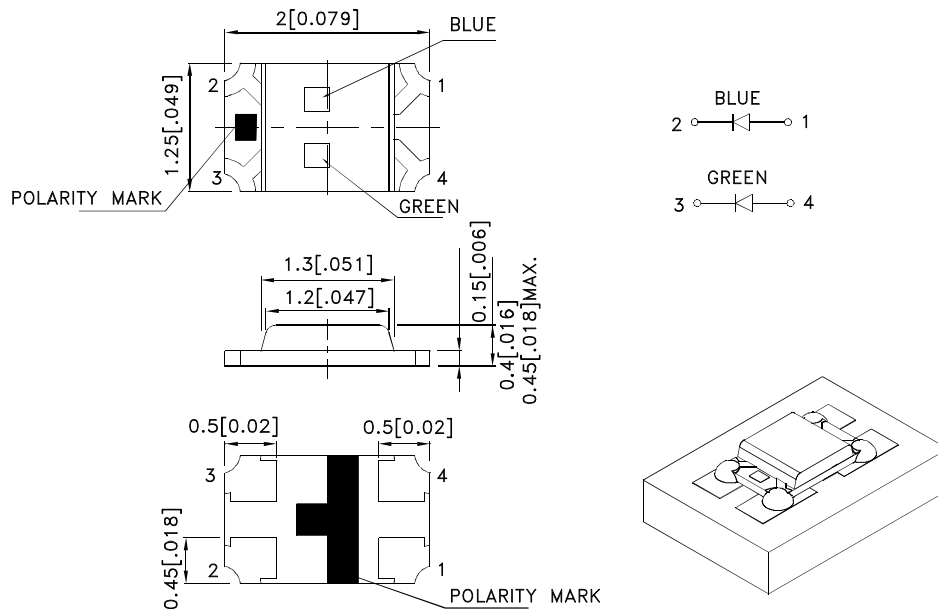

Notes:

1. All dimensions are in millimeters (inches).
2. Tolerance is ± 0.1 (0.004") unless otherwise noted.
3. The specifications, characteristics and technical data described in the datasheet are subject to change without prior notice.
4. The device has a single mounting surface. The device must be mounted according to the specifications.



Selection Guide

| Part No. | Dice | Lens Type | Iv (mcd) [2] @ 20mA | | Viewing Angle [1] |
|------------------|-----------------|-------------|------------------------|------|----------------------|
| | | | Min. | Typ. | 2θ1/2 |
| APHBM2012QBDCGKC | Blue (InGaN) | Water Clear | 50 | 80 | 120° |
| | Green (AlGaInP) | | 30 | 55 | |

Notes:

1. θ1/2 is the angle from optical centerline where the luminous intensity is 1/2 of the optical peak value.
2. Luminous intensity/ luminous Flux: +/-15%.

Electrical / Optical Characteristics at TA=25°C

| Symbol | Parameter | Device | Typ. | Max. | Units | Test Conditions |
|--------|--------------------------|---------------|------------|----------|-------|-----------------|
| λpeak | Peak Wavelength | Blue Green | 468 574 | | nm | IF=20mA |
| λD [1] | Dominant Wavelength | Blue Green | 470 570 | | nm | IF=20mA |
| Δλ1/2 | Spectral Line Half-width | Blue Green | 25 20 | | nm | IF=20mA |
| C | Capacitance | Blue Green | 100 15 | | pF | VF=0V;f=1MHz |
| VF [2] | Forward Voltage | Blue Green | 3.3 2.1 | 4 2.5 | V | IF=20mA |
| IR | Reverse Current | Blue Green | | 50 10 | uA | VR = 5V |

Notes:

1. Wavelength: +/-1nm.
2. Forward Voltage: +/-0.1V.

Absolute Maximum Ratings at TA=25°C

| Parameter | Blue | Green | Units |
|--------------------------|----------------|-------|-------|
| Power dissipation | 120 | 75 | mW |
| DC Forward Current | 30 | 30 | mA |
| Peak Forward Current [1] | 150 | 150 | mA |
| Reverse Voltage | 5 | | V |
| Operating Temperature | -40°C To +85°C | | |
| Storage Temperature | -40°C To +85°C | | |

Note:

1. 1/10 Duty Cycle, 0.1ms Pulse Width.

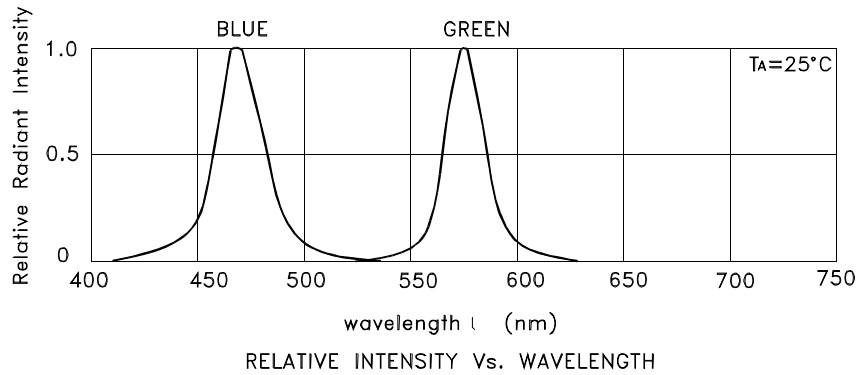

APHBM2012QBDCGKC Blue

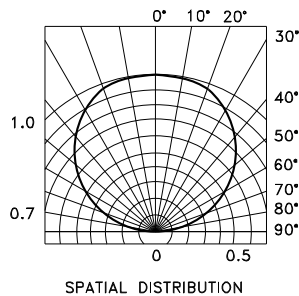
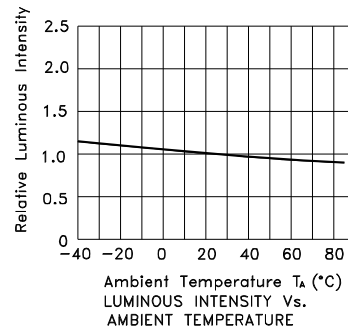
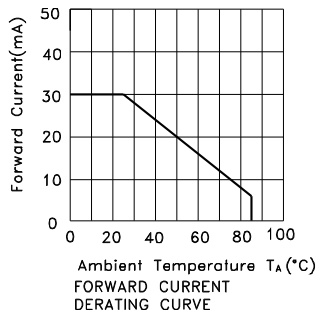
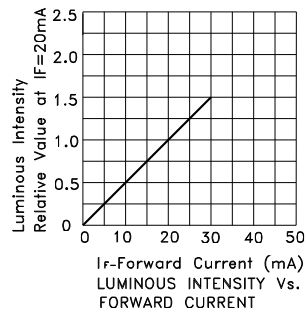
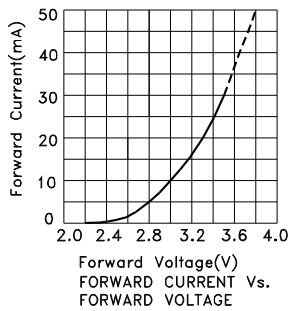

Green

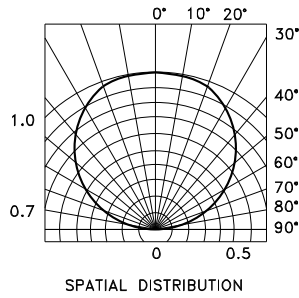
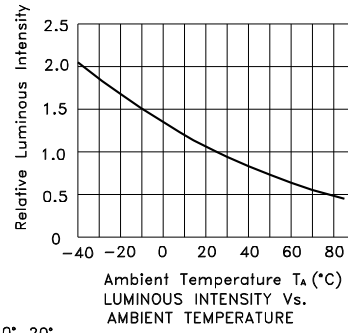
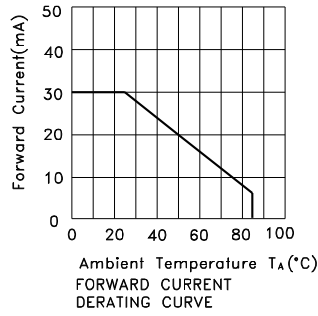
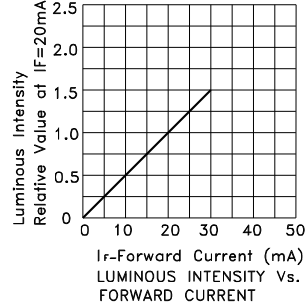
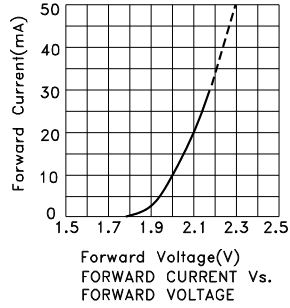

APHBM2012QBDCGKC

Reflow soldering is recommended and the soldering profile is shown below.
Other soldering methods are not recommended as they might cause damage to the product.

Reflow Soldering Profile For Lead-free SMT Process.

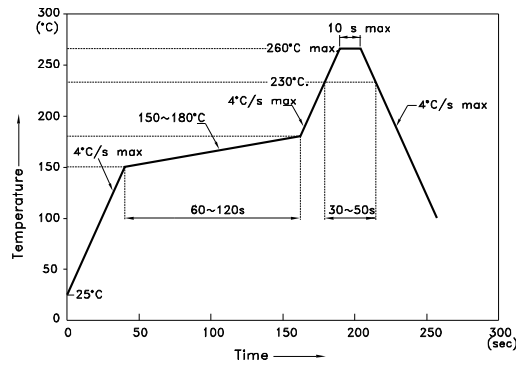

NOTES:

1. We recommend the reflow temperature 245°C(+/-5°C). The maximum soldering temperature should be limited to 260°C.
2. Don't cause stress to the epoxy resin while it is exposed to high temperature.
3. Number of reflow process shall be 2 times or less.

Recommended Soldering Pattern (Units : mm; Tolerance: ± 0.1)

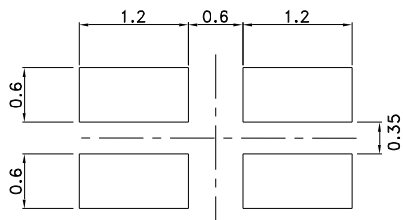

Reel Dimension

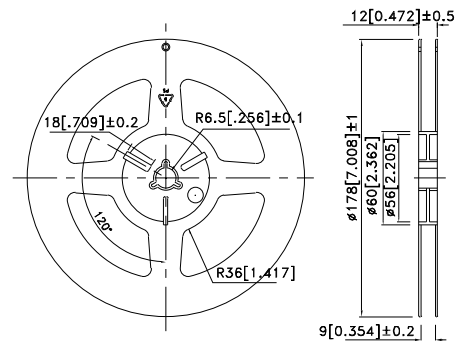

Tape Dimensions (Units : mm)

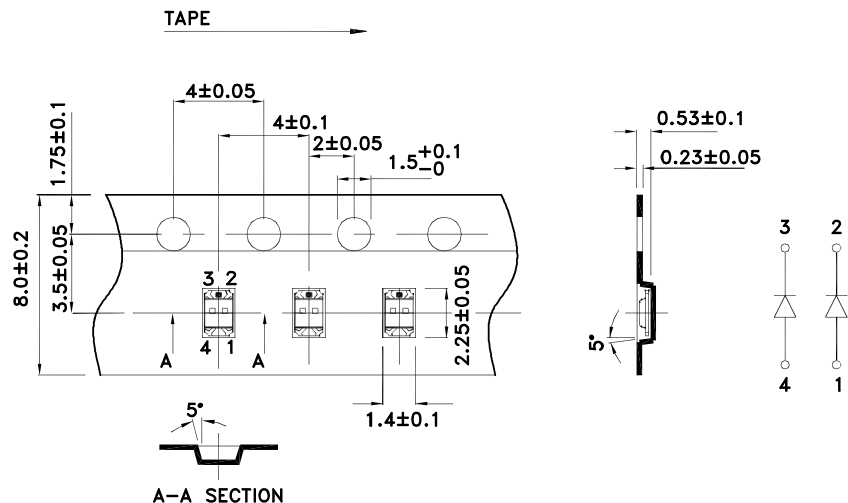

Kingbright

PACKING & LABEL SPECIFICATIONS

APHBM2012QBDCGKC

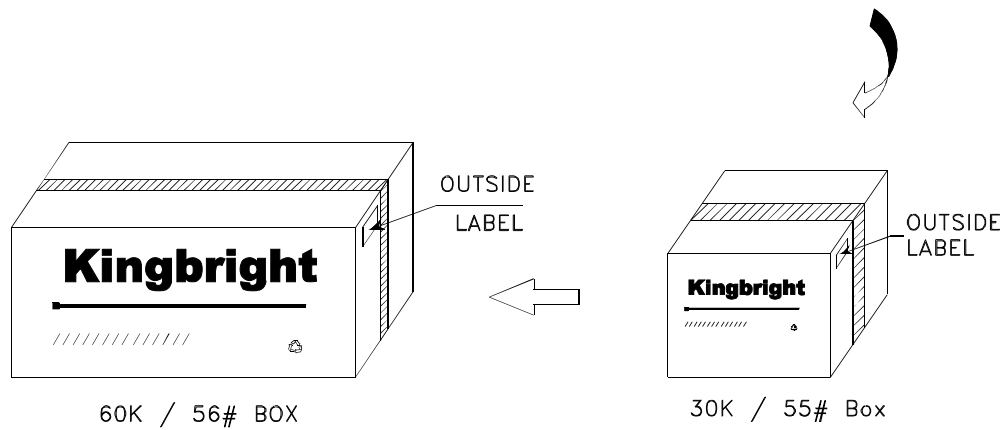
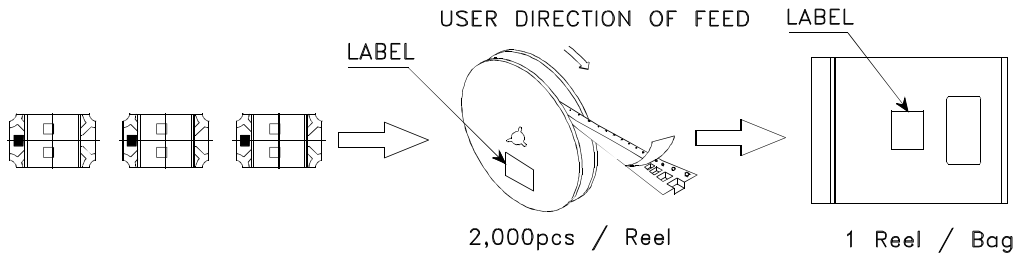

| | |
|--|--|
| Kingbright | |
| P/NO: APHBM2012xxx | |
| QTY: 2,000 pcs | Q.C. Q C xx xx xxxx PASSED |
| S/N: XXXX | |
| CODE: XXX | |
| LOT NO: | |
|  xxxxxxxxxxxxxxxxxxxxxxxx | |
| RoHS Compliant | |