

ITEM	Q'TY	PART NUMBER	PART DESCRIPTION
1	1	LPR3-XXX-XXX	Surface Mount Right Angle Light Pipe, 2.8mm, 3 Station. See Table on 2nd Page
2	1	RLPH3-XXX	LPR Housing, 3 Station, White. See Table on 2nd Page

REV.	DESCRIPTION	DATE	APPROVED
A	Engineering Release	11/06/09	T. Y.
B	Added Overall Height "K" Dim	03/04/11	T. Y.

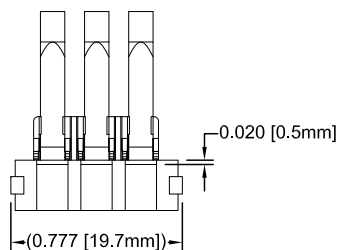

STANDARD TOLERANCE (UNLESS OTHERWISE SPECIFIED)	
DECIMALS	ANGULAR
.X ±.1	X° ± 1°
.XX ±.01	
.XXX ±.010	

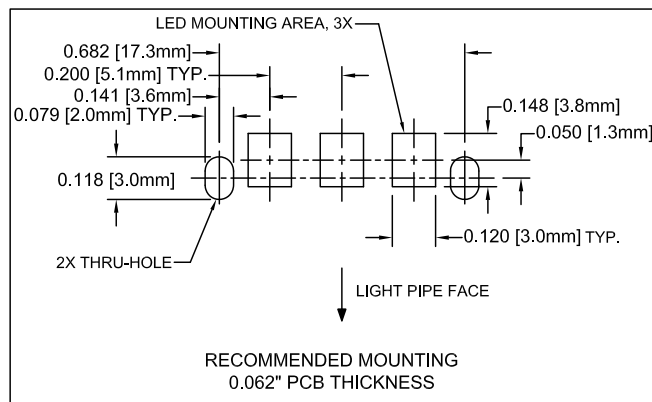
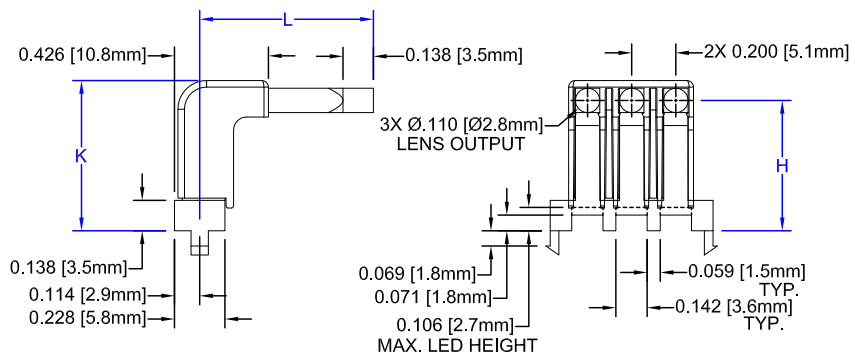
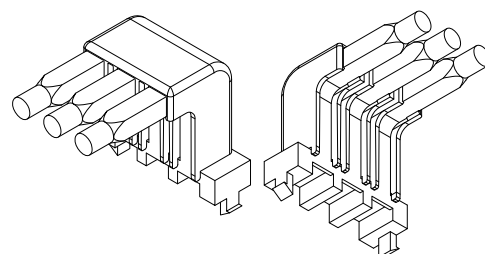
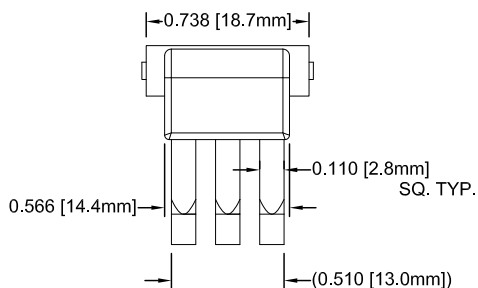







BIVAR[®]



4 THOMAS, IRVINE, CA, 92618
TEL: (949) 951-8808 FAX: (949) 951-3974

DESIGNED: Raffy Paje	DATE: 11/06/09
CHECKED: T. Yin	DATE: 11/06/09

TITLE: RIGHT ANGLE LIGHT PIPE, 2.8MM, 3 STATION		REVISION: B
PART NO: RLP3-XXX-XXX	CAGE CODE : 32559 SHEET # 1 OF 2	
CAD GENERATED DOCUMENT, DO NOT MEASURE DRAWING.		

REV.	DESCRIPTION	DATE	APPROVED
	SEE SHEET #1		

RLP3-XXX-XXX						
ASSY P/N	H	L	K	LPR3-XXX-XXX	RLPH3-XXX	FIGURE
RLP3-200-500	0.197 [5.0mm]	0.551 [14.0mm]	0.287 [7.3mm]	LPR3-200-500	RLPH3-200	
RLP3-200-650		0.669 [17.0mm]		LPR3-200-650	RLPH3-200	
RLP3-200-800		0.787 [20.0mm]		LPR3-200-800	RLPH3-200	
RLP3-400-500	0.394 [10.0mm]	0.551 [14.0mm]	0.484 [12.3mm]	LPR3-400-500	RLPH3-400	
RLP3-400-650		0.669 [17.0mm]		LPR3-400-650	RLPH3-400	
RLP3-400-800		0.787 [20.0mm]		LPR3-400-800	RPH3-400	
RLP3-600-500	0.591 [15.0mm]	0.551 [14.0mm]	0.681 [17.3mm]	LPR3-600-500	RLPH3-600	
RLP3-600-650		0.669 [17.0mm]		LPR3-600-650	RLPH3-600	
RLP3-600-800		0.787 [20.0mm]		LPR3-600-800	RLPH3-600	

STANDARD TOLERANCE (UNLESS OTHERWISE SPECIFIED)		 4 THOMAS, IRVINE, CA, 92618 TEL: (949) 951-8808 FAX: (949) 951-3974	
DECIMALS	ANGULAR		
.X ± .1	X° ± 1°	 TITLE: RIGHT ANGLE LIGHT PIPE, 2.8MM, 3 STATION	
.XX ± .01			
.XXX ± .010		PART NO: RLP3-XXX-XXX	
DESIGNED: Raffy Paje	DATE: 11/06/09	REVISION: B	
CHECKED: T. Yin	DATE: 11/06/09	CAGE CODE : 32559 SHEET # 2 OF 2	
CAD GENERATED DOCUMENT, DO NOT MEASURE DRAWING.			