

ITEM	QTY	PART NUMBER	PART DESCRIPTION
1	1	PM3	LED Holder, Panel Mount, Press Fit, (3mm)
2	1	3XXX	T-1 (3mm) Non-Flange, See Pages 2-5.

REV.	DESCRIPTION	DATE	APPROVED
A	Engineering Release	09/15/06	M. C.

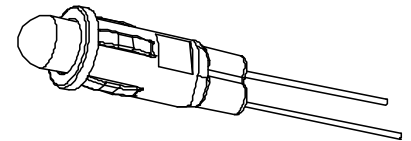
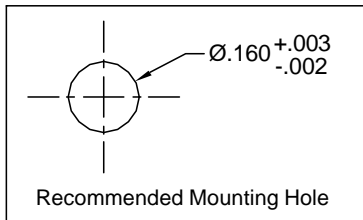
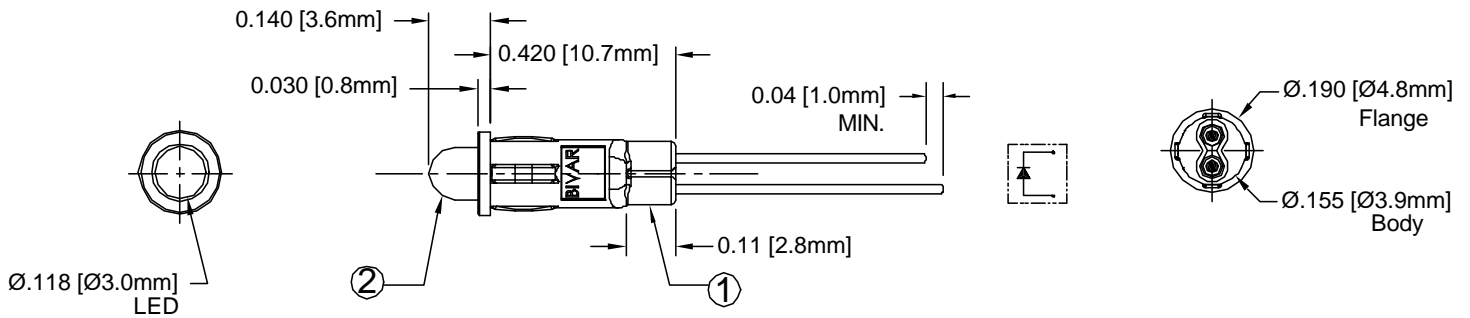

### ABSOLUTE MAXIMUM RATINGS ( $T_a = 25^\circ\text{C}$ )

REVERSE VOLTAGE	_____	5V
REVERSE CURRENT ( $V_R=5V$ )	_____	100 $\mu$ A
OPERATING TEMPERATURE RANGE	_____	-25 $^\circ\text{C}$ ~ 85 $^\circ\text{C}$
STORAGE TEMPERATURE	_____	-30 $^\circ\text{C}$ ~ 100 $^\circ\text{C}$
LEAD SOLDERING TEMPERATURE (1/16" FROM BODY)	_____	260 $^\circ\text{C}$ for 5 Seconds

STANDARD TOLERANCE ( UNLESS OTHERWISE SPECIFIED )		 4 THOMAS, IRVINE, CA. 92618 TEL: (949) 951-8808 FAX: (949) 951-3974	
DECIMALS	ANGULAR		
.X $\pm .1$	X $^\circ$ $\pm 1^\circ$		
.XX $\pm .02$		<b>TITLE:</b> T-1 (3mm) PANEL MOUNT ASSEMBLY	REVISION:
.XXX $\pm .010$			DESIGNED: <b>Dan Beckman</b>
		<b>PART NO:</b> PM3XXX	
		<b>CAGE CODE :</b> 32559   <b>SHEET #</b> 1 OF 5	
		CAD GENERATED DOCUMENT. DO NOT MEASURE DRAWING.	

REV.	DESCRIPTION	DATE	APPROVED
	SEE SHEET#1.		

LED Part No.	Chip			Lens Appearance	Absolute Max. Ratings				Electro-Optical Data @ 20ma			Viewing Angle 2 Θ ½ (Deg)
	Material	Peak Wave Length λp(nm)	Emitted Color		Δλ (nm)	Pd (mW)	If (mA)	Peak If(mA)	Vf (V)		Iv (mcd)	
									TYP	MAX	TYP	
3BWC	GaN/SiC	430	BLUE	WATER CLEAR	65	150	25	70	4.0	4.5	50	30
3BWD	GaN/SiC	430	BLUE	DIFFUSED	65	150	25	70	4.0	4.5	20	45
3BWT	GaN/SiC	430	BLUE	TINTED	65	150	25	70	4.0	4.5	50	30
3PGC	GaP/GaP	555	PURE GREEN	WATER CLEAR	25	80	30	150	2.2	2.6	12	30
3PGD	GaP/GaP	555	PURE GREEN	DIFFUSED	25	80	30	150	2.2	2.6	5	45
3PGT	GaP/GaP	555	PURE GREEN	TINTED	25	80	30	150	2.2	2.6	12	30
3GC	GaP/GaP	565	GREEN	WATER CLEAR	30	80	30	150	2.2	2.6	65	30
3GD	GaP/GaP	565	GREEN	DIFFUSED	30	80	30	150	2.2	2.6	30	45
3GT	GaP/GaP	565	GREEN	TINTED	30	80	30	150	2.2	2.6	65	30
3YC	GaAsP/GaP	585	YELLOW	WATER CLEAR	35	80	30	150	2.1	2.6	55	30
3YD	GaAsP/GaP	585	YELLOW	DIFFUSED	35	80	30	150	2.1	2.6	20	45
3YT	GaAsP/GaP	585	YELLOW	TINTED	35	80	30	150	2.1	2.6	55	30
3AC	GaAsP/GaP	610	AMBER	WATER CLEAR	35	80	30	150	2.2	2.6	65	30
3AD	GaAsP/GaP	610	AMBER	DIFFUSED	35	80	30	150	2.2	2.6	30	45
3AT	GaAsP/GaP	610	AMBER	TINTED	35	80	30	150	2.2	2.6	65	30
3HC	GaAsP/GaP	635	HE RED	WATER CLEAR	45	80	30	150	2.0	2.6	100	30
3HD	GaAsP/GaP	635	HE RED	DIFFUSED	45	80	30	150	2.0	2.6	30	45
3HT	GaAsP/GaP	635	HE RED	TINTED	45	80	30	150	2.0	2.6	100	30
3RC	GaAsP/GaAs	655	RED	WATER CLEAR	40	80	40	200	1.7	2.0	18	30
3RD	GaAsP/GaAs	655	RED	DIFFUSED	40	80	40	200	1.7	2.0	6	45
3RT	GaAsP/GaAs	655	RED	TINTED	40	80	40	200	1.7	2.0	18	30

STANDARD TOLERANCE ( UNLESS OTHERWISE SPECIFIED ) ±10 % ALL VALUES		ANGULAR X° ± 5°		 <b>BIVAR</b> <sup>®</sup> 4 THOMAS, IRVINE, CA. 92618 TEL: (949) 951-8808 FAX: (949) 951-3974	
DESIGNED: <b>Dan Beckman</b>		DATE: <b>09/15/06</b>			
CHECKED: <b>T. Yin</b>		DATE: <b>09/15/06</b>		PART NO: <b>PM3XXX</b>	
				CAGE CODE : <b>32559</b> SHEET # <b>2 OF 5</b>	
CAD GENERATED DOCUMENT. DO NOT MEASURE DRAWING.					

REV.	DESCRIPTION	DATE	APPROVED
	SEE SHEET#1.		

LED Part No.	Chip			Lens Appearance	Absolute Max. Ratings				Electro-Optical Data @ 20ma			Viewing Angle 2θ ½ (Deg)
	Material	Peak Wave Length λp(nm)	Emitted Color		Δλ (nm)	Pd (mW)	If (mA)	Peak If(mA)	Vf (V)		Iv (mcd)	
									TYP	MAX	TYP	
3SGC	GaP/GaP	568	SUPER GREEN	WATER CLEAR	30	80	30	150	2.2	2.6	120	30
3SGD	GaP/GaP	568	SUPER GREEN	DIFFUSED	30	80	30	150	2.2	2.6	55	45
3SGT	GaP/GaP	568	SUPER GREEN	TINTED	30	80	30	150	2.2	2.6	120	30
3SYC	GaAsP/GaP	585	SUPER YELLOW	WATER CLEAR	35	80	30	150	2.1	2.6	65	30
3SYD	GaAsP/GaP	585	SUPER YELLOW	DIFFUSED	35	80	30	150	2.1	2.6	30	45
3SYT	GaAsP/GaP	585	SUPER YELLOW	TINTED	35	80	30	150	2.1	2.6	25	30
3SAC	AlGaInP	620	SUPER AMBER	WATER CLEAR	17	100	30	150	2.0	2.6	350	30
3SAD	AlGaInP	620	SUPER AMBER	DIFFUSED	17	100	30	150	2.0	2.6	150	45
3SAT	AlGaInP	620	SUPER AMBER	TINTED	17	100	30	150	2.0	2.6	350	30
3SRC	GaAiAsP/GaAs	660	SUPER RED	WATER CLEAR	20	80	20	150	1.7	2.6	250	30
3SRD	GaAiAsP/GaAs	660	SUPER RED	DIFFUSED	20	80	20	150	1.7	2.6	90	45
3SRT	GaAiAsP/GaAs	660	SUPER RED	TINTED	20	80	20	150	1.7	2.6	250	30

STANDARD TOLERANCE ( UNLESS OTHERWISE SPECIFIED ) ±10 % ALL VALUES		ANGULAR X° ± 5°		 <b>BIVAR</b> <sup>®</sup> 4 THOMAS, IRVINE, CA. 92618 TEL: (949) 951-8808 FAX: (949) 951-3974	
DESIGNED: <b>Dan Beckman</b>		DATE: <b>09/15/06</b>			
CHECKED: <b>T. Yin</b>		DATE: <b>09/15/06</b>		TITLE: T-1 (3mm) PANEL MOUNT ASSEMBLY PART NO: <b>PM3XXX</b> REVISION: <b>A</b>	
				CAGE CODE : <b>32559</b> SHEET # <b>3 OF 5</b>	
CAD GENERATED DOCUMENT. DO NOT MEASURE DRAWING.					



REV.	DESCRIPTION	DATE	APPROVED
	SEE SHEET#1.		

LED Part No.	Chip			Lens Appearance	Absolute Max. Ratings				Electro-Optical Data @ 20mA			Viewing Angle $2\theta_{1/2}$ (Deg)
	Material	Peak Wave Length $\lambda_p$ (nm)	Emitted Color		$\Delta\lambda$ (nm)	Pd (mW)	If (mA)	Peak If (mA)	Vf (V)		Iv (mcd)	
									Typ.	Max.	Typ.	
3UBWC-0.6K	InGaN/SiC	466	BLUE	WATER CLEAR	26	76	50	150	3.5	4.5	600	20
3UTC	InGaN/SiC	502	TURQUOISE	WATER CLEAR	30	70	30	150	3.5	4.5	900	20
3UGC	InGaAlP	563	GREEN	WATER CLEAR	11	100	30	150	2.2	2.6	800	30
3SUGC	InGaAlP	574	GREEN	WATER CLEAR	22	100	30	150	2.2	3.0	1000	30
3UYC	InGaAlP	588	YELLOW	WATER CLEAR	15	100	30	150	2.0	2.6	600	20
3SUYC	InGaAlP	592	YELLOW	WATER CLEAR	15	100	30	150	2.0	2.6	1000	30
3UUYC	InGaAlP	592	YELLOW	WATER CLEAR	15	100	30	150	2.1	2.6	2000	30
3UOC	AlGaInP	620	ORANGE	WATER CLEAR	17	100	30	150	2.2	2.6	1500	30
3SUOC	InGaAlP	633	ORANGE	WATER CLEAR	17	100	30	150	2.2	2.6	2200	30
3URC	GaAlAs/GaAs	660	RED	WATER CLEAR	20	60	30	150	1.7	2.6	400	30
3SURC	GaAlAs/GaAs	660	RED	WATER CLEAR	20	65	30	150	2.0	2.6	600	30
3UWC-0.6K	InGaN/SiC	X=.30 Y=.31	WHITE	WATER CLEAR	-	120	30	100	3.5	4.0	1500	30

STANDARD TOLERANCE ( UNLESS OTHERWISE SPECIFIED ) ±10 % ALL VALUES		ANGULAR X° ± 5°		 <b>BIVAR</b> <sup>®</sup> 4 THOMAS, IRVINE, CA. 92618 TEL: (949) 951-8808 FAX: (949) 951-3974	
DESIGNED: <b>Dan Beckman</b>		DATE: <b>09/15/06</b>			
CHECKED: <b>T. Yin</b>		DATE: <b>09/15/06</b>		PART NO: <b>PM3XXX</b>	
				CAGE CODE : <b>32559</b>   SHEET # <b>4 OF 5</b>	
CAD GENERATED DOCUMENT. DO NOT MEASURE DRAWING.					

REV.	DESCRIPTION	DATE	APPROVED
	SEE SHEET#1.		

LED Part No.	Chip			Lens Appearance	Absolute Max. Ratings			Electro-Optical Data @ 2mA			Viewing Angle $2\theta_{1/2}$ (Deg)
	Material	Peak Wave Length $\lambda_p$ (nm)	Emitted Color		$\Delta\lambda$ (nm)	Pd (mW)	If (mA)	Vf (V)		Iv (mcd)	
								TYP	MAX	TYP	
3BVDL	GaN/SiC	430	BLUE	DIFFUSED	65	10	5	3.5	4.0	6	45
3GDL	GaP/GaP	565	GREEN	DIFFUSED	30	10	5	1.9	2.2	6	45
3PGDL	GaP/GaP	585	PURE GREEN	DIFFUSED	25	10	5	1.9	2.2	4	45
3YDL	GaAsP/GaP	585	YELLOW	DIFFUSED	35	10	5	1.9	2.2	4	45
3ADL	GaAsP/GaP	610	AMBER	DIFFUSED	35	10	5	1.9	2.2	6	45
3HDL	GaAsP/GaP	635	HE RED	DIFFUSED	45	10	5	1.8	2.2	6	45
3RDL	GaAsP/GaAs	655	RED	DIFFUSED	40	10	5	1.9	2.2	1	45
3SRDL	GaAlAs/GaAs	660	SUPER RED	DIFFUSED	20	10	5	1.6	2.0	14	45

STANDARD TOLERANCE ( UNLESS OTHERWISE SPECIFIED ) <small>±10 % ALL VALUES</small>		 <b>BIVAR</b> <sup>®</sup> 4 THOMAS, IRVINE, CA. 92618 TEL: (949) 951-8808 FAX: (949) 951-3974	
<small>ANGULAR</small> $X^\circ \pm 5^\circ$			
DESIGNED: <b>Dan Beckman</b>	DATE: <b>09/15/06</b>	<b>TITLE:</b> T-1 (3mm) PANEL MOUNT ASSEMBLY	
CHECKED: <b>T. Yin</b>	DATE: <b>09/15/06</b>	<b>PART NO.:</b> PM3XXX	REVISION: A
		<b>CAGE CODE :</b> 32559	<b>SHEET #</b> 5 OF 5
<small>CAD GENERATED DOCUMENT. DO NOT MEASURE DRAWING.</small>			