

Part Number: ACDA03-41SRWA-F01

Super Bright Red

Features

- 0.3 inch digit height.
- Low current operation.
- Excellent character appearance.
- Mechanically rugged.
- Package :300pcs / reel.
- Gray face, white segment.
- Moisture sensitivity level : level 2a.
- RoHS compliant.

Description

The Super Bright Red source color devices are made with Gallium Aluminum Arsenide Red Light Emitting Diode.

Package Dimensions & Internal Circuit Diagram

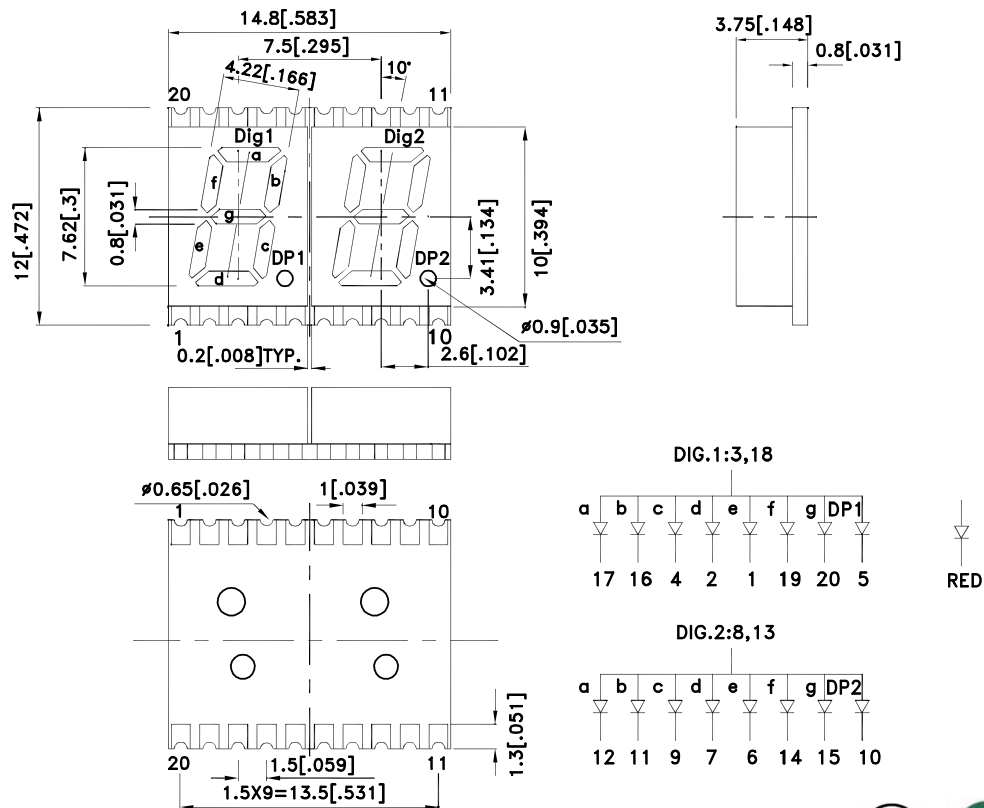

Notes:

1. All dimensions are in millimeters (inches), Tolerance is $\pm 0.25(0.01)$ unless otherwise noted.
2. The specifications, characteristics and technical data described in the datasheet are subject to change without prior notice.
3. The gap between the reflector and PCB shall not exceed 0.25mm.



Selection Guide

| Part No. | Dice | Lens Type | Iv (ucd) [1] @ 10mA | | Description |
|-------------------|---------------------------|----------------|------------------------|------|---------------------------------|
| | | | Min. | Typ. | |
| ACDA03-41SRWA-F01 | Super Bright Red (GaAlAs) | White Diffused | 5600 | 9800 | Common Anode, Rt. Hand Decimal. |

Note:

1. Luminous intensity/ luminous Flux: +/-15%.

Electrical / Optical Characteristics at TA=25°C

| Symbol | Parameter | Device | Typ. | Max. | Units | Test Conditions |
|-----------------------|--------------------------|------------------|------|------|-------|---------------------------|
| λ_{peak} | Peak Wavelength | Super Bright Red | 660 | | nm | I _F =20mA |
| λ_D [1] | Dominant Wavelength | Super Bright Red | 640 | | nm | I _F =20mA |
| $\Delta\lambda_{1/2}$ | Spectral Line Half-width | Super Bright Red | 20 | | nm | I _F =20mA |
| C | Capacitance | Super Bright Red | 45 | | pF | V _F =0V;f=1MHz |
| V _F [2] | Forward Voltage | Super Bright Red | 1.85 | 2.5 | V | I _F =20mA |
| I _R | Reverse Current | Super Bright Red | | 10 | uA | V _R =5V |

Notes:

1. Wavelength: +/-1nm.

2. Forward Voltage: +/-0.1V.

Absolute Maximum Ratings at TA=25°C

| Parameter | Super Bright Red | Units |
|---------------------------------|------------------|-------|
| Power dissipation | 75 | mW |
| DC Forward Current | 30 | mA |
| Peak Forward Current [1] | 155 | mA |
| Reverse Voltage | 5 | V |
| Operating / Storage Temperature | -40°C To +85°C | |

Note:

1. 1/10 Duty Cycle, 0.1ms Pulse Width.

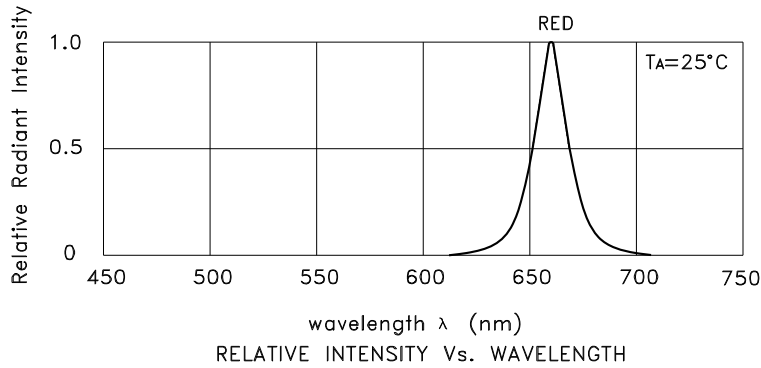

Super Bright Red ACDA03-41SRWA-F01

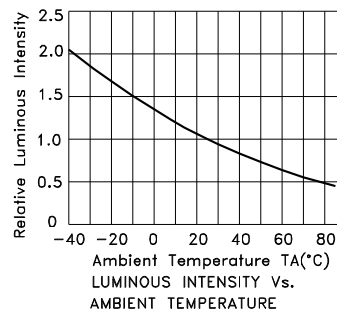
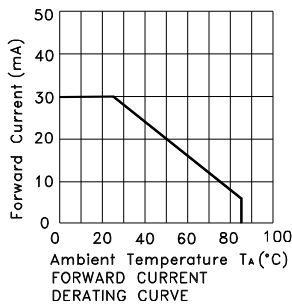
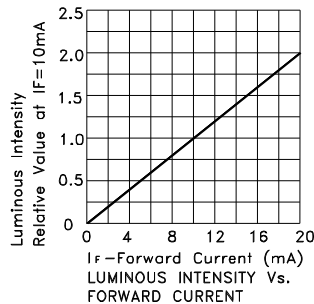
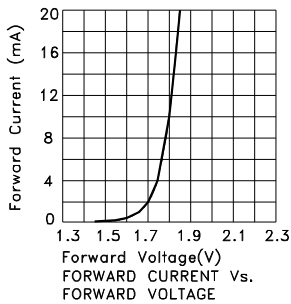

CIRCUIT DESIGN NOTES

1. Protective current-limiting resistors may be necessary to operate the Displays.
2. LEDs mounted in parallel should each be placed in series with its own current-limiting resistor.

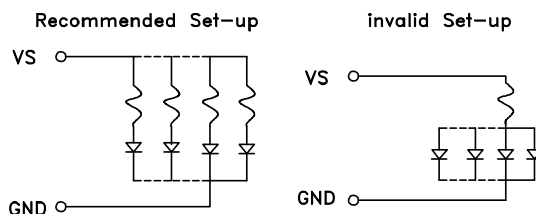

PACKING & LABEL SPECIFICATIONS

ACDA03-41SRWA-F01

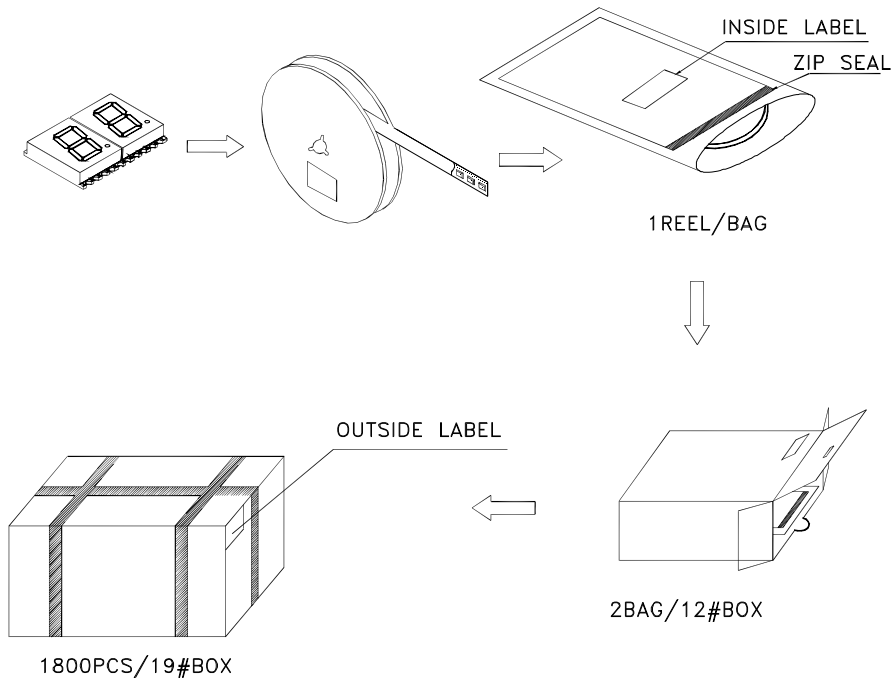

Inside Label On Tape

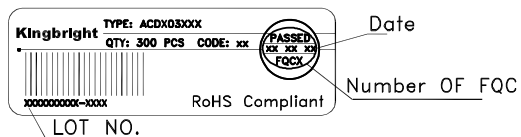

Outside Label On Bag

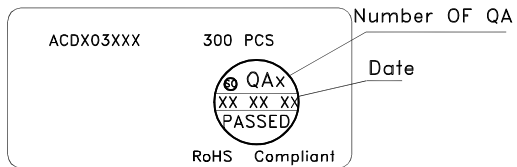

Outside Label On 19#Box

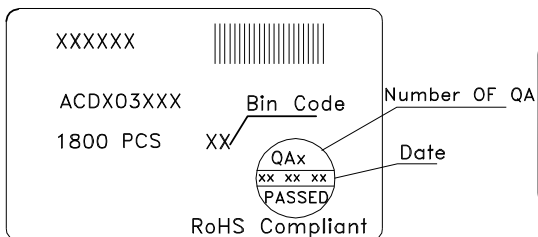

Outside Label On 12#Box

