

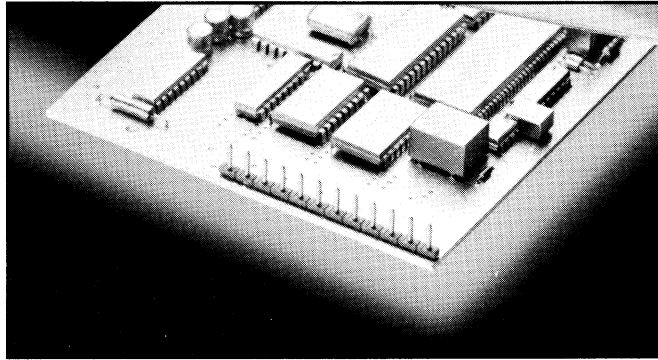



EDSTL 130



2-24 poles, Spacing 5.0 mm
insert required no. of poles **
How to order see page 6

Ratings:

	 UL1059	 CSA 22.2 No. 158	 DIN VDE 0627
Rated Voltage	250 VB	150 VB	250 V
Rated Current	10 A	10 A	10 A (T60)
Test Voltage			2.21 kV

Dimensions

Spacing	5.0 mm
PCB Hole Diameter	1.5 mm

Materials

Insulating Material	PA
Flammability Class	UL94 V-0
Temperature Range	-30°C/+105°C
Contact Pin	CuZn
Color	Black

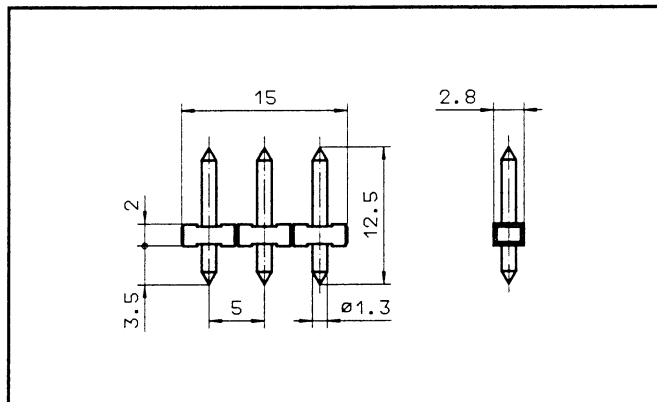

EDSTL

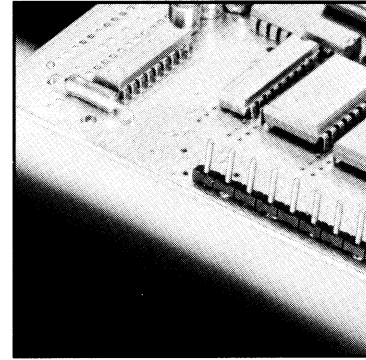

Ratings:

	 UL1059
Rated Voltage	250 VB
Rated Current	10 A
Test Voltage	

Dimensions

Spacing	5.0 mm
PCB Hole Diameter	1.5 mm

Materials

Insulating Material	PA
Flammability Class	UL94 V-0
Temperature Range	-30°C/+105°C
Contact Pin	CuZn
Color	Black

