

REV	DATE	BY	CHK	APPV
C3	11MAR2011	AK	HMR	

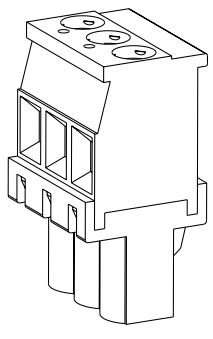

- ⚠ MATERIALS AND FINISH
HOUSING: PA 6-6, UL 94-V0, COLOR GREEN.
CLAMP: BRASS, NICKEL PLATED.
DOUBLE SIDE CONTACT SPRING: PHOSPHOR BRONZE, TIN PLATED.
CLAMPING SCREW: W3, BRASS, NICKEL PLATED.
- 2 WIRE SIZE RANGE:
12 - 30 AWG
- ⚠ NOT CUMULATIVE TOLERANCE.
- ⚠ PRELIMINARY
- ⚠ SPECIAL MARKING TO BE PERMANENT BLACK LETTERING

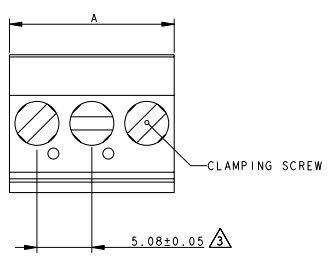
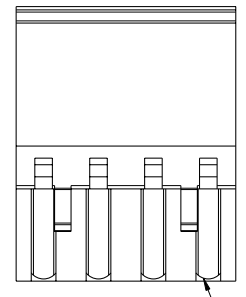
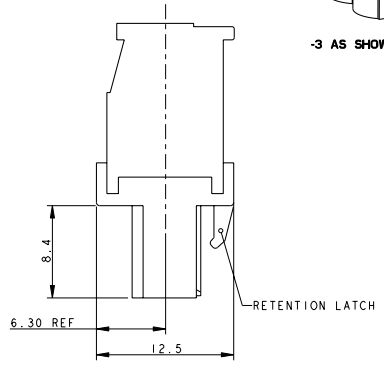
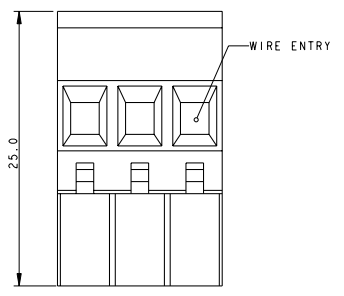

NO	DATE	REV	DESCRIPTION
20.32	4	2-284041-7	
20.32	4	2-284041-6	
127.00	25	2-284041-5	
121.92	24	2-284041-4	
116.84	23	2-284041-3	
111.76	22	2-284041-2	
106.68	21	2-284041-1	
101.60	20	2-284041-0	
96.52	19	1-284041-9	
91.44	18	1-284041-8	
86.36	17	1-284041-7	
81.28	16	1-284041-6	
76.20	15	1-284041-5	
71.12	14	1-284041-4	
66.04	13	1-284041-3	
60.96	12	1-284041-2	
55.88	11	1-284041-1	
50.80	10	1-284041-0	
45.72	9	284041-9	
40.64	8	284041-8	
35.56	7	284041-7	
30.48	6	284041-6	
25.40	5	284041-5	
20.32	4	284041-4	
15.24	3	284041-3	
10.16	2	284041-2	

DIM. A NO OF POS. PART NUMBER

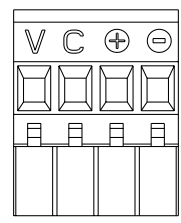
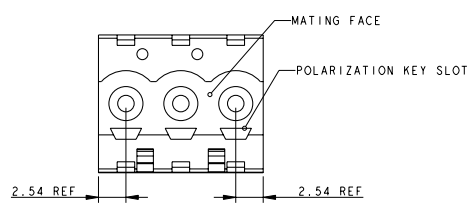

THIS DRAWING IS A CONTROLLED DOCUMENT. DWG NO: 27MAR2001

DESIGNED BY: F. ZANOLINI

CHECKED BY: D. BIEVENOUR

APPROVED BY: D. BIEVENOUR

DATE: 27MAR2001

NAME: D. BIEVENOUR

PRODUCT SPEC: -

APPLICATION SPEC: -

WEIGHT: -

MATERIAL: -

FINISH: -

CUSTOMER DRAWING

SCALE: 4:1

SHEET 1 OF 1

REV C3

RESTRICTED TO: -

TE Connectivity

TERMINAL BLOCK, VERTICAL PLUG STACKING, LEFT HAND 5.08mm PITCH

SHEET CASE CODE DRAWING NO: A200779 ©=284041