

THIS DRAWING IS UNPUBLISHED. RELEASED FOR PUBLICATION. ALL RIGHTS RESERVED.

REV	DATE	BY	CHK	APPROV
1	11MAR2011	BR	HMR	

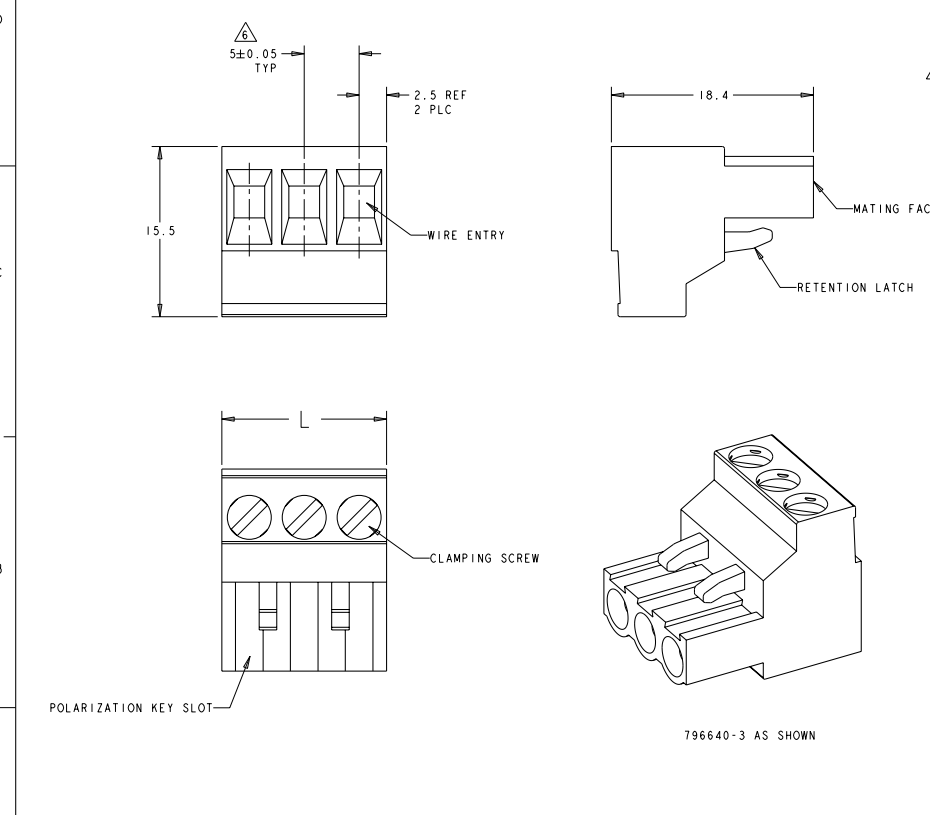

MARK	DESCRIPTION	QTY	UNIT	PRICE	NO OF POSN	PART NUMBER
MARK 4 TO 1		20.00		4		5-796640-4
MARK 3 TO 1		15.00		3		5-796640-3
MARK 1 TO 3		15.00		3		5-796640-2
MARK 1 TO 3		15.00		3		5-796640-1
MARK 1 TO 4		20.00		4		5-796640-0
MARK 15 TO 28		70.00		14		4-796640-9
MARK 13 TO 24		60.00		12		4-796640-8
MARK 1 TO 14		70.00		14		4-796640-7
MARK 1 TO 12		60.00		12		4-796640-6
MARK 1 TO 7		35.00		7		4-796640-5
MARK 1 TO 5		25.00		5		4-796640-4
MARK 11 TO 15		25.00		5		4-796640-3
DETAIL S		35.00		7		4-796640-2
MARK 1 TO 3		15.00		3		4-796640-1
		20.00		4		4-796640-0
DETAIL P		20.00		4		3-796640-9
MARK 1 TO 8		40.00		8		3-796640-8
MARK 37 TO 54		90.00		18		3-796640-7
MARK 19 TO 36		90.00		18		3-796640-6
MARK 1 TO 18		90.00		18		3-796640-5
MARK 1 TO 10		50.00		10		3-796640-4
MARK 1 TO 8		40.00		8		3-796640-3
DETAIL N		30.00		6		3-796640-0
MARK 1 TO 6		30.00		6		2-796640-9
		125.00		25		2-796640-5
		120.00		24		2-796640-4
		115.00		23		2-796640-3
		110.00		22		2-796640-2
		105.00		21		2-796640-1
		100.00		20		2-796640-0
		95.00		19		1-796640-9
		90.00		18		1-796640-8
		85.00		17		1-796640-7
		80.00		16		1-796640-6
		75.00		15		1-796640-5
		70.00		14		1-796640-4
		65.00		13		1-796640-3
		60.00		12		1-796640-2
		55.00		11		1-796640-1
		50.00		10		1-796640-0
		45.00		9		796640-9
		40.00		8		796640-8
		35.00		7		796640-7
		30.00		6		796640-6
		25.00		5		796640-5
		20.00		4		796640-4
		15.00		3		796640-3
		10.00		2		796640-2

796640-3 AS SHOWN

THIS DRAWING IS A CONTROLLED DOCUMENT. DATE: 18OCT2000. BY: S. WELDON. CHECKED BY: D. BIEVENOUR. APPROVED BY: D. BIEVENOUR. PRODUCT SPEC: APPLICATION SPEC. WEIGHT: CUSTOMER DRAWING. SHEET: A200779. SCALE: 4:1. SHEET 1 OF 2. REV F8.

**TE Connectivity**  
**TE**  
 TERMINAL BLOCK, PLUG, STACKING  
 5.00mm PITCH

4

3

2

1

THIS DRAWING IS UNPUBLISHED. RELEASED FOR PUBLICATION. ALL RIGHTS RESERVED.

LOC	DISP	REV	DATE	BY	APPR
-	-	1	-	-	-
DESCRIPTION					
SEE SHEET 1					

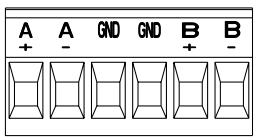

DETAIL N

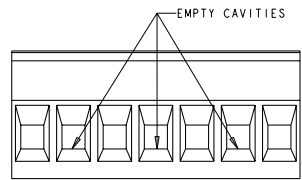

DETAIL S

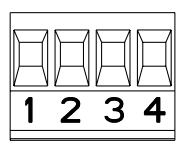

DETAIL P

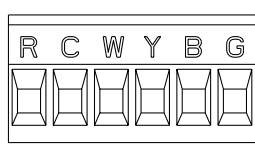

DETAIL T

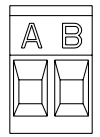

DETAIL U

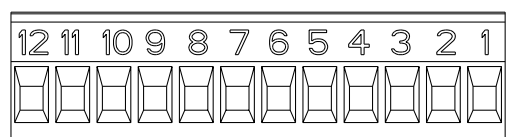

DETAIL V

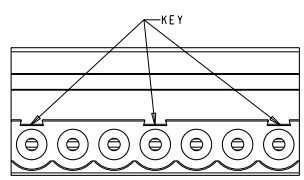

DETAIL W

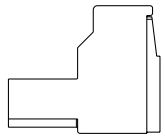

- △ MATERIALS AND FINISH:  
HOUSING: PA 6-6, UL 94-V0, COLOR: GREEN.  
CLAMP: BRASS, NICKEL PLATED.  
DOUBLE SIDE CONTACT SPRING: PHOSPHOR BRONZE, PLATING: SEE TABLE.  
CLAMPING SCREW: M3, BRASS, NICKEL PLATED.
- 2. END-TO-END STACKABLE WITHOUT LOSS OF CENTERLINE SPACING.
- 3. WIRE SIZE RANGE: 12-30 AWG.
- 4. RECOGNIZED UNDER THE COMPONENT PROGRAM OF UNDERWRITERS LABORATORIES INC. FILE N° E60677.
- 5. IMO CERTIFICATE WITH SURVEILLANCE IN CONFORMITY WITH IEC 998-1/998-2-1.
- △ NOT CUMULATIVE TOLERANCE
- △ INK MARKING: BLACK COLOR.
- △ INK MARKING: WHITE COLOR.
- △ NUMERICAL SEQUENCE: FROM LEFT TO RIGHT, WIRE ENTRY SIDE.
- △ RETENTION LATCHES REMOVED
- 11. BUCHANAN LOGO TO APPEAR ON HOUSING, LOCATION OPTIONAL WHERE SPACE PERMITS.
- △ WIRE ENTRY CLOSED.
- △ PRELIMINARY - NOT FOR PRODUCTION.
- △ NUMERICAL SEQUENCE: FROM RIGHT TO LEFT, WIRE ENTRY SIDE.

MARKING	DESCRIPTION	QTY	UNIT	REF	PART NUMBER	
△	TIN	-	DETAIL W, NO LATCH	35.00	7	6-796640-1
△	TIN	△	KEY POSN 1, 4, 7	60.00	12	6-796640-0
△	GOLD FLASH	△	DETAIL V	35.00	7	5-796640-9
△	TIN	△	DETAIL U	10.00	2	5-796640-8
△	TIN	△	DETAIL T	30.00	6	5-796640-7
△	TIN	△	MARK 13 TO 24	60.00	12	5-796640-6
△	TIN	△	MARK 25 TO 38	70.00	14	5-796640-5
△	TERMINAL PLATING	△	MARKING	SPECIAL	L	NO OF POSN

THIS DRAWING IS A CONTROLLED DOCUMENT. DWG. S. WELDON 180CT2000  
 CH. D. BIEVENOUR 180CT2000  
 APPR. D. BIEVENOUR 180CT2000

**TE** TE Connectivity

TERMINAL BLOCK, PLUG, STACKING  
 5.00mm PITCH

DIMENSIONS: mm

MATERIAL: -

WEIGHT: -

CUSTOMER DRAWING

SHEET CASE CODE DRAWING NO. RESTRICTED TO  
 A200779 C-796640 -

SCALE 4:1 SHEET 2 OF 2 REV E 8