

THIS DRAWING IS UNPUBLISHED. RELEASED FOR PUBLICATION AUG. 2006.  
 © COPYRIGHT 2009 BY TYCO ELECTRONICS CORPORATION. ALL RIGHTS RESERVED.

LOC	DIST	REVISIONS			
P	LTR	DESCRIPTION	DATE	DWN	APVD
A1		REVISED (ECR-09-018582)	19AUG09	JL	WK

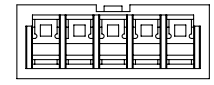

23.60	23.20	21.00	15	1-1775441-5
22.10	21.70	19.50	14	1-1775441-4
20.60	20.20	18.00	13	1-1775441-3
19.10	18.70	16.50	12	1-1775441-2
17.60	17.20	15.00	11	1-1775441-1
16.10	15.70	13.50	10	1-1775441-0
14.60	14.20	12.00	9	1775441-9
13.10	12.70	10.50	8	1775441-8
11.60	11.20	9.00	7	1775441-7
10.10	9.70	7.50	6	1775441-6
8.60	8.20	6.00	5	1775441-5
7.10	6.70	4.50	4	1775441-4
5.60	5.20	3.00	3	1775441-3
4.10	3.70	1.50	2	1775441-2
C	B	A	POS.	PART NUMBER

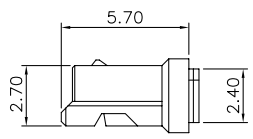
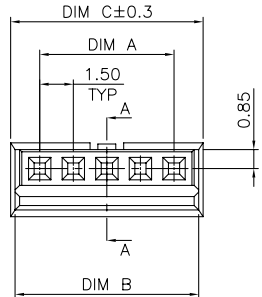
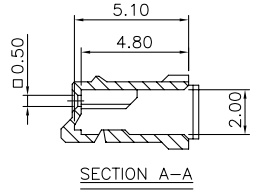
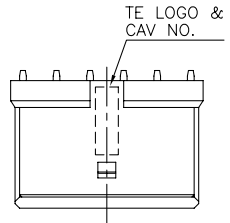
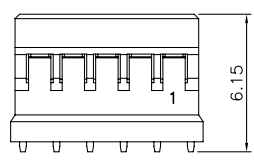

THIS DRAWING IS A CONTROLLED DOCUMENT.

DWN J. LAI 19AUG2009	Tyco Electronics Corporation Taipei, Taiwan
CHK S. CHIEN 19AUG2009	
APVD W. KODAMA 19AUG2009	NAME EMIX CONN., 1.5mm PITCH RCPT, HOUSING
PRODUCT SPEC 108-57631	SIZE A3
QUALIFICATION TEST REPORT 501-57736	CAGE CODE 00779
MATERIAL SEE NOTE	DRAWING NO. C=1775441
FINISH SEE NOTE	RESTRICTED TO -
WEIGHT - GRAMS	SCALE -
CUSTOMER DRAWING	SHEET 1 of 2
	REV A1

- NOTES:
- MATERIALS:  
HOUSING: THERMOPLASTIC, UL 94-V0, COLOR: NATURAL.
  - APPLY TERMINAL PART NO: 1775442-1.

THIS DRAWING IS UNPUBLISHED. RELEASED FOR PUBLICATION AUG. 2006.  
 © COPYRIGHT 2009 BY TYCO ELECTRONICS CORPORATION. ALL RIGHTS RESERVED.

LOC	DIST	REVISIONS			
P	LTR	DESCRIPTION	DATE	DWN	APVD
		SEE SHEET 1.			

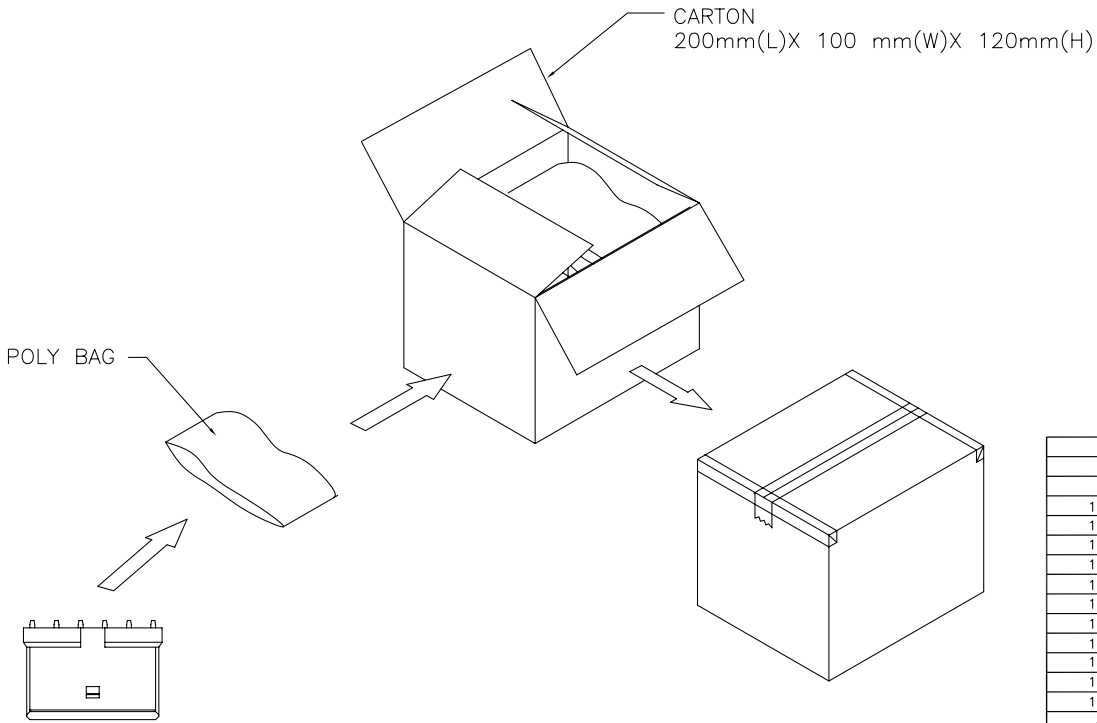

8,000	1,000	15	1-1775441-5
8,000	1,000	14	1-1775441-4
8,000	1,000	13	1-1775441-3
10,000	1,000	12	1-1775441-2
10,000	1,000	11	1-1775441-1
10,000	1,000	10	1-1775441-0
12,000	1,000	9	1775441-9
12,000	1,000	8	1775441-8
12,000	1,000	7	1775441-7
12,000	1,000	6	1775441-6
12,000	1,000	5	1775441-5
12,000	1,000	4	1775441-4
12,000	1,000	3	1775441-3
12,000	1,000	2	1775441-2
APQ (PCS/CARTON)	PPQ (PCS/BAG)	POS.	PART NUMBER

THIS DRAWING IS A CONTROLLED DOCUMENT.		DWN	Tyco Electronics Corporation Taipei, Taiwan	
DIMENSIONS: MM		CHK	NAME	
TOLERANCES UNLESS OTHERWISE SPECIFIED:		APVD	EMIX CONN., 1.5mm PITCH RCPT, HOUSING	
0 PLC ± -		PRODUCT SPEC	SIZE	
1 PLC ± -		APPLICATION SPEC	CAGE CODE	
2 PLC ± -		WEIGHT	DRAWING NO	
3 PLC ± -			A3 00779 C=1775441	
4 PLC ± -			RESTRICTED TO	
ANGLES ± -			-	
MATERIAL	FINISH	CUSTOMER DRAWING		SCALE
				SHEET
				2 of 2
				REV A1