

9422876

('ON (DRAWING NO.)

版数 REV.	年月日 DATE	DCN NO.	変更内容 DESCRIPTION	製図 DR.	担当 CHK.	査閲 APPD.	承認 APPD.
6	8.Sep.2003	053208	CHANGED TO BILINGUAL REDRAWN etc.		S.HARA	T. Nakano	Hogari

REFERENCE
(参考)

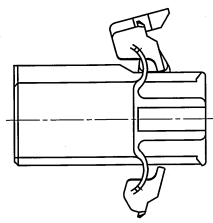

SECT. A-A
(SCALE 5:1)

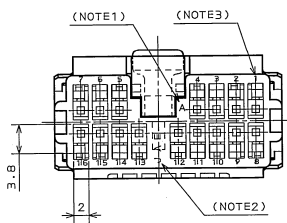
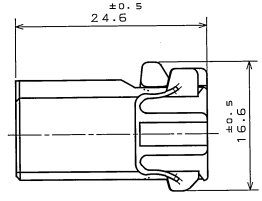
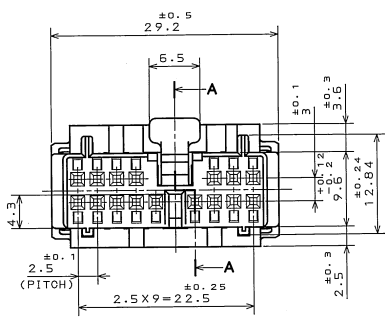
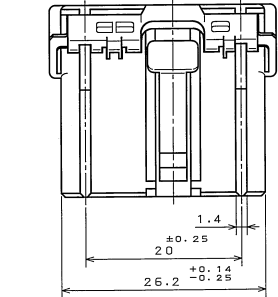
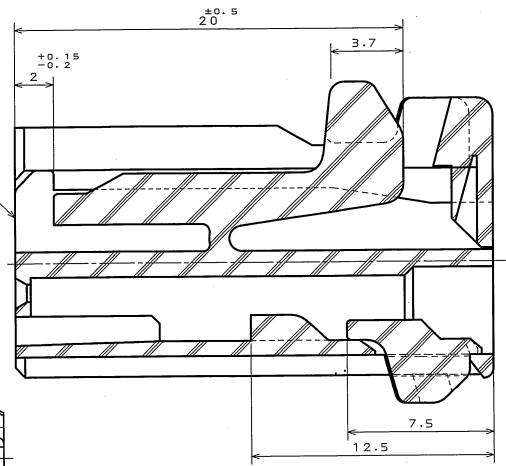

NOTE1. MOLD CAVITY DESIGNATOR APPEARS IN RAISED LETTERS.
NOTE2.
NOTE3.

注1. 金型マークを浮き出す。
注2. 社標を浮き出す。
注3. 端子No. を浮き出す。

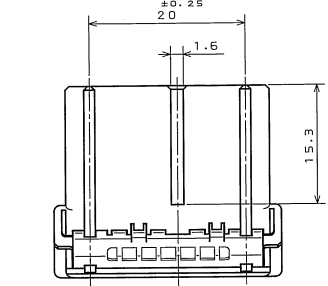

1	SOCKET HOUSING	1	PBT	COLOR: GREEN
符号 NO.	名称 DESCRIPTION	個数 QTY.	材料 MATERIAL	備考 REMARKS
仕様書(SPECIFICATION)	JACS-1309	第1版(ORIGINAL DATE)	10.Feb.1988	
製図 DR.	H.TSUCHIYA	名称(TITLE)	IL-A05-16S	
指導 CHK.	Y.ICHIIYAMA	仕上 FINISH	-D3C1-A	
APPD.	I.IIMORI	社標		
承認 APPD.	K.TAKEDA	重量(WEIGHT)		

JAE CONNECTOR DIV. PROPRIETARY.
COPYRIGHT (C) 1988, JAPAN AVIATION ELECTRONICS INDUSTRY, LTD.

DOF-0-212E(03.08)

