

13 12 11 10 9 8 7 6 5 4 3 2 1

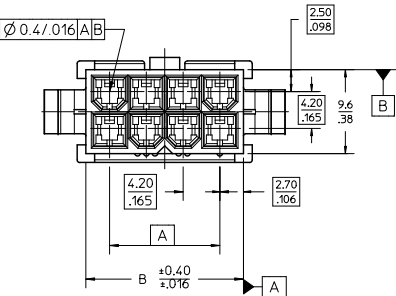

- NOTES:
- 1) MATERIAL:
 "BLANK" = NYLON 6/6, 94V-2, COLOR: NATURAL.
 "BL" = NYLON 6/6, 94V-2, COLOR: BLACK.
 "BU" = NYLON 6/6, 94V-2, COLOR: BLUE.
 "RE" = NYLON 6/6, 94V-2, COLOR: RED.
 "210" = NYLON 6/6, 94V-0, COLOR: NATURAL.
 - 2) FINISH: NOT APPLICABLE
 - 3) PRODUCT SPECIFICATION: PS-5556-001
 - 4) PACKAGING: BULK
 - 5) PART MATES WITH MOLEX RECEPTACLE #5557.
 - 6) PART TO BE USED WITH MOLEX MALE TERMINAL #5558.
 - 7) PART IS NOT DESIGNED FOR CURRENT SHARING.
 - 8) CONNECTORS ARE NOT TO BE MATED OR UNMATED WHILE CIRCUITS ARE LIVE.
 - 9) WIRES ARE TO BE DRESSED IN SUCH A MANNER TO ALLOW THE TERMINALS TO FLOAT FREELY IN THE POCKET.
 - 10) PART CONFORMS TO CLASS 'B' REQUIREMENTS OF COSMETIC SPECIFICATION PS-45499-002 WITH THE EXCEPTION OF DISCOLORATION, FLASH AND SINK MEET CLASS 'C' REQUIREMENTS.
- RECOMMENDED PANEL HOLE DIMENSIONS**
 (THICKNESS : 0.8-2.0(.032-.079))

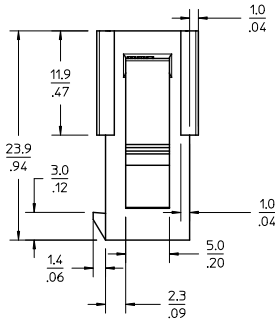
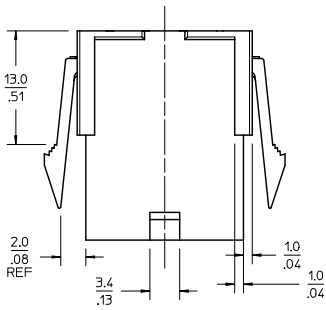
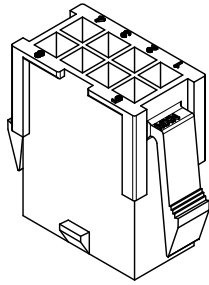
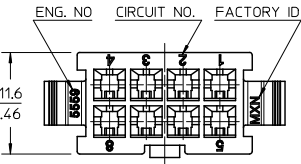
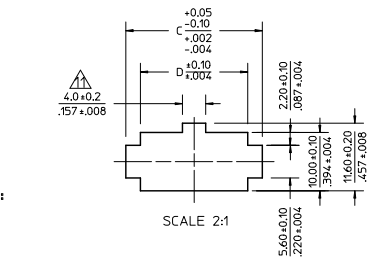
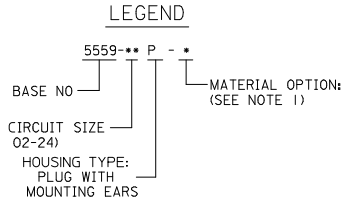

RECOMMENDED PANEL HOLE DIMENSIONS
 (THICKNESS : 0.8-2.0(.032-.079))

52.1/2.051	51.0/2.244	51.6/2.031	46.2/1.819	24
47.9/1.886	52.8/2.079	47.4/1.866	42.0/1.654	22
43.7/1.720	48.6/1.915	43.2/1.701	37.8/1.488	20
39.5/1.555	44.4/1.748	39.0/1.535	33.6/1.323	18
35.3/1.390	40.2/1.583	34.8/1.370	29.4/1.158	16
31.1/1.224	36.0/1.417	30.6/1.205	25.2/992	14
26.8/1.055	31.8/1.252	26.4/1.039	21.0/827	12
22.6/890	27.6/1.087	22.2/874	16.8/661	10
18.4/724	23.4/921	18.0/709	12.6/496	8
14.2/559	19.2/756	13.8/543	8.4/331	6
10.0/394	15.0/591	9.6/378	4.2/165	4
5.8/228	10.8/425	5.4/213	—	2
				A
				CIRCUIT

REMOVED -04P-RE EC NO: UCP200-2477 DRWN: JAGUILAR 2010/04/09 CHKD: BELL 2010/08/26 APPR: SMITH 2010/08/27	QUALITY SYMBOLS □=0 ▽=0 ▽=0	GENERAL TOLERANCES (UNLESS SPECIFIED):	DIMENSION STYLE	SCALE	DESIGN UNITS	THIRD ANGLE PROJECTION	
		mm	MM/IN	3:1	METRIC	□	
		4 PLACES ±.005 ±.012	DRAWN BY H. HIRAMOTO 1988/10/14	DATE	TITLE	NEW MINI FIT CONNECTOR CRIMP PIN HOUSING	
		3 PLACES ±.012 ±.016	CHECKED BY Y. YAMADA 1988/10/21	DATE			
2 PLACES ±.016 ±.020	APPROVED BY M. ENOMOTO 1988/10/24	DATE					
1 PLACE ±.020 ±.025							
ANGULAR ± 3°							
DRAFT WHERE APPLICABLE MUST REMAIN WITHIN DIMENSIONS	SEE CHART			SD-5559-NP			
				MATERIAL NO. DOCUMENT NO. SHEET NO. 1 OF 2			

12 11 10 9 8 7 6 5 4 3 2 1

13 12 11 10 9 8 7 6 5 4 3 2 1

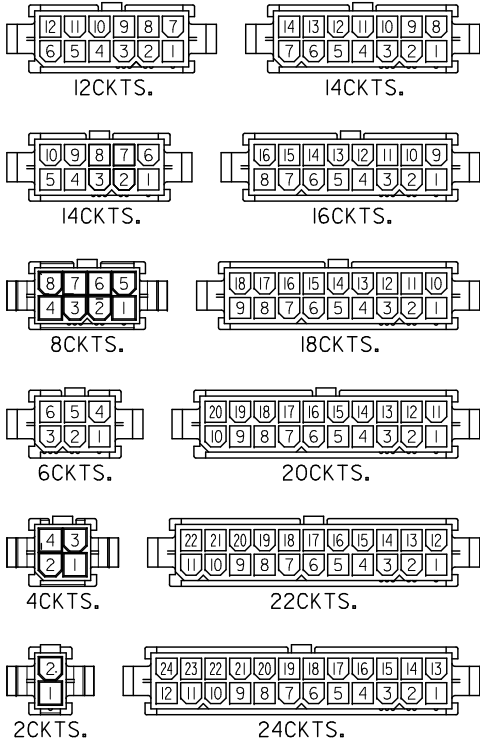

CIRCUIT SIZE LAYOUT (SCALE : 2-1)

V-2 BLACK		V-2 BLUE		V-2 RED		V-0 NATURAL		V-2 NATURAL			
EDP NO.	ENG. NO.	CIRCUIT	EDP NO.	ENG. NO.	CIRCUIT	EDP NO.	ENG. NO.	CIRCUIT	EDP NO.	ENG. NO.	CIRCUIT
		24			24	39-01-2246	5559-24P-210	24	39-01-2241	5559-24P	24
		22			22	-2226	-22P-210	22	-2221	-22P	22
		20			20	-2206	-20P-210	20	-2201	-20P	20
		18			18	-2186	-18P-210	18	-2181	-18P	18
		16			16	-2166	-16P-210	16	-2161	-16P	16
		14			14	-2146	-14P-210	14	-2141	-14P	14
		12			12	-2126	-12P-210	12	-2121	-12P	12
		10			10	-2106	-10P-210	10	-2101	-10P	10
		8			8	-2086	-08P-210	8	-2081	-08P	8
		6			6	-2066	-06P-210	6	-2061	-06P	6
		4			4	-2046	-04P-210	4	-2041	-04P	4
		2			2	39-01-2026	5559-02P-210	2	39-01-2021	5559-02P	2
39-02-80655569-06P-BL		6			6	39-02-80675559-06P-RE					
39-02-80455569-04P-BL		4			4						
		2			2						
		CIRCUIT			CIRCUIT				CIRCUIT		CIRCUIT

QUALITY SYMBOLS	GENERAL TOLERANCES (UNLESS SPECIFIED)		DIMENSION STYLE		SCALE		DESIGN UNITS		THIRD ANGLE PROJECTION	
	mm	INCH	MM/IN	DATE	2:1	METRIC	⊙	THIRD ANGLE	PROJECTION	
▽=0	4 PLACES ±.005	±.0005	H. HIRAMOTO	1988/10/14	TITLE		NEW MINI. FIT CONNECTOR CRIMP PIN HOUSING			
▽=0	3 PLACES ±.012	±.005	CHECKED BY	DATE	MATERIAL NO.		SD-5559-NP			
▽=0	2 PLACES ±.030	±.016	Y. YAMADA	1988/10/21	DOCUMENT NO.		SD-5559-NP			
▽=0	1 PLACE ±.40	±.016	M. ENOMOTO	1988/10/24	SHEET NO.		2 OF 2			
ANGULAR ± 3°			SIZE		THIS DRAWING CONTAINS INFORMATION THAT IS PROPRIETARY TO MOLEX INCORPORATED AND SHOULD NOT BE USED WITHOUT WRITTEN PERMISSION					