

13 12 11 10 9 8 7 6 5 4 3 2 1

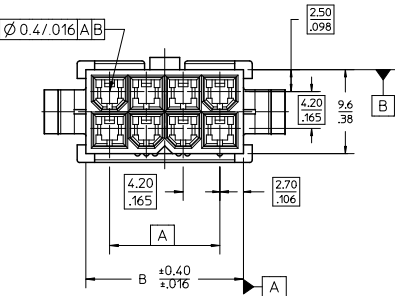

NOTES:
 1) MATERIAL:
 BLANK = NYLON 6/6, 94V-2, COLOR: NATURAL.
 BL = NYLON 6/6, 94V-2, COLOR: BLACK.
 BU = NYLON 6/6, 94V-2, COLOR: BLUE.
 RE = NYLON 6/6, 94V-2, COLOR: RED.
 210 = NYLON 6/6, 94V-0, COLOR: NATURAL.
 2) FINISH: NOT APPLICABLE
 3) PRODUCT SPECIFICATION: PS-5556-001
 4) PACKAGING: BULK
 5) PART MATES WITH MOLEX RECEPTACLE #5557.
 6) PART TO BE USED WITH MOLEX MALE TERMINAL #5558.
 7) PART IS NOT DESIGNED FOR CURRENT SHARING.
 8) CONNECTORS ARE NOT TO BE MATED OR UNMATED WHILE CIRCUITS ARE LIVE.
 9) WIRES ARE TO BE DRESSED IN SUCH A MANNER TO ALLOW THE TERMINALS TO FLOAT FREELY IN THE POCKET.
 10) PART CONFORMS TO CLASS 'B' REQUIREMENTS OF COSMETIC SPECIFICATION PS-45499-002 WITH THE EXCEPTION OF DISCOLORATION, FLASH AND SINK MEET CLASS 'C' REQUIREMENTS.
 ⚠️ ON 2 CIRCUITS PARTS THIS DIMENSION IS ALLOWABLE UP TO 'D' DIMENSION.
 ⚠️ PANEL HOLE TO BE PUNCHED OUT IN THE SAME DIRECTION AS INSERTION INTO THE PANEL.

LEGEND
 5559-**-P-**-
 BASE NO. MATERIAL OPTION: (SEE NOTE 1)
 CIRCUIT SIZE 02-24
 HOUSING TYPE: PLUG WITH MOUNTING EARS

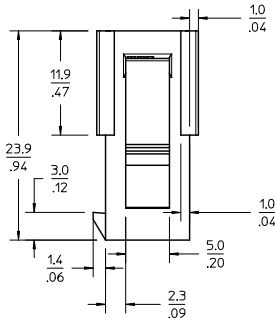
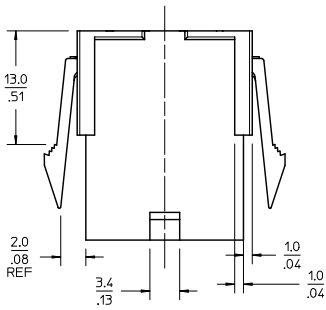
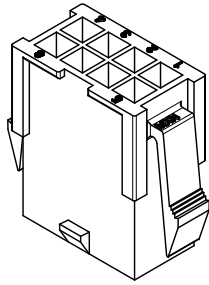
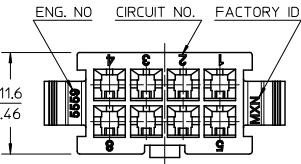
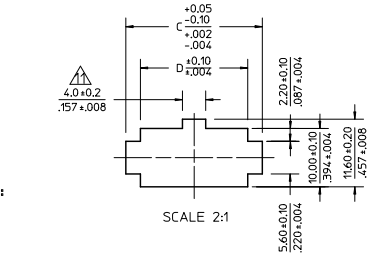

RECOMMENDED PANEL HOLE DIMENSIONS
 (THICKNESS : 0.8-2.0/0.32-.079)

52.1/2.051	51.0/2.244	51.6/2.031	46.2/1.819	24
47.9/1.886	52.8/2.079	47.4/1.866	42.0/1.654	22
43.7/1.720	48.6/1.915	43.2/1.701	37.8/1.488	20
39.5/1.555	44.4/1.748	39.0/1.535	33.6/1.323	18
35.3/1.390	40.2/1.583	34.8/1.370	29.4/1.158	16
31.1/1.224	36.0/1.417	30.6/1.205	25.2/0.992	14
26.8/1.055	31.8/1.252	26.4/1.039	21.0/0.827	12
22.6/0.890	27.6/1.087	22.2/0.874	16.8/0.661	10
18.4/0.724	23.4/0.921	18.0/0.709	12.6/0.496	8
14.2/0.559	19.2/0.756	13.8/0.543	8.4/0.331	6
10.0/0.394	15.0/0.591	9.6/0.378	4.2/0.165	4
5.8/0.228	10.8/0.425	5.4/0.213	—	2
				A
				CIRCUIT

REMOVED -04P-RE EC NO: UCP200-2477 DRAWN: JAGUILAR 2010/04/09 CHKD: BELL 2010/08/26 APPR: SMITH 2010/08/27	QUALITY SYMBOLS □=0 ▽=0 ▽=0	GENERAL TOLERANCES (UNLESS SPECIFIED):	DIMENSION STYLE MM/IN	SCALE 3:1	DESIGN UNITS METRIC	THIRD ANGLE PROJECTION
		4 PLACES ±.005 ±.005	DRAWN BY H. HIRAMOTO DATE 1988/10/14	TITLE NEW MINI FIT CONNECTOR CRIMP PIN HOUSING		
		3 PLACES ±.012 ±.012	CHECKED BY DATE	MOLEX INCORPORATED		
		2 PLACES ±.030 ±.016	APPROVED BY Y. YAMADA DATE 1988/10/21	DOCUMENT NO. SD-5559-NP		
1 PLACE ±.40 ±.005	ANGULAR ± 3°	MATERIAL NO. M.ENOMOTO DATE 1988/10/24	SHEET NO. 1 OF 2			
DRAFT WHERE APPLICABLE MUST REMAIN WITHIN DIMENSIONS		SEE CHART	THIS DRAWING CONTAINS INFORMATION THAT IS PROPRIETARY TO MOLEX INCORPORATED AND SHOULD NOT BE USED WITHOUT WRITTEN PERMISSION			

12 11 10 9 8 7 6 5 4 3 2 1

13 12 11 10 9 8 7 6 5 4 3 2 1

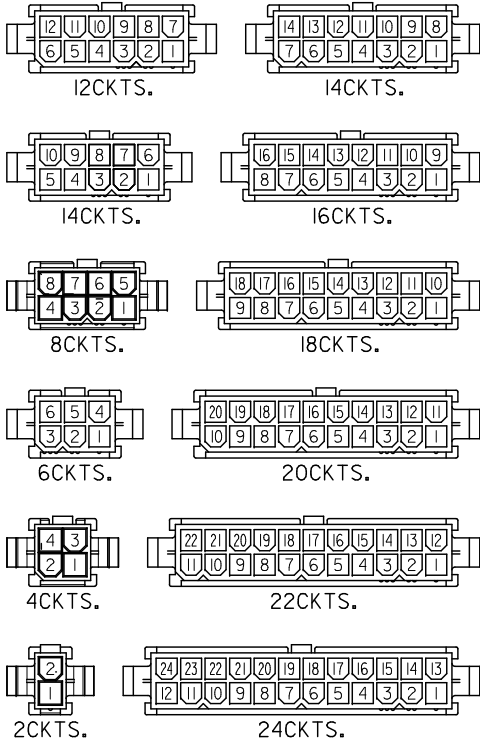

CIRCUIT SIZE LAYOUT (SCALE : 2-1)

V-2 BLACK		V-2 BLUE		V-2 RED		V-0 NATURAL		V-2 NATURAL			
EDP NO.	ENG. NO.	CIRCUIT	EDP NO.	ENG. NO.	CIRCUIT	EDP NO.	ENG. NO.	CIRCUIT	EDP NO.	ENG. NO.	CIRCUIT
		24			24	39-01-2246	5559-24P-210	24	39-01-2241	5559-24P	24
		22			22	-2226	-22P-210	22	-2221	-22P	22
		20			20	-2206	-20P-210	20	-2201	-20P	20
		18			18	-2186	-18P-210	18	-2181	-18P	18
		16			16	-2166	-16P-210	16	-2161	-16P	16
		14			14	-2146	-14P-210	14	-2141	-14P	14
		12			12	-2126	-12P-210	12	-2121	-12P	12
		10			10	-2106	-10P-210	10	-2101	-10P	10
		8			8	-2086	-08P-210	8	-2081	-08P	8
		6			6	-2066	-06P-210	6	-2061	-06P	6
		4			4	-2046	-04P-210	4	-2041	-04P	4
		2			2	39-01-2026	5559-02P-210	2	39-01-2021	5559-02P	2
39-02-80655569-06P-BL		6			6	39-02-80675559-06P-RE					
39-02-80455569-04P-BL		4			4						
		2			2						

EDP NO.	ENG. NO.	DESCRIPTION	QUALITY SYMBOLS	GENERAL TOLERANCES (UNLESS SPECIFIED)	DIMENSION STYLE	SCALE	DESIGN UNITS	THIRD ANGLE PROJECTION
SEE SHEET 1				4 PLACES ±.005 ±.005	MM/IN	2:1	METRIC	THIRD ANGLE PROJECTION
EC NO. UCF2010-2477	2010/04/09			3 PLACES ±.005 ±.012				
DRWN: JAGUILAR	2010/07/26			2 PLACES ±.30 ±.016				
CHKD: BELL	2010/08/27			1 PLACE ±.40 ±.---				
APPR: SMITH				ANGULAR ± 3°				
				DRAFT WHERE APPLICABLE MUST REMAIN WITHIN DIMENSIONS	SEE CHART			
							SD-5559-NP	SHEET NO. 2 OF 2
							THIS DRAWING CONTAINS INFORMATION THAT IS PROPRIETARY TO MOLEX INCORPORATED AND SHOULD NOT BE USED WITHOUT WRITTEN PERMISSION	