

13 12 11 10 9 8 7 6 1625 4 3 2 1

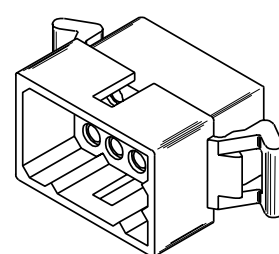
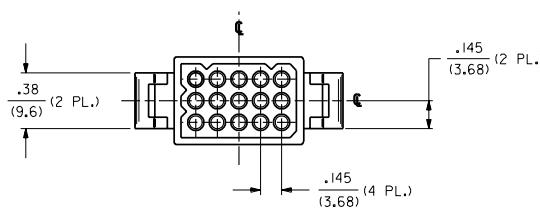
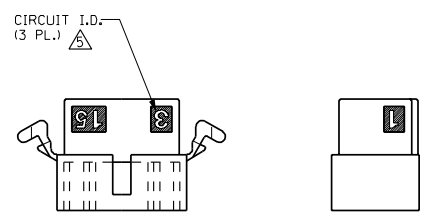
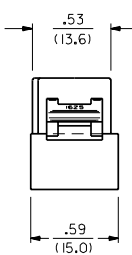
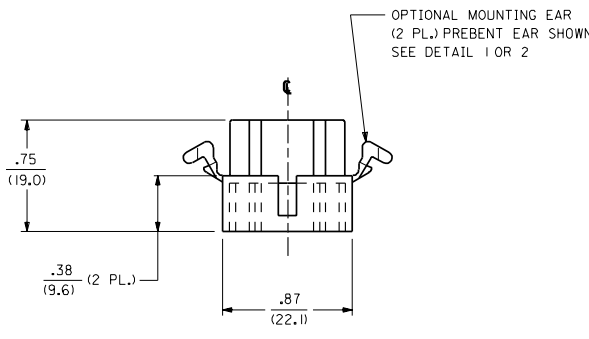
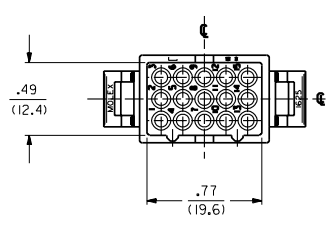

PLUG HOUSING

CHART AND NOTES ON SHEET 3

REV.	DATE	DESCRIPTION
02		REVISION ECN #U70777 97-4-22 JIANG
01		FINAL REL. -15R2 ECN #15 1285 6-22-95 RW
0		REVISE PER ECR U4 0050 C/C 1/12/94 RW
P		REVISE PER ECN #13 0508 4/1/93 RW
0		REVISE PER ECR U2 0850 C/C 8/5/92 RW
N		REVISE PER ECR U1 2251 C/C 11/20/91 RW
M		REVISE PER ECR U1 2108 C/C 10/28/91 RW
L		REMOVE PT. NO. FROM -15R2 ECR U1 1908 C/C 9/20/91 RW
K1		ADDED & FINAL REL PER ERO #28346 GEP 5-4-89 RW
K		ADDED OPTIONS ECR # U82108 KBW 03-22-89 RW
J		ADDED OPTIONS ECR # U82108 KBW 10-10-88 RW
H		REV. & REDRAWN ECR U8 1714 GEP 7-15-88 RW

DIMENSIONS SHOWN: METRIC INCH		REVISION ONLY ON CAD SYSTEM															
UNLESS OTHERWISE SPECIFIED TOLERANCES ANGULAR ± .5°		TITLE															
<table border="1"> <tr> <th>INCH</th> <th>METRIC</th> </tr> <tr> <td>3 PLACE ± .010</td> <td>---</td> </tr> <tr> <td>2 PLACE ± .014</td> <td>+0.25</td> </tr> <tr> <td>1 PLACE ---</td> <td>± 0.35</td> </tr> </table>		INCH	METRIC	3 PLACE ± .010	---	2 PLACE ± .014	+0.25	1 PLACE ---	± 0.35	<table border="1"> <tr> <td>MOLEX INCORPORATED</td> <td>U.S.A.</td> <td>DATE</td> </tr> <tr> <td>1335 E. JOLIET</td> <td>ROSELAND, IL 60532</td> <td>7/15/88</td> </tr> </table>		MOLEX INCORPORATED	U.S.A.	DATE	1335 E. JOLIET	ROSELAND, IL 60532	7/15/88
INCH	METRIC																
3 PLACE ± .010	---																
2 PLACE ± .014	+0.25																
1 PLACE ---	± 0.35																
MOLEX INCORPORATED	U.S.A.	DATE															
1335 E. JOLIET	ROSELAND, IL 60532	7/15/88															
DRAFT WHERE APPLICABLE MUST REMAIN WITHIN DIMENSIONS		PART NO. SD-1625-15															
<table border="1"> <tr> <td>DRG. BY: GEP</td> <td>CHKD. BY: RW</td> <td>FILE NAME: 5162515X1</td> <td>NO DRAWING CONTAINS INFORMATION THAT IS PROPRIETARY TO MOLEX INC. AND SHOULD NOT BE USED WITHOUT WRITTEN PERMISSION.</td> </tr> <tr> <td>APP'D. RAS</td> <td>SCALE: 2:1</td> <td>DRG. NO. SD-1625-15</td> <td>SIZE: CP C</td> </tr> </table>		DRG. BY: GEP	CHKD. BY: RW	FILE NAME: 5162515X1	NO DRAWING CONTAINS INFORMATION THAT IS PROPRIETARY TO MOLEX INC. AND SHOULD NOT BE USED WITHOUT WRITTEN PERMISSION.	APP'D. RAS	SCALE: 2:1	DRG. NO. SD-1625-15	SIZE: CP C	SEE CHART							
DRG. BY: GEP	CHKD. BY: RW	FILE NAME: 5162515X1	NO DRAWING CONTAINS INFORMATION THAT IS PROPRIETARY TO MOLEX INC. AND SHOULD NOT BE USED WITHOUT WRITTEN PERMISSION.														
APP'D. RAS	SCALE: 2:1	DRG. NO. SD-1625-15	SIZE: CP C														

13 12 11 10 9 8 7 6 5 4 3 2 1

13 12 11 10 9 8 7 6 1625 4 3 2 1

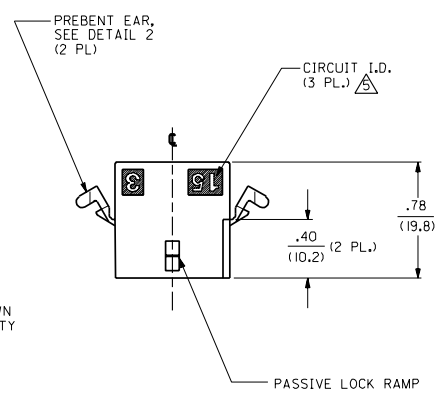
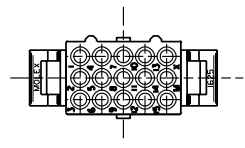

MTG. EAR NOT SHOWN FOR CKT. I.D. CLARITY

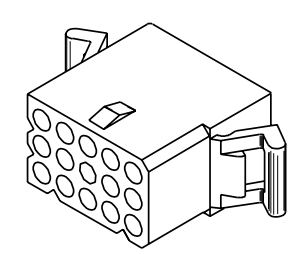
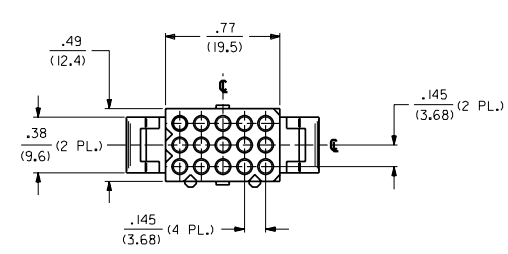

RECEPTACLE HOUSING

CHART AND NOTES ON SHEET 3

		MFG. SH. REV.	
P	SEE SHT. 1	REVISIONS ONLY ON CAD SYSTEM	
Q2	SEE SHT. 1	O	SEE SHT. 1
Q	SEE SHT. 1	H	SEE SHT. 1
LTR.	REVISIONS	LTR.	REVISIONS

DIMENSIONS SHOWN METRIC INCH		TOLERANCES: ANGULAR ± .04°	
UNLESS OTHERWISE SPECIFIED		DRAFT WHERE APPLICABLE MUST REMAIN WITHIN DIMENSIONS	
3 PLACE	± .010	INCH	METRIC
2 PLACE	± .014	± 0.25	
1 PLACE	± .035	± 0.35	
DRAWN BY: CEP		DATE: 7/18/88	
CHKD. BY: RAS		SCALE: 2 : 1	
APP'D. RAS		FILE NAME: S162515X2.DWG	

MOLEX INCORPORATED		SHEET NO. 2	
SEE CHART		DATE: 7/18/88	
PART NO. SD-1625-15•		DRWG. NO.	
TITLE: .062/(1.57) HOUSING; PLUG AND RECEPTACLE; 15 CKT. ±.145/(3.68) CTRS.		REV. SIZE	
THIS DRAWING CONTAINS INFORMATION THAT IS PROPRIETARY TO MOLEX INC. AND SHOULD NOT BE USED WITHOUT WRITTEN PERMISSION.		CP C	

13 12 11 10 9 8 7 6 5 4 3 2 1

PLUG		RECEPTACLE	
PART NO.	ENG. NO.	PART NO.	ENG. NO.
03-06-2151	1625-15P	03-06-1152	1625-15R1
03-06-7155	1625-15P1BN	03-06-6152	1625-15R1BK
03-06-7152	1625-15P1BK	03-06-6155	1625-15R2
03-06-2152	1625-15P1	NOT TOOLED	1625-15R2BK
03-06-7151	1625-15PBK		
03-06-7153	1625-15PBN		
03-06-7154	1625-15PBU		

PLUG LEGEND:

1625-15P***

CIRCUIT SIZE

P = PLUG

BLANK = WITH MOUNTING EARS
I = WITHOUT EARS

COLOR:

BLANK = NATURAL COLOR
AM = AMBER BK = BLACK BU = BLUE
BN = BROWN GY = GRAY GN = GREEN
OR = ORANGE RD = RED YW = YELLOW

RECEPTACLE LEGEND:

1625-15R***

CIRCUIT SIZE

R = RECEPTACLE

1 = WITHOUT EARS
2 = WITH PREBENT EARS

COLOR:

BLANK = NATURAL COLOR
AM = AMBER BK = BLACK BU = BLUE
BN = BROWN GY = GRAY GN = GREEN
OR = ORANGE RD = RED YW = YELLOW

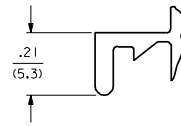

DETAIL 1

STANDARD MOUNTING EAR
SCALE 4:1

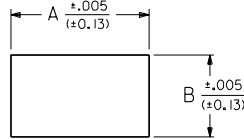
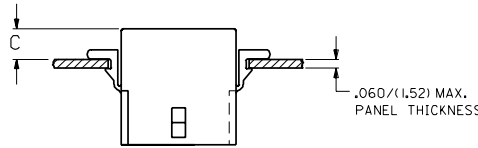

RECOMMENDED HOLE PATTERN

RECEP.	.930 (23.62)	.569 (14.45)	.22 (5.6)
PLUG	1.032 (26.21)	.620 (15.75)	.21 (5.3)
PART	DIM. A	DIM. B	DIM. C (STANDARD EAR)
			DIM. C (PREBENT EAR)

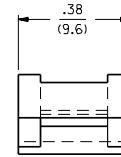

DETAIL 2

.062/(1.57) PREBENT MOUNTING EAR
(SCALE 4:1)

NOTES:

- MATERIAL: NYLON TYPE 6/6, 94V-2.
- THIS PART COMPLIES WITH MOLEX PRODUCT SPEC. 02-06.
- THIS HOUSING FOR USE WITH .062/(1.57) DIA. TERMINALS.
- WHERE DENOTED IN CHART, TOOLS ARE BUILT WITH PREBENT MOUNTING EARS PER DETAIL 2 AND SUPERSEDE ALL TOOLS PREVIOUSLY BUILT WITH THE STANDARD MOUNTING EARS.
- CIRCUIT I.D. NUMBERS ON HOUSING APPEAR ON PART FROM TOOLS BUILT AFTER 1/15/94.

N	SEE SHEET I	DIMENSIONS SHOWN (METRIC) INCH	▽=0	▽=0	REVISE ONLY ON CAD SYSTEM
M	SEE SHEET I	UNLESS OTHERWISE SPECIFIED			
L	SEE SHEET I	TOLERANCES ANGULAR ± .001			
Q2	SEE SHEET I				
Q1	SEE SHEET I				
Q	SEE SHEET I				
O	SEE SHEET I				
LTR.	REVISIONS				

INCH	METRIC
3 PLACES ± .010	---
2 PLACES ± .014	+ 0.25
1 PLACE ---	± 0.35

DRAFT WHERE APPLICABLE MUST REMAIN WITHIN DIMENSIONS

DRG. BY: CEP DWG. BY: RW
APP'D: RAS SCALE: 2:1
FILE NAME: S162515X3

TITLE: .062/(1.57) HOUSING; PLUG AND RECEPTACLE; 15 CKT. 145/(3.68) CTRS.

MOLEX INCORPORATED
U.S.A. 8052

PART NO. SD-1625-15*
SHEET NO. 3
DATE 7/18/88

THIS DRAWING CONTAINS INFORMATION THAT IS PROPRIETARY TO MOLEX INC. AND SHOULD NOT BE USED WITHOUT WRITTEN PERMISSION.