

13 12 11 10 9 8 7 6 5 4 3 2 1

PLUG

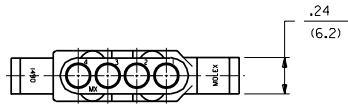

OPTIONAL MOUNTING EAR (2 PL.)
(STD. MOUNTING EAR SHOWN)
SEE DETAIL 3 OR 4

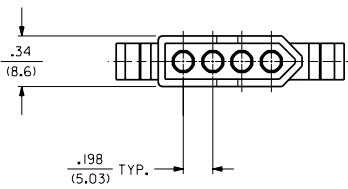
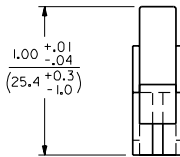
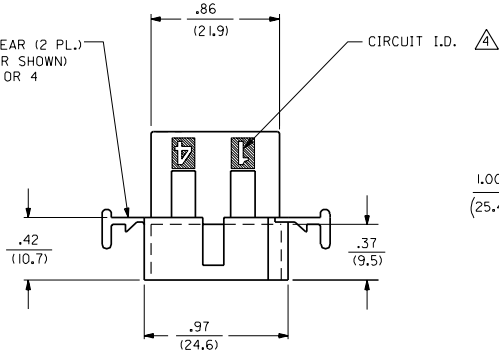

PLUG HOUSING

T	ADD -PIBU VERSION PER ECR #15 1537 10-21-83 RW
S	REVISE PER ECR U1 1686 CEC 8/9/91 RW
R1	ADD EDP'S & REVISE SUFFIXES, ECR U10854 CEC 4/24/91 RW
R	REV. LENGTH TOL. ECR #11 0685 5-22-91 RW
P	REV. & REDRAWN, ECR UB 1139 CEP 3-8-88 RW
MFG. SH. REV. LTR.	REVISIONS

DIMENSIONS SHOWN METRIC INCH		REVISION ONLY ON CAD SYSTEM													
UNLESS OTHERWISE SPECIFIED TOLERANCES ANGULAR ±.5°		TITLE													
<table border="1"> <tr> <th></th> <th>INCH</th> <th>METRIC</th> </tr> <tr> <td>3 PLACE</td> <td>± .010</td> <td>---</td> </tr> <tr> <td>2 PLACE</td> <td>± .014</td> <td>+ 0.25</td> </tr> <tr> <td>1 PLACE</td> <td>---</td> <td>± 0.35</td> </tr> </table>			INCH	METRIC	3 PLACE	± .010	---	2 PLACE	± .014	+ 0.25	1 PLACE	---	± 0.35	.093/(2.36) HOUSING, PLUG AND RECEPTACLE, 4 CKT., .198/(5.03) CTRS.	
	INCH	METRIC													
3 PLACE	± .010	---													
2 PLACE	± .014	+ 0.25													
1 PLACE	---	± 0.35													
DRAFT WHERE APPLICABLE MUST REMAIN WITHIN DIMENSIONS		MOLEX INCORPORATED													
DRWG. NO.	SD-1490-1	SHEET NO.	1 OF 3												
DATE	3/9/88	DATE	3/9/88												
FILE NAME	SD 1490X1	REV.	CP												
APP'D.	RAS	SCALE	2 : 1												

13 12 11 10 9 8 7 6 5 4 3 2 1

PLUG		RECEPTACLE	
PART NO.	ENG. NO.	PART NO.	ENG. NO.
03-09-2041	I490-P	03-09-1041	I490-R
03-09-2042	I490-P1	03-09-1042	I490-R1
03-09-7041	I490-PBK	03-09-6041	I490-RBK
03-09-7042	I490-P1BK	03-09-6042	I490-R1BK
PRELIMINARY	I490-P2	03-09-1043	I490-R2
03-09-3042	I490-P1BU	03-09-6043	I490-RBU
		03-09-6045	I490-RGN

LEGEND:

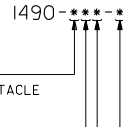

P = PLUG
R = RECEPTACLE

BLANK = WITH STANDARD EARS
1 = WITHOUT EARS
2 = WITH PREBENT EARS, PER DETAIL 4

COLOR: BLANK=NATURAL COLOR
AM=AMBER BK=BLACK BU=BLUE
BN=BROWN CY=GRAY GN=GREEN
OR=ORANGE RD=RED YW=YELLOW
BLANK = MATERIAL CODE A

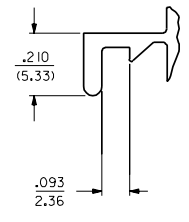

DETAIL 3
.093/(2.36) STANDARD MOUNTING EAR
(SCALE 4:1)

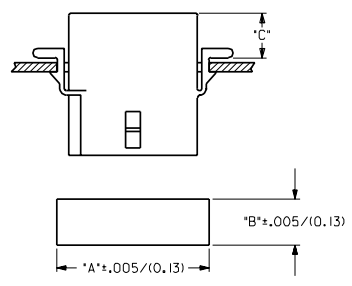

HOUSING	DIM. "A"	DIM. "B"	DIM. "C"
PLUG	1.131/(28.73)	.375/(9.52)	.36/(9.1)
RECEPTACLE	1.038/(26.36)	.312/(7.92)	.37/(9.4)

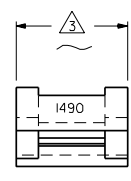

DETAIL 4
.093/(2.36) PREBENT MOUNTING EAR
(SCALE 4:1)

NOTES:

- MATERIAL CODES:
A = NYLON 6/6, 94V-2
- THIS PART COMPLIES WITH MOLEX PRODUCT SPEC. 02-09.
- FOR DIMENSION SEE SHEET 1 AND 2.
- CIRCUIT I.D. NUMBERS ON HOUSING APPEAR ON PARTS FROM TOOLS BUILT AFTER 8/7/91.

DIMENSIONS SHOWN METRIC INCH UNLESS OTHERWISE SPECIFIED TOLERANCES ANGULAR ±.04° TO		▽=0 ▼=0	REVISE ONLY ON CAD SYSTEM												
<table border="1"> <thead> <tr> <th></th> <th>INCH</th> <th>METRIC</th> </tr> </thead> <tbody> <tr> <td>3 PLACE</td> <td>± .010</td> <td>---</td> </tr> <tr> <td>2 PLACE</td> <td>± .014</td> <td>+ 0.25</td> </tr> <tr> <td>1 PLACE</td> <td>---</td> <td>± 0.35</td> </tr> </tbody> </table>			INCH	METRIC	3 PLACE	± .010	---	2 PLACE	± .014	+ 0.25	1 PLACE	---	± 0.35	MOLEX INCORPORATED SHEET NO. 3 DATE 3/10/88 U.S.A. 8052P	
	INCH	METRIC													
3 PLACE	± .010	---													
2 PLACE	± .014	+ 0.25													
1 PLACE	---	± 0.35													
DRAFT WHERE APPLICABLE MUST REMAIN WITHIN DIMENSIONS DRWG. BY CEP DW'D. BY RW APP'D. RAS SCALE 2:1		SEE CHART SD-I490- THIS DRAWING CONTAINS INFORMATION THAT IS PROPRIETARY TO MOLEX INC. AND SHOULD NOT BE USED WITHOUT WRITTEN PERMISSION. CP C													