





Messrs. Standard					
Product Specification	Model:	NMTG-F24160BFWHSEB-15	Rev. No.	Issued Date.	Page.
			A	May. 24, 06	1 / 22

**LIQUID CRYSTAL DISPLAY MODULE**  
**MODEL: NMTG-F24160BFWHSEB-15**  
**Customer's No.:**

Acceptance

*Microtips Technology Inc.*  
 12F. No.31 Lane 169, Kang Ning St., His-Chih,  
 Taipei Hsien, Taiwan, R.O.C.  
 FAX: 886-2-26958625

Approved and Checked by

Approved by	Checked by		Made by
			



*Microtips Technology Inc.*



Messrs. Standard					
Product Specification	Model:	NMTG-F24160BFWHSEB-15	Rev. No.	Issued Date.	Page.
			A	May. 24, 06	3 / 22

# Contents

1.	General Specifications .....	4
2.	Electrical Specifications .....	5
2.1	Absolute Maximum Ratings.....	5
2.2	DC Characteristics.....	5
2.3	Signal Timing Diagram .....	6
2.4	Timing Chart & Comparison of Display and Data .....	8
2.5	Power Supply ON/OFF Sequence.....	9
2.6	Lighting Specifications.....	10
3.	Optical Specifications .....	11
3.1	LCD Driving Voltage Recommended .....	11
3.2	Optical Characteristics .....	11
3.3	Definition of Viewing Angle and Optimum Viewing Area .....	12
3.4	Definition of Viewing Angle $\theta_r$ and $\theta_b$ .....	12
3.5	Definition of Contrast C.....	12
4.	I/O Terminal.....	13
4.1	Pin Assignment .....	13
4.2	Example of Power Supply .....	13
4.3	Block Diagram .....	14
5.	Reliability Test.....	15
5.1	Test Item.....	15
5.2	Judgment Standard.....	16
6.	Appearance Standards .....	17
6.1	Inspection Conditions .....	17
6.2	Definition of Applicable Zones .....	17
6.3	Standards.....	18
7.	Handling and Precautions.....	20
8.	Warranty:.....	21
9.	Dimensional Outlines.....	21



*Microtips Technology Inc.*

Messrs. Standard					
Product Specification	Model:	NMTG-F24160BFWHSEB-15	Rev. No.	Issued Date.	Page.
			A	May. 24, 06	4 / 22

The Microtips Customized LCD module, model: NMTG-F24160BFWHSEB-15 is compliant with RoHS

## 1. General Specifications

Operating Temperature	:	Min. -20°C ~ Max. 70°C
Storage Temperature	:	Min. -30°C ~ Max. 80°C
Dot Pixels	:	240 (W) x 160 (H) dots
Dot Size	:	0.23 (W) x 0.23 (H) mm
Dot Pitch	:	0.24 (W) x 0.24 (H) mm
Viewing Area	:	61.6 (W) x 42.5 (H) mm
Outline Dimensions	:	74.6* (W) x 54.1 (H) x 4.0 max. (D) mm
		* Not concerning EL pin and FPCB
Weight	:	N/A
LCD Type	:	FSTN/ Positive mode/ Transflective
Viewing Direction	:	6:00
Data Transfer	:	4-bit parallel data transfer
Backlight	:	EL backlight (Blue-Green)
Drawings	:	As attached drawings



*Microtips Technology Inc.*

Messrs. Standard					
Product Specification	Model:	NMTG-F24160BFWHSEB-15	Rev. No.	Issued Date.	Page.
			A	May. 24, 06	5 / 22

## 2. Electrical Specifications

### 2.1 Absolute Maximum Ratings

$V_{SS} = 0V$

Parameter	Symbol	Conditions	Min.	Max.	Units
Supply Voltage (Logic)	$V_{DD} - V_{SS}$	--	-0.3	7.0	V
Supply Voltage (LCD Drive)	$V_0 - V_{SS}$	--	-0.3	30.0	V
Input Voltage	$V_I$	--	-0.3	$V_{DD} + 0.3$	V

### 2.2 DC Characteristics

$T_a = 25^\circ C, V_{SS} = 0V$

Parameter	Symbol	Conditions	Min.	Typ.	Max.	Units	Note
Supply Voltage (Logic)	$V_{DD} - V_{SS}$	--	2.5	3.3	5.5	V	
Supply Voltage (LCD Drive)	$V_0 - V_{SS}$	--	15.0	--	30.0	V	
	$V_O - V_{SS}$	Shown in 3.1					V
High Level Input Voltage	$V_{IH}$	--	$0.8V_{DD}$	--	--	V	
Low Level Input Voltage	$V_{IL}$	--	--	--	$0.2V_{DD}$	V	
High Level Output Voltage	$V_{OH}$	$I_{OH} = -0.4mA$	$V_{DD} - 0.4$	--	--	V	
Low Level Output Voltage	$V_{OH}$	$I_{OH} = +0.4mA$	--	--	0.4	V	
Standby Current	$I_{STB}$	--	--	--	50	$\mu A$	1
Supply Current (1) Non-selection	$I_{DD1}$	--	--	--	2.0	mA	2
Supply Current (2) Selection	$I_{DD2}$	--	--	--	8.0	mA	3
Supply Current (3)	$I_0$	--	--	--	1.0	mA	4
Frame	$f_F$	Duty = 50%	65	70	75	Hz	

#### NOTES:

- $V_{DD} = +5.0V, V_0 = +30.0V, V_I = V_{SS}$ .
- $V_{DD} = +5.0V, V_0 = +30.0V, f_{XCK} = 8MHz$ , no-load,  $EI = V_{DD}$ . The input data is turned over by data taking clock (4-bit parallel input mode).
- $V_{DD} = +5.0V, V_0 = +30.0V, f_{XCK} = 8MHz$ , no-load,  $EI = V_{SS}$ . The input data is turned over by data taking clock (4-bit parallel input mode).
- $V_{DD} = +5.0V, V_0 = +30.0V, f_{XCK} = 8MHz, f_{LP} = 19.2kHz, f_{FR} = 80Hz$ , no-load. The input data is turned over by data taking clock (4-bit parallel input mode).



*Microtips Technology Inc.*

Messrs. Standard					
Product Specification	Model:	NMTG-F24160BFWHSEB-15	Rev. No.	Issued Date.	Page.
			A	May. 24, 06	6 / 22

### 2.3 Signal Timing Diagram

Segment Mode ( $V_{SS}=0V$ ,  $V_{DD}= 4.5\sim 5.5V$ ,  $V_0=15$  to 30 V, and  $T_a=-20$  to  $+85^\circ C$ )

Parameter	Symbol	Min.	Max.	Units	Condition
Shift clock period*	$t_{WLP}$	71	-	ns	$t_r, t_f \leq 10ns$
Shift clock "H" pulse width	$t_{WCKH}$	23	-	ns	
Shift clock "L" pulse width	$t_{WCKL}$	23	-	ns	
Data setup time	$t_{DS}$	10	-	ns	
Data hold time	$t_{DH}$	20	-	ns	
Latch pulse "H" pulse width	$t_{WLPH}$	23	-	ns	
Latch pulse rise to shift clock rise time	$t_{LS}$	51	-	ns	
Latch pulse fall to shift clock fall time	$t_{LH}$	51	-	ns	
Input signal rise time**	$t_r$	-	50	ns	
Input signal fall time**	$t_f$	-	50	ns	

Note :

\*Take the cascade connection into consideration.

\*\* $(t_{WLP} - t_{WCKH} - t_{WCKL})/2$  is the maximum in the case of high speed operation.

Segment Mode ( $V_{SS}=0V$ ,  $V_{DD}= 2.5\sim 4.5V$ ,  $V_0=15$  to 30 V, and  $T_a=-20$  to  $+85^\circ C$ )

Parameter	Symbol	Min.	Max.	Units	Condition
Shift clock period*	$t_{WLP}$	125	-	ns	$t_r, t_f \leq 11ns$
Shift clock "H" pulse width	$t_{WCKH}$	51	-	ns	
Shift clock "L" pulse width	$t_{WCKL}$	51	-	ns	
Data setup time	$t_{DS}$	30	-	ns	
Data hold time	$t_{DH}$	40	-	ns	
Latch pulse "H" pulse width	$t_{WLPH}$	51	-	ns	
Latch pulse rise to shift clock rise time	$t_{LS}$	51	-	ns	
Latch pulse fall to shift clock fall time	$t_{LH}$	51	-	ns	
Input signal rise time**	$t_r$	-	50	ns	
Input signal fall time**	$t_f$	-	50	ns	

Note :

\*Take the cascade connection into consideration.

\*\* $(t_{WLP} - t_{WCKH} - t_{WCKL})/2$  is the maximum in the case of high speed operation.



*Microtips Technology Inc.*

Messrs. Standard				Rev. No.	Issued Date.	Page.
Product Specification	Model:	NMTG-F24160BFWHSEB-15	A	May. 24, 06	7 / 22	

Common Mode ( $V_{SS}=0V$ ,  $V_{DD}= 2.5\sim 5.5V$ ,  $V_0=15$  to  $30 V$ , and  $T_a=-20$  to  $+85^\circ C$ )

Parameter	Symbol	Min.	Max.	Units	Condition
Shift clock period	$t_{WLP}$	250	-	ns	$t_r, t_f \leq 20ns$
Shift clock "H" pulse width	$t_{WCKH}$	15	-	ns	$V_{DD} = 5.0V \pm 10\%$
		30	-	ns	$V_{DD} = 2.5\sim 4.5V$
Data setup time	$t_{DS}$	30	-	ns	
Data hold time	$t_{DH}$	50	-	ns	
Input signal rise time**	$t_r$	-	50	ns	
Input signal fall time**	$t_f$	-	50	ns	

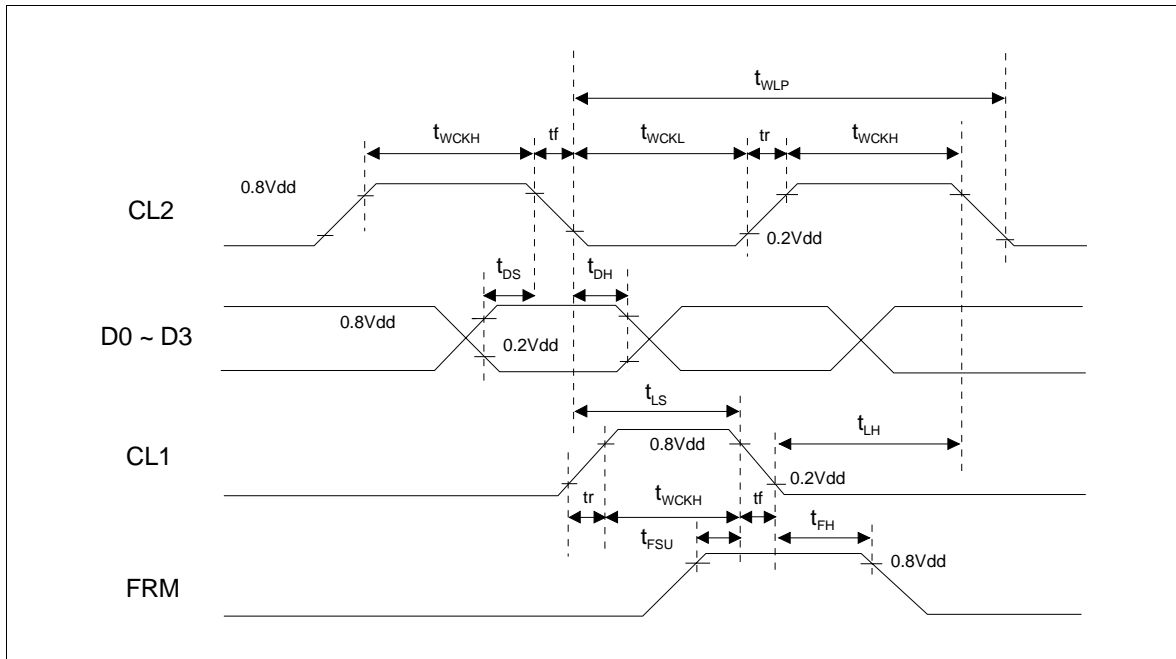

Signal Timing(1)



Microtips Technology Inc.

2.4 Timing Chart & Comparison of Display and Data

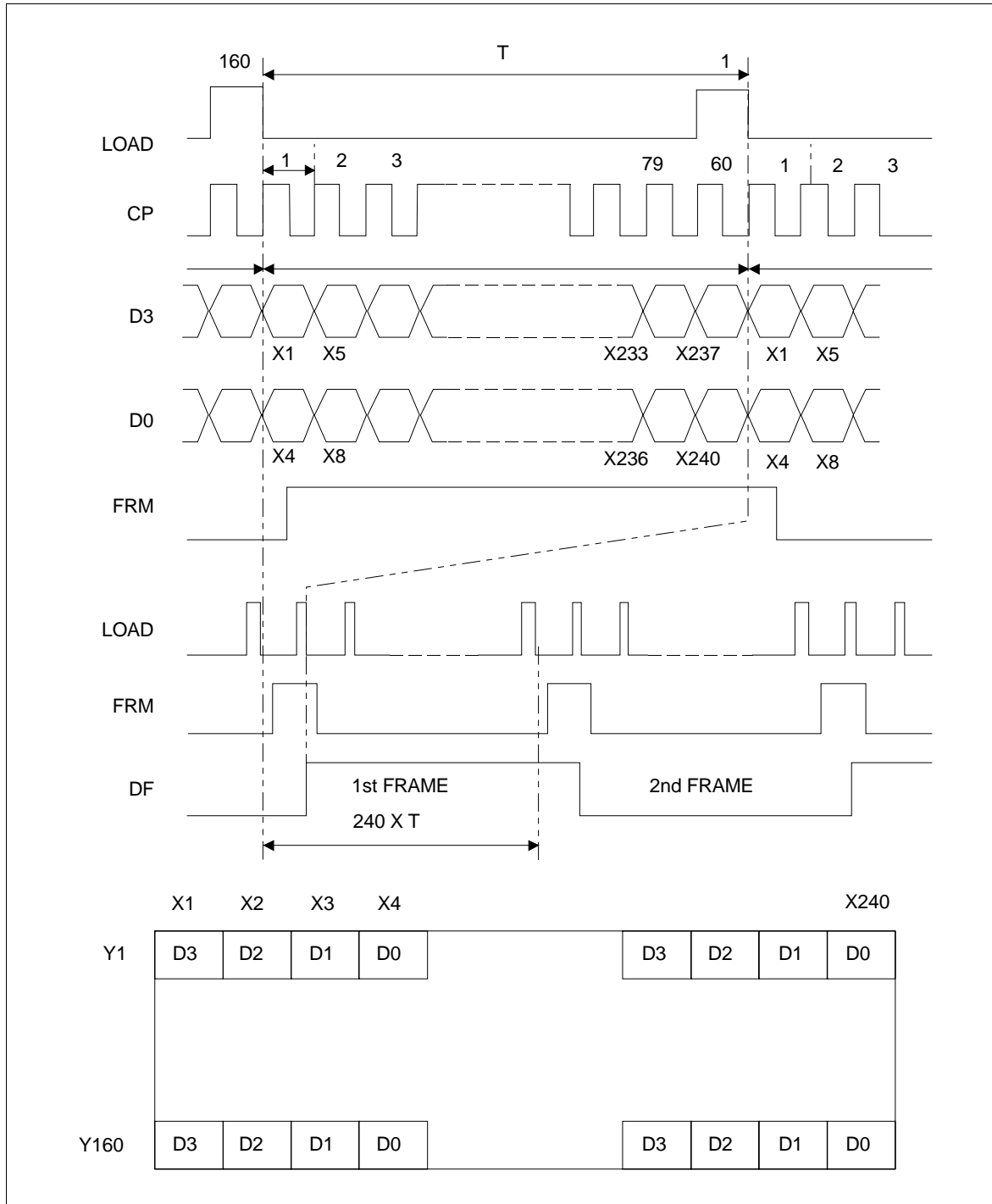

Signal Timing (2)



Microtips Technology Inc.



Messrs. Standard				Rev. No.	Issued Date.	Page.
Product Specification	Model:	NMTG-F24160BFWHSEB-15	A	May. 24, 06	9 / 22	

### 2.5 Power Supply ON/OFF Sequence

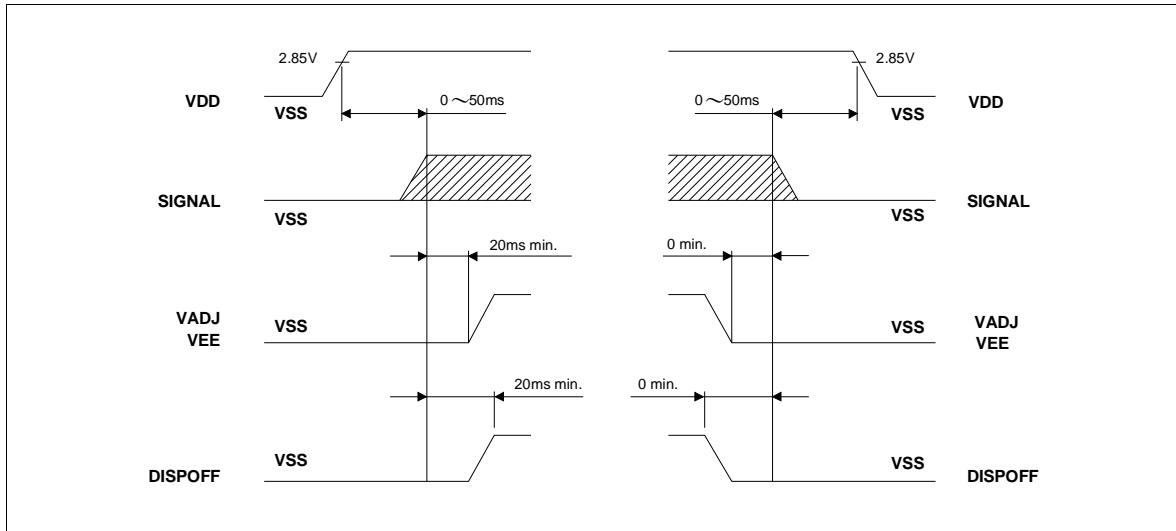

The missing pixels may occur when the LCM is driver beyond above power interface timing sequence.



*Microtips Technology Inc.*

Messrs. Standard					
Product Specification	Model:	NMTG-F24160BFWHSEB-15	Rev. No.	Issued Date.	Page.
			A	May. 24, 06	10 / 22

## 2.6 Lighting Specifications

### 2.6.1 Absolute Maximum Ratings

Item	Symbol	Condition	Min.	Typ.	Max.	Unit
Operating Voltage	$V_{MAX}$	Ta= 25°C	40	-	120	$V_{RMS}$
Frequency	$F_{MAX}$		50	-	1000	Hz

### 2.6.2 Operating Characteristics

Item	Symbol	Condition	Min.	Typ.	Max.	Unit
Operating Voltage	$V_{AC}$	Ta= 25°C	-	100	-	$V_{RMS}$
Frequency	$f_O$		-	400	-	Hz
Luminosity*	L	Ta= 25°C $V_{AC} = 100 V_{RMS}$ $f_O = 400Hz$	40	-	-	cd/m <sup>2</sup>
Current Consumption	I		-	-	0.2	mA/cm <sup>2</sup>
C.I.E.of 1931	X		0.15	0.18	0.21	-
	Y		0.35	0.38	0.41	-
Lifetime	-		-	2000	-	HRs
Color	-		Blue Green			

\*The luminosity is measured from the surface of EL only.

\*\* Time to half luminance.



*Microtips Technology Inc.*

Messrs. Standard					
Product Specification	Model:	NMTG-F24160BFWHSEB-15	Rev. No.	Issued Date.	Page.
			A	May. 24, 06	11 / 22

### 3. Optical Specifications

#### 3.1 LCD Driving Voltage Recommended

Parameter	Symbol	Conditions	Min.	Typ.	Max.	Units
LCD Driving Voltage Note 1	$V_O - V_{SS}$	Ta = -20 °C	-	21.11	-	V
		Ta = 25 °C	17.89	18.49	19.09	V
		Ta = 70 °C	-	16.28	-	V

Note 1 : Voltage (Applied actual waveform to LCD Module) for the best contrast. The range of minimum and maximum shows tolerance of the operating voltage. The specified contrast ratio and response time are not guaranteed over the entire range.

#### 3.2 Optical Characteristics

Ta=25 °C, 1/160 Duty, 1/13 Bias, (Note 4),  $\theta = 0^\circ$ ,  $\phi = -^\circ$

Parameter	Symbol	Conditions	Min.	Typ.	Max.	Units	
Contrast Ratio Note 1	C	$\theta = 0^\circ$ , $\phi = 0^\circ$	-	3.0	-	-	
Viewing Angle. CR $\geq$ 2 (Shown in 3.3)	Front-Back	$\theta_f - \theta_b$ , $\phi = 0^\circ$	+38	to	-29	deg.	
	Left-Right	$\theta_l - \theta_r$ , $\phi = 0^\circ$	+30	to	-32	deg.	
Response Time	Rise Note 2	$T_{ON}$	Ta = -20 °C	-	2010	4020	msec
	Decay Note 3	$T_{OFF}$		-	8200	16400	msec
	Rise Note 2	$T_{ON}$	Ta = 25 °C	-	140	280	msec
	Decay Note 3	$T_{OFF}$		-	255	510	msec
	Rise Note 2	$T_{ON}$	Ta = 70 °C	-	75		msec
	Decay Note 3	$T_{OFF}$		-	100		msec

Note 1 : Contrast ratio is defined as follows.

$$CR = L_{OFF} / L_{ON}$$

$L_{ON}$  : Luminance of the ON segments,  $L_{OFF}$  : Luminance of the OFF segments

Note 2 : The time that the luminance level reaches 90% of the saturation level from 0% when ON signal is applied.

Note 3 : The time that the luminance level reaches 10% of the saturation level from 100% when OFF signal is applied.

Note 4 : Definition of Driving Voltage  $V_D$ . Assuming that the typical driving waveforms shown below are applied to the LCD Panel at 1/A Duty - 1/B Bias ( A : Duty Number, B : Bias Number ). Driving voltage  $V_D$  is defined as follows:  $V_D = (V_{th1} + V_{th2}) / 2$

Vth1 : The voltage VO-P that should provide 50% of the saturation level in the luminance at the segment which the ON signal is applied to.

Vth2 : The voltage VO-P that should provide 50% of the saturation level in the luminance at the segment which the OFF signal is applied to.

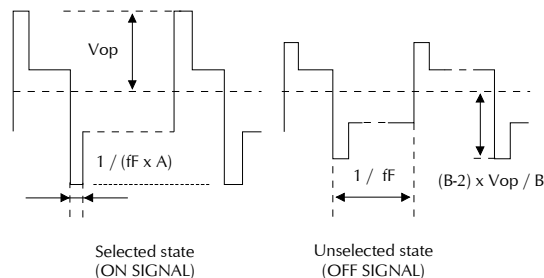

**Microtips Technology Inc.**

Messrs. Standard				Rev. No.	Issued Date.	Page.
Product Specification	Model:	NMTG-F24160BFWHSEB-15	A	May. 24, 06	12 / 22	

### 3.3 Definition of Viewing Angle and Optimum Viewing Area

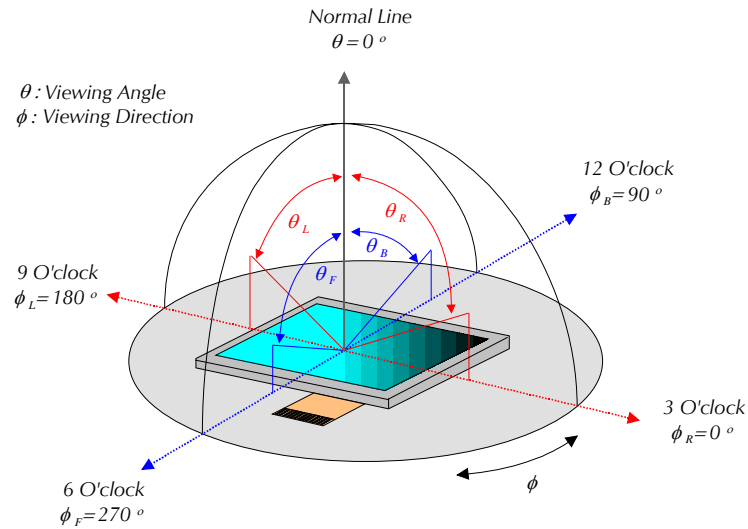

### 3.4 Definition of Viewing Angle $\theta_f$ and $\theta_b$

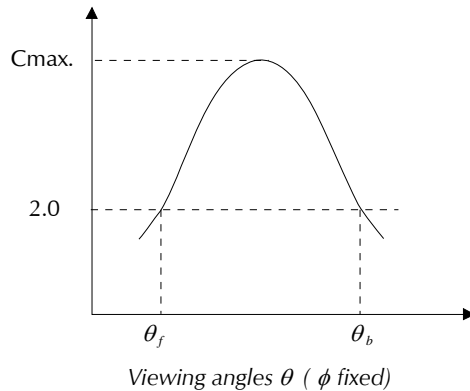

Optimum viewing angle with the naked eye and viewing angle  $\theta$  at Cmax. Above are not always the same.

### 3.5 Definition of Contrast C, $C = \text{Brightness of selected dot (B1)} / \text{Brightness of unselected dot (B2)}$

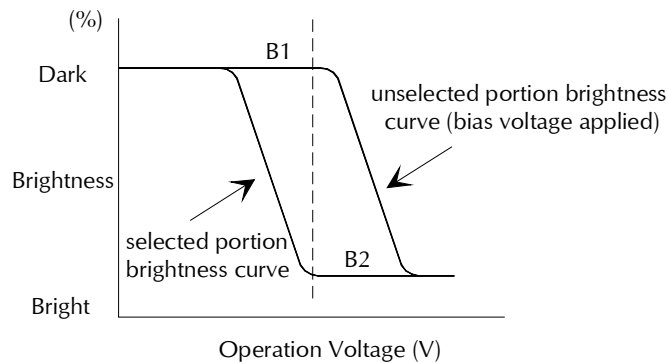

**Microtips Technology Inc.**

Messrs. Standard					
Product Specification	Model:	NMTG-F24160BFWHSEB-15	Rev. No.	Issued Date.	Page.
			A	May. 24, 06	13 / 22

#### 4. I/O Terminal

##### 4.1 Pin Assignment

No.	Symbol	Level	Function
1	V5	-	Power supply for LCD drive
2	V2	-	Power supply for LCD drive
3	V <sub>EE</sub>	-	Power supply for LCD drive
4	V <sub>DD</sub>	--	Power supply for logic system
5	FLM	I/O	Input/output for chip select or data of shift register
6	F_GND	-	Frame Ground.
7	Load	I	Latch pulse input/shift clock input for shift register
8	V <sub>SS</sub>	--	Ground pin connects to 0V
9	DF	I	AV converting signal input for LCD drive waveform
10	DISP	I	Control input pin for output deselect level
11	CP	I	Display data shift clock input for segment mode
12	V4	-	Power supply for LCD drive
13	V3	-	Power supply for LCD drive
14	DB3	I	Display Data
15	DB2	I	Display Data
16	DB1	I	Display Data
17	DB0	I	Display Data
18	N/C	--	No connection

##### EL pin out

No.	Symbol	Level	Function
1	EL 1	-	Power supply for EL B/L
2	EL 2	-	Power supply for EL B/L

##### 4.2 Example of Power Supply

It is recommended to apply a potentiometer for the contrast adjust due to the tolerance of the driving voltage and its temperature dependence.

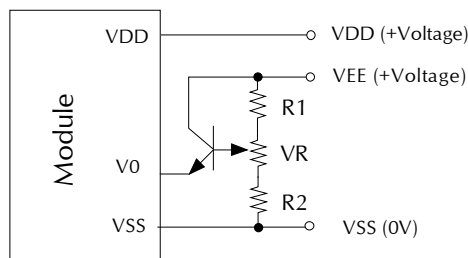

$$R1+R2+VR=10 \sim 20K$$

$$Tr = 2SA1202 \text{ or equivalent}$$



*Microtips Technology Inc.*

Messrs. Standard			
Product Specification	Model: NMTG-F24160BFWHSEB-15	Rev. No.	Issued Date.
		A	May. 24, 06
		Page. 14 / 22	

### 4.3 Block Diagram

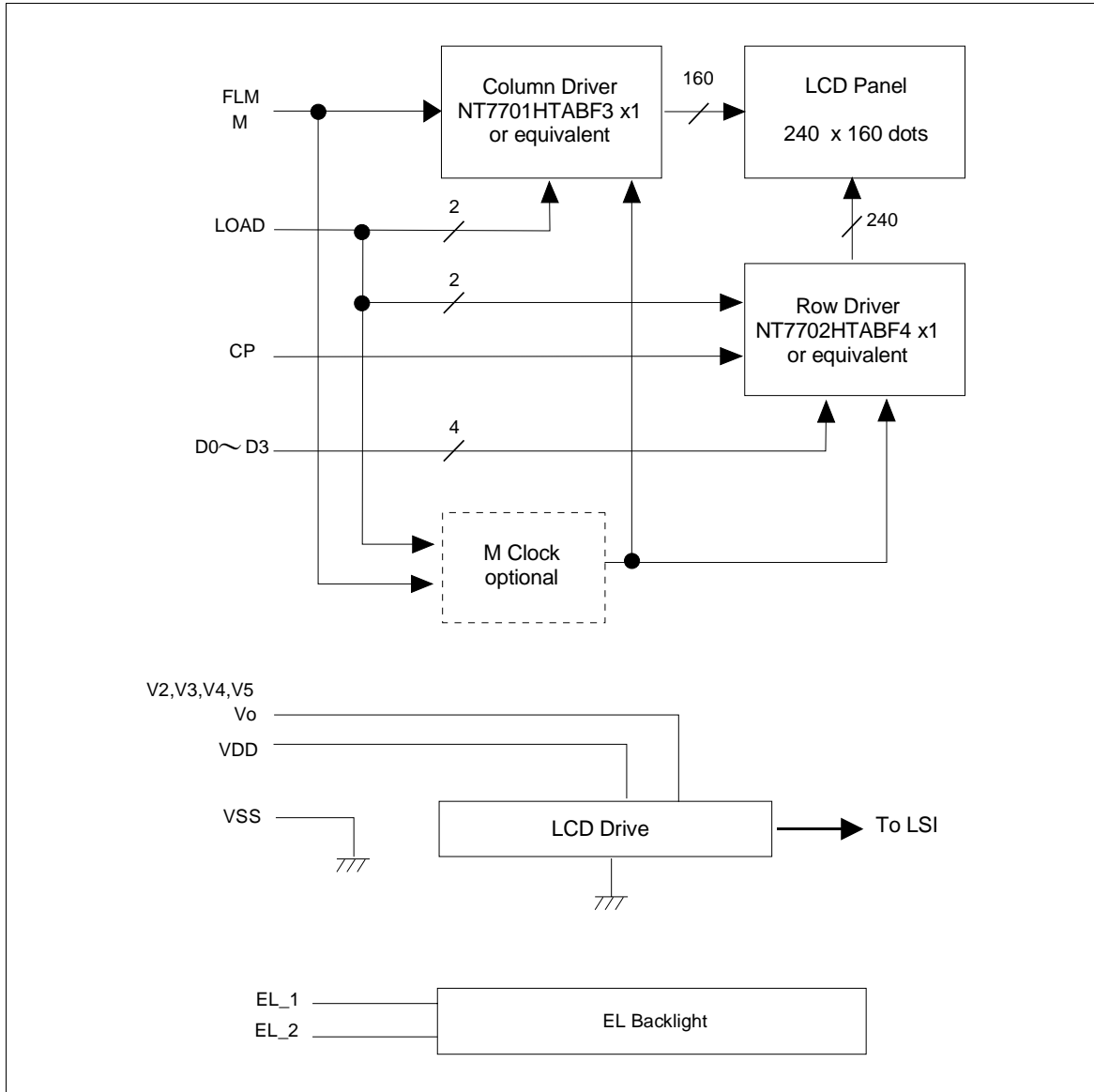

*Microtips Technology Inc.*

Messrs. Standard					
Product Specification	Model:	NMTG-F24160BFWHSEB-15	Rev. No.	Issued Date.	Page.
			A	May. 24, 06	15 / 22

## 5. Reliability Test

### 5.1 Test Item

No change on display and in operation under the following test condition.

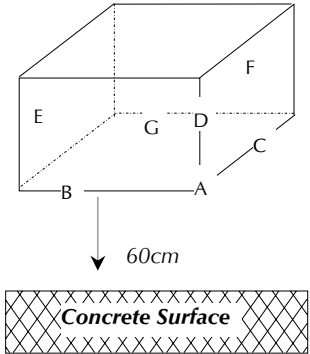
No.	Test Item	Description	Condition	Note
1.	High Temperature (Operation)	Durability test under long time high temperature with electrical stress (voltage, current)	70°C ± 2°C 96hrs	
2.	High Temperature (Storage)	Durability test under long time high temperature storage	80°C ± 2°C 96hrs	4
3.	Low Temperature (Operation)	Durability test under long time low temperature with electrical stress (voltage, current)	-20°C ± 2°C, 96hrs	3
4.	Low Temperature (Storage)	Durability test under long time low temperature storage	-30°C ± 2°C, 96hrs	3, 4
5.	Damp Proof Test	Durability test under long time high temperature and high humidity	40°C ± 2°C, 80% RH 96hrs	3, 4
6.	Vibration Test	Total fixed amplitude: 1.5mm Vibration frequency: 10~55Hz One cycle 60 seconds to 3 directions of X, Y, Z for each 15 minutes	--	5
7.	Drop Test	To be measured after dropping from 60cm high on the concrete surface in packing state.  <i>Dropping method corner dropping</i> A corner: once <i>Edge dropping</i> B, C, D edge: once <i>Face dropping</i> E, F, G face: once		

Note 1: Unless otherwise specified, tests will be conducted under the following condition,

Temperature : 25°C ± 2°C

Humidity : 65% ± 5%

Note 2: Unless otherwise specified, tests will be not conducted under functioning state.

Note 3: No dew condensation to be observed.

Note 4: The function test shall be conducted after 4 hours storage at the normal temperature and humidity after removed from the test chamber.

Note 5: Vibration test will be conducted to the product itself without putting it in a container.



**Microtips Technology Inc.**

Messrs. Standard					
Product Specification	Model:	NMTG-F24160BFWHSEB-15	Rev. No.	Issued Date.	Page.
			A	May. 24, 06	16 / 22

## 5.2 Judgment Standard

Failure Mode	Test Item							Judgment Standard
	1	2	3	4	5	6	7	
Orientation	*	*	*	*	*			No remarkable degradation of appearance under bias/ non-bias condition
Current Value (IAC)	*	*	*	*	*			No remarkable increase
Contrast	*		*	*	*			No remarkable poor contrast
Domain	*	*	*	*	*			Less than 20% of all dots have reverse tilt of more than on third of one dot area.
Bubble (Inside Cell)	*	*	*	*	*	*		As per "Appearance Standard" (Note. Including one which disappear after 25°C 2H)
Polarizer	*				*	*		As per "Appearance Standard" no remarkable appearance change
Glass Damage							*	As per "Appearance Standard"

Note.1. \* is strong linkage between Failure Mode and Test Item.

2. Number of Test Item should be referred to former page.

3. Judgment and Standard value should be fixed by other inspection standard and criteria samples.



*Microtips Technology Inc.*



Messrs. Standard					
Product Specification	Model:	NMTG-F24160BFWHSEB-15	Rev. No.	Issued Date.	Page.
			A	May. 24, 06	17 / 22

## 6. Appearance Standards

### 6.1 Inspection Conditions

The LCD shall be inspected under 40W white fluorescent light. The distance between the eyes and the sample shall be more than 30cm. All directions for inspecting the sample should be within 45° against perpendicular line.

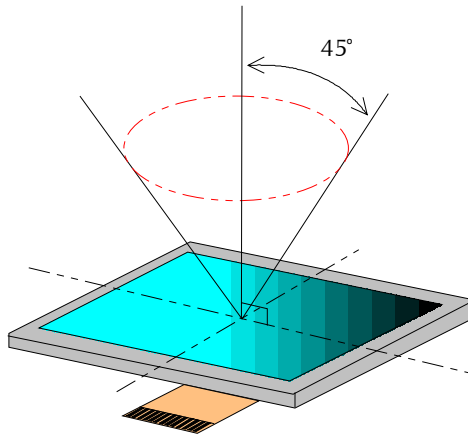

### 6.2 Definition of Applicable Zones

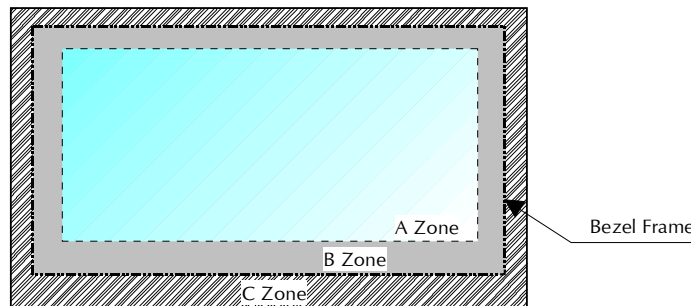

A Zone : Active display area  
 B Zone : Area from outside of "A Zone" to validity viewing area  
 C Zone : Rest parts  
 A Zone + B Zone = Validity viewing area



*Microtips Technology Inc.*

Messrs. Standard					
Product Specification	Model:	NMTG-F24160BFWHSEB-15	Rev. No.	Issued Date.	Page.
			A	May. 24, 06	18 / 22

### 6.3 Standards

No.	Parameter	Criteria																																																							
1.	Black and White Spots, Foreign Substances	<p>(1) Round Shape</p> <table border="1"> <thead> <tr> <th rowspan="2">Dimension (mm) \ Zone</th> <th colspan="3">Acceptable Number</th> </tr> <tr> <th>A</th> <th>B</th> <th>C</th> </tr> </thead> <tbody> <tr> <td><math>D \leq 0.2</math></td> <td>*</td> <td>*</td> <td>*</td> </tr> <tr> <td><math>0.2 &lt; D \leq 0.3</math></td> <td>3</td> <td>5</td> <td>*</td> </tr> <tr> <td><math>0.3 &lt; D \leq 0.4</math></td> <td>2</td> <td>3</td> <td>*</td> </tr> <tr> <td><math>0.4 &lt; D \leq 0.5</math></td> <td>0</td> <td>1</td> <td>*</td> </tr> <tr> <td><math>0.5 &lt; D</math></td> <td>0</td> <td>0</td> <td>*</td> </tr> </tbody> </table> <p><math>D = (\text{Long} + \text{Short})/2</math> *: Disregard</p> <p>(2) Line Shape</p> <table border="1"> <thead> <tr> <th rowspan="2">X (mm) \ Zone</th> <th rowspan="2">Y (mm) \ Zone</th> <th colspan="3">Acceptable Number</th> </tr> <tr> <th>A</th> <th>B</th> <th>C</th> </tr> </thead> <tbody> <tr> <td>--</td> <td><math>0.03 \geq W</math></td> <td>*</td> <td>*</td> <td>*</td> </tr> <tr> <td><math>2.0 \geq L</math></td> <td><math>0.05 \geq W</math></td> <td>3</td> <td>3</td> <td>*</td> </tr> <tr> <td><math>1.0 \geq L</math></td> <td><math>0.1 \geq W</math></td> <td>3</td> <td>3</td> <td>*</td> </tr> <tr> <td>--</td> <td><math>0.1 &lt; W</math></td> <td colspan="3">In the same way (1)</td> </tr> </tbody> </table> <p>X : Length Y: Width *: Disregard</p> <p>Total defects shall not exceed 5.</p>	Dimension (mm) \ Zone	Acceptable Number			A	B	C	$D \leq 0.2$	*	*	*	$0.2 < D \leq 0.3$	3	5	*	$0.3 < D \leq 0.4$	2	3	*	$0.4 < D \leq 0.5$	0	1	*	$0.5 < D$	0	0	*	X (mm) \ Zone	Y (mm) \ Zone	Acceptable Number			A	B	C	--	$0.03 \geq W$	*	*	*	$2.0 \geq L$	$0.05 \geq W$	3	3	*	$1.0 \geq L$	$0.1 \geq W$	3	3	*	--	$0.1 < W$	In the same way (1)		
Dimension (mm) \ Zone	Acceptable Number																																																								
	A	B	C																																																						
$D \leq 0.2$	*	*	*																																																						
$0.2 < D \leq 0.3$	3	5	*																																																						
$0.3 < D \leq 0.4$	2	3	*																																																						
$0.4 < D \leq 0.5$	0	1	*																																																						
$0.5 < D$	0	0	*																																																						
X (mm) \ Zone	Y (mm) \ Zone	Acceptable Number																																																							
		A	B	C																																																					
--	$0.03 \geq W$	*	*	*																																																					
$2.0 \geq L$	$0.05 \geq W$	3	3	*																																																					
$1.0 \geq L$	$0.1 \geq W$	3	3	*																																																					
--	$0.1 < W$	In the same way (1)																																																							
2.	Air Bubbles (between glass & polarizer)	<table border="1"> <thead> <tr> <th rowspan="2">Dimension (mm) \ Zone</th> <th colspan="3">Acceptable Number</th> </tr> <tr> <th>A</th> <th>B</th> <th>C</th> </tr> </thead> <tbody> <tr> <td><math>D \leq 0.3</math></td> <td>*</td> <td>*</td> <td>*</td> </tr> <tr> <td><math>0.3 &lt; D \leq 0.4</math></td> <td>3</td> <td>*</td> <td>*</td> </tr> <tr> <td><math>0.4 &lt; D \leq 0.6</math></td> <td>2</td> <td>3</td> <td>*</td> </tr> <tr> <td><math>0.6 &lt; D</math></td> <td>0</td> <td>0</td> <td>*</td> </tr> </tbody> </table> <p>*: Disregard</p> <p>Total defects shall not exceed 3.</p>	Dimension (mm) \ Zone	Acceptable Number			A	B	C	$D \leq 0.3$	*	*	*	$0.3 < D \leq 0.4$	3	*	*	$0.4 < D \leq 0.6$	2	3	*	$0.6 < D$	0	0	*																																
Dimension (mm) \ Zone	Acceptable Number																																																								
	A	B	C																																																						
$D \leq 0.3$	*	*	*																																																						
$0.3 < D \leq 0.4$	3	*	*																																																						
$0.4 < D \leq 0.6$	2	3	*																																																						
$0.6 < D$	0	0	*																																																						

To be continued.....



*Microtips Technology Inc.*

Messrs. Standard			
Product Specification	Model: NMTG-F24160BFWHSEB-15	Rev. No.	Issued Date.
		A	May. 24, 06
			Page. 19 / 22

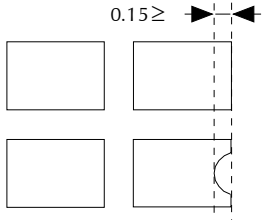
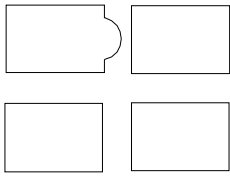
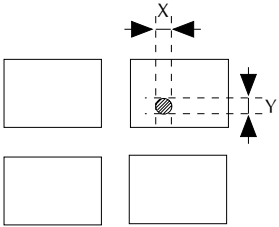
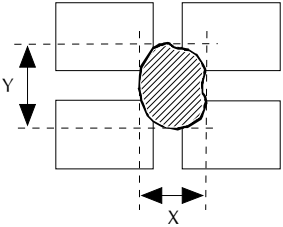
No.	Parameter	Criteria
3.	The Shape of Dot	<p>(1) Dot Shape (with Dent)</p>  <p>0.15 ≥</p> <p>As per the sketch of left hand.</p> <p>(2) Dot Shape (with Projection)</p>  <p>Should not be connected to next dot.</p> <p>(3) Pin Hole</p>  <p><math>(X+Y)/2 \leq 0.2\text{mm}</math> (Less than 0.1mm is no counted.)</p> <p>(4) Deformation</p>  <p><math>(X+Y)/2 \leq 0.2\text{mm}</math></p> <p>Total acceptable number: 1/dot, 5/cell (Defect number of (4): 1pc.)</p>
4.	Polarizer Scratches	Not to be conspicuous defects.
5.	Polarizer Dirts	If the stains are removed easily from LCDP surface, the module is not defective.
6.	Complex Foreign Substance Defects	Black spots, line shaped foreign substance or air bubbles between glass & polarizer should be 5pcs maximum in total.
7.	Distance between different Foreign Substance defects	$D \leq 0.2$ : 20mm or more $0.2 < D$ : 40mm or more



*Microtips Technology Inc.*

Messrs. Standard					
Product Specification	Model:	NMTG-F24160BFWHSEB-15	Rev. No.	Issued Date.	Page.
			A	May. 24, 06	20 / 22

## 7. Handling and Precautions

The Following precautions will guide you in handling our product correctly.

- 1 Liquid crystal display devices
  - 1.1 The liquid crystal display device panel used in the liquid crystal display module is made of plate glass. Avoid any strong mechanical shock. Should the glass break handle it with care.
  - 1.2 The polarizer adhering to the surface of the LCD is made of a soft material. Guard against scratching it.
- 2 Care of the liquid crystal display module against static electricity discharge.
  - 2.1 When working with the module, be sure to ground your body and any electrical equipment you may be using. We strongly recommend the use of anti static mats ( made of rubber ), to protect work tables against the hazards of electrical shock.
  - 2.2 Avoid the use of work clothing made of synthetic fibers. We recommend cotton clothing or other conductivity-treated fibers.
  - 2.3 Slowly and carefully remove the protective film from the LCD module, since this operation can generate static electricity.
- 3 When the LCD module alone must be stored for long periods of time:
  - 3.1 Protect the modules from high temperature and humidity.
  - 3.2 Keep the modules out of direct sunlight or direct exposure to ultra-violet rays.
  - 3.3 Protect the modules from excessive external forces.
- 4 Use the module with a power supply that is equipped with an over current protector circuit, since the module is not provided with this protective feature.
- 5 Do not ingest the LCD fluid itself should it leak out of a damaged LCD module. Should hands or clothing come in contact with LCD fluid, wash immediately with soap.
- 6 Conductivity is not guaranteed for models that use metal holders where solder connections between the metal holder and the PCB are not used. Please contact us to discuss appropriate ways to assure conductivity.



*Microtips Technology Inc.*

Messrs. Standard					
Product Specification	Model:	NMTG-F24160BFWHSEB-15	Rev. No.	Issued Date.	Page.
			A	May. 24, 06	21 / 22

## 8. Warranty:

This product has been manufactured to your company's specifications as a part for use in your company's general electronic products. It is guaranteed to perform according to delivery specifications. For any other use apart from general electronic equipment, we cannot take responsibility if the product is used in medical devices, nuclear power control equipment, aerospace equipment, fire and security systems, or any other applications in which there is a direct risk to human life and where extremely high levels of reliability are required. If the product is to be used in any of the above applications, we will need to enter into a separate product liability agreement.

- 1 We cannot accept responsibility for any defect, which may arise from additional manufacturing of the product (including disassembly and reassembly), after product delivery.
- 2 We cannot accept responsibility for any defect, which may arise after the application of strong external force to the product.
- 3 We cannot accept responsibility for any defect, which may arise due to the application of static electricity after the product has passed your company's acceptance inspection procedures.
- 4 We cannot accept responsibility for industrial property, which may arise through the use of your product, with exception to those issues relating directly to the structure or method of manufacturing of our product. Microtips-origin longer than one year from Microtips production.

## 9. Dimensional Outlines

- See the next page.....



*Microtips Technology Inc.*

Messrs. Standard		Rev. No.	Issued Date.	Page.
Product Specification	Model: NMTG-F24160BFWHSEB-15	A	May. 24, 06	22 / 22

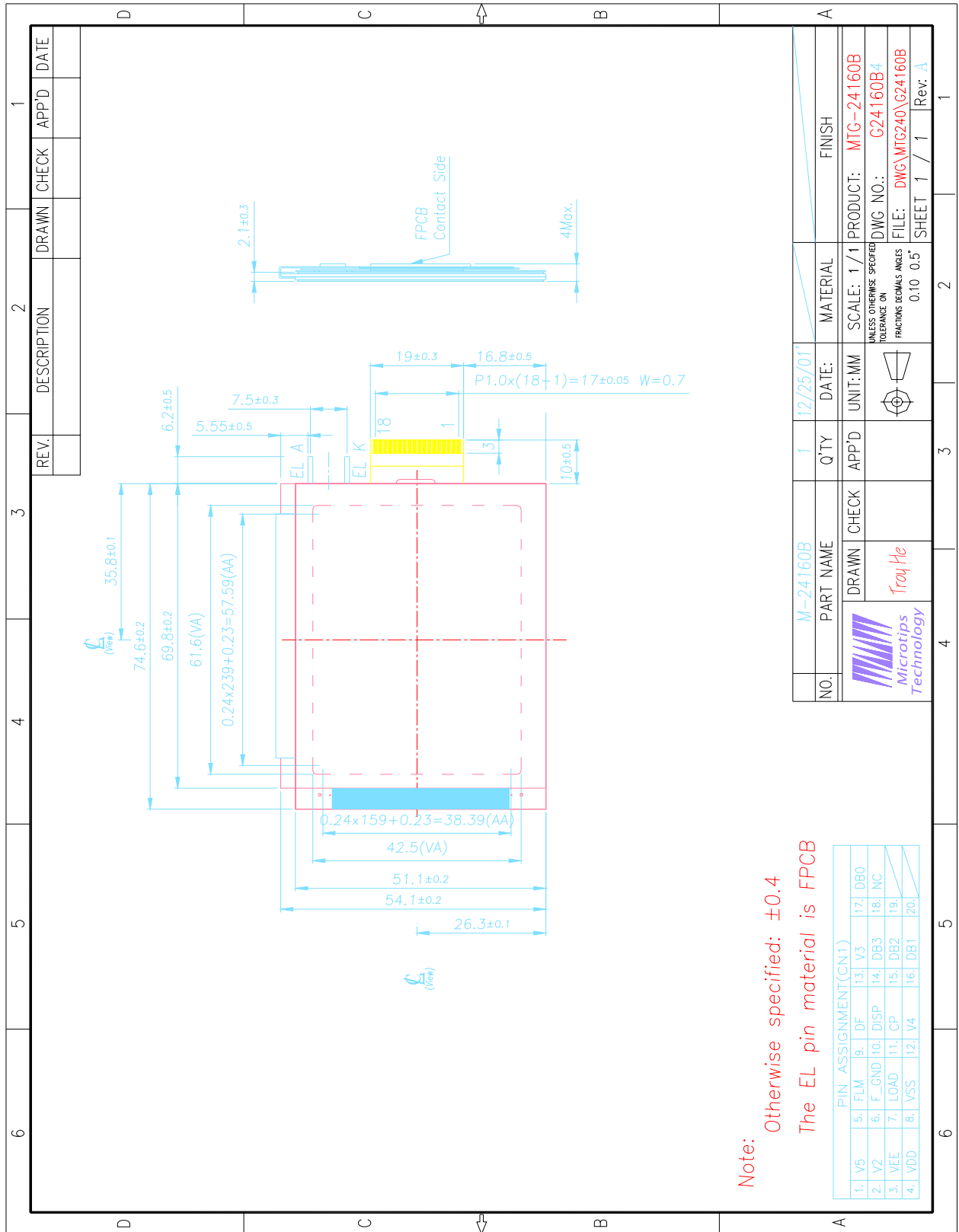

Microtips Technology Inc.