

Backlight and Flash Driver in QFN 3mm x 3mm

FEATURES

- Output current up to 500mA for Flash LED
- Up to 94% efficiency in 1x mode
- Triple mode 1x, 1.5x and 2x charge pump
- Built-in current setting DAC
- SP7682 - I²C serial interface
- SP7682A – Single Line Programmable Serial Interface
- 2.4MHz switching frequency
- Flash LED output current adjustable in 10mA steps to 500mA
- Backlight LED output current adjustable in 0.5mA steps to 31.5mA
- Power-saving shutdown mode of 1µA
- Time Out function to protect the LED in Flash mode (2s)
- Thermal shutdown protection
- Built-in over-voltage and over-current protection
- Automatic soft start limits in-rush current
- Lead Free, RoHS Compliant Packaging:
Space saving 16-pin 3X3mm QFN package

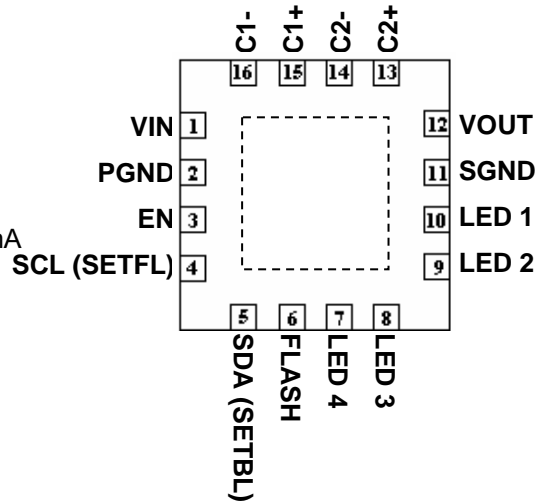

DESCRIPTION

The SP7682 or SP7682A provides a complete LED backlight and flash solution that is designed to drive 4 low current LEDs for backlighting and a single channel high current output for a LED flash. The SP7682 and SP7682A have serial interfaces that can program the backlight LED current in steps of 0.5mA up to 31.5mA and flash LED current in steps of 10mA up to 500mA. The SP7682A uses two single line serial interfaces for programming the backlight current and flash current. The SP7682 uses an I²C serial interface which also allows programming active, standby and shutdown states, selecting flash timeout periods and switching individual LEDs for the backlight. The data is loaded into internal registers upon power up and stored while in shutdown. When the chip is enabled, the stored values set the LED currents. The SP7682/SP7682A automatically detects 1x, 1.5x or 2x operation for optimal efficiency.

TYPICAL APPLICATION CIRCUIT

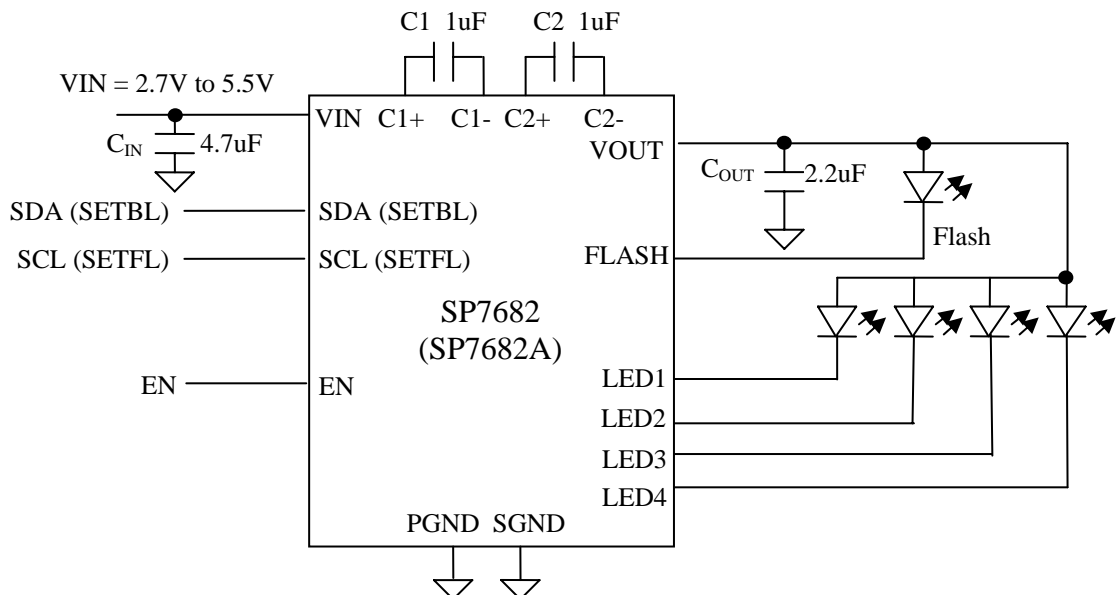



ABSOLUTE MAXIMUM RATINGS

These are stress ratings only and functional operation of the device at these ratings or any other above those indicated in the operation sections of the specifications below is not implied. Exposure to absolute maximum rating conditions for extended periods of time may affect reliability.

V_{CC}, Enable, SCL, SDA, V_{FLASH}, V_{LED}.....-0.3V to 6.0V
 Power Dissipation.....Internally limited¹
 Storage Temperature.....-65 °C to 150 °C
 Junction Temperature.....-40°C to +125°C
 ESD @ LED pins.....+/-4kV HBM
 ESD all other pins.....+/-2kV HBM

ELECTRICAL SPECIFICATIONS

Unless otherwise specified: V_{IN} =3.6V, C_{IN}=4.7uF, C_{OUT}=2.2uF, C_{FLY}=1uF, T_A = -40°C to +85°C, T_J=-40°C to +125°C.
Bold values apply over the full operating temperature range (-40°C to 85°C).

PARAMETER	MIN	TYP	MAX	UNITS	CONDITIONS
Operating VIN Range	2.7		5.5	V	
Operating Input Current		2		mA	
Quiescent Current		25		μA	Standby Mode
Shutdown Supply Current		0.01	1	μA	V _{EN} = 0V (shutdown), T _a = 25°C
I _{LED} Voltage for DAC=000000			0	mA	Measure LED1-LED4 and FLASH pins
I _{LED} for DAC=000001		0.5		mA	Measure current into LED1-LED4
I _{LED} for DAC=111111	30.2	31.5	34.8	mA	Measure current into LED1-LED4
I _{FLASH} for DAC=000001		10		mA	Measure current into FLASH
I _{FLASH} for DAC=110010	465	500	535	mA	Measure current into FLASH
Current DAC Resolution		6		Bit	
Backlight Current DAC LSB		0.5		mA	
Flash Current DAC LSB		10		mA	
DAC Current Accuracy	-7		7	%	5mA < I _{LED} < 30mA, 80mA < I _{FLASH} < 500mA
Switching Frequency	1.9	2.4	2.9	MHz	
Equivalent Resistance, 1x mode		1.0	1.8	Ohm	I _{out} =200mA
Equivalent Resistance, 1.5x mode		10		Ohm	I _{out} =80mA
Equivalent Resistance, 2x mode		8		Ohm	I _{out} =500mA
LEDx Pin dropout voltage			0.25	V	I _{LED} =20mA, measure mode switching
FLASH Pin dropout voltage			0.25	V	I _{FLASH} =200mA, measure mode switching
Thermal Regulation			0.01	%/°C	
Thermal Shutdown Die Temperature	150	160	170	°C	Driver turns off
Thermal Shutdown Hysteresis		20		°C	Driver turns on again
Over-current Protection	0.7		1.2	A	V _{out} =0V
Over-voltage protection	5.4		6.0	V	V _{out} open
Settle time (T _S) after last count			100	μs	To 1x mode from STANDBY mode
SDA, SCL, SETB, SETFL input logic low voltage			0.4	V	
SDA, SCL, SETB, SETFL input logic high voltage	1.6			V	
Turn-off time (T _{OFF}) into shutdown			50	μs	EN pin high to low
Time Duration before standby, SP7682	2	4	6	s	TD0=TD1=0V, I _{FLASH} >I _{THRESHOLD} (defined by bits TOUT0, TOUT1)
Time Duration before standby, SP7682A	1	2	3	s	I _{FLASH} >I _{THRESHOLD} = 230mA
Enable logic low voltage			0.4	V	Driver shutdown
Enable logic high voltage	1.6			V	Driver enabled

PARAMETER	SYMBOL	MIN	TYP	MAX	UNITS	CONDITIONS
Serial Clock Frequency	f _{SCL}			400	kHz	
Bus Free Time Between a STOP and a START	t _{BUF}	1.3			µs	
Hold Time, Repeated START Condition	t _{HD,STA}	0.6			µs	
Repeated START Condition Setup Time	t _{SU,STA}	0.6			µs	
STOP Condition Setup Time	t _{SU,STO}	0.6			µs	
Data Hold Time	t _{HD,DAT(OUT)}	225		900	ns	
Input Data Hold Time	t _{HD,DAT(IN)}	0		900	ns	
Data Setup Time	t _{SU,DAT}	100			ns	
SCL Clock Low Period	t _{LOW}	1.3			µs	
SCL Clock High Period	t _{HIGH}	0.6			µs	
Rise Time of Both SDA and SCL Signals, receiving	t _R	20+ 0.1Cb		300	ns	(Notes2, 3)
Fall Time of Both SDA and SCL Signals, Receiving	t _F	20+ 0.1Cb		300	ns	(Note2, 3)
Fall Time of SDA Transmitting	t _{F, TX}	20+ 0.1Cb		250	ns	(Note2, 3, 4)
Pulse Width of Spike Suppressed	t _{SP}	0		50	ns	(Note5)
Capacitive Load for Each Bus Line	Cb	400		400	pF	(Note 2)
I ² C startup time after UVLO clears	t _{SRT}	1		1	µs	(Note 2)

Note 1: All parameters tested at T_A=25 °C. Specifications over temperature are guaranteed by design.

Note 2: Guaranteed by design.

Note 3: Cb = total capacitance of one bus line in pF. t_R and t_F measured between 0.3 x VDD and 0.7 x VDD.

Note 4: I_{SINK} ≤6mA. Cb =total capacitance of one bus line in pF. t_R and t_F measured between 0.3 x V_{DD} and 0.7 V_{DD}.

Note5: Input filters on the SDA and SCL inputs suppress noise spikes less than 50ns.

SP7682A: SINGLE LINE PROGRAMMABLE SERIAL INTERFACE SPECIFICATIONS

PARAMETER	SYMBOL	MIN	TYP	MAX	UNITS	CONDITIONS
SET_BL, SET_FL logic low threshold	V _{IL}		0.4		V	
SET_BL, SET_FL logic high threshold	V _{IH}	1.6			V	
SET_BL, SET_FL logic low time	t _{LO}	0.5		250	µs	V _{SET_BL} < 0.4V
SET_BL, SET_FL logic high time	t _{HI}		0.5		µs	V _{SET_BL} > 1.6V
SET_BL shutdown delay	t _{SHDN}	225	500	800	µs	V _{SET_BL} < 0.4V
SET_FL shutdown delay	t _{SHDN}	325	500	700	µs	V _{SET_FL} < 0.4V

PIN #	PIN NAME	DESCRIPTION
1	V _{IN}	Power supply input. Place a 4.7uF decoupling capacitor next to this pin.
2	PGND	Power ground pin.
3	EN	Enable/Shutdown (Logic high = enable, logic low = shutdown). Used to immediately disable the driver and reset the output current level.
4, 5	SCL, SDA (SP7682)	These pins connect to the I ² C bus. Multiple functions can be programmed through his interface.
4	SETFL (SP7682A)	Used to serially program the Flash LED current
5	SETBL (SP7682A)	Used to serially program the Backlight LED's output current
6	FLASH	High current internal current source. Connect a high brightness LED between this pin and V _{OUT} . The value of the current can be programmed via the I ² C interface between 0mA and 500mA with 10mA increments. During operation this pin is monitored for dropout. When dropout condition detected the charge pump increases operation mode from 1x to 1.5x to 2x. If the FLASH current is set to above the maximum threshold the time-out protection circuit is activated. After the maximum time of constant operation, FLASH current is reduced to zero.
7,8,9, 10	LED1- LED4	Internal current source for LCD backlight. Connect an LED between each of these pins and V _{OUT} . The value of the current can be programmed via the I ² C interface between 0mA and 32mA with 0.5mA increments. During operation this pin is monitored for dropout. When dropout condition detected the charge pump increases operation mode from 1x to 1.5x to 2x. If any of the LEDs are not used connect the corresponding pin to Vout.
11	SGND	Signal ground pin.
12	VOUT	Output voltage of the internal charge pump. Connect the LEDs between this pin and the corresponding internal current source. Connect a 2.2uF capacitor between VOUT and PGND.
13,14, 15,16	C2+, C2- C1+, C1-	Connect external flying capacitors between these pins.
-	Thermal Pad	Connect thermal pad to PGND pin.

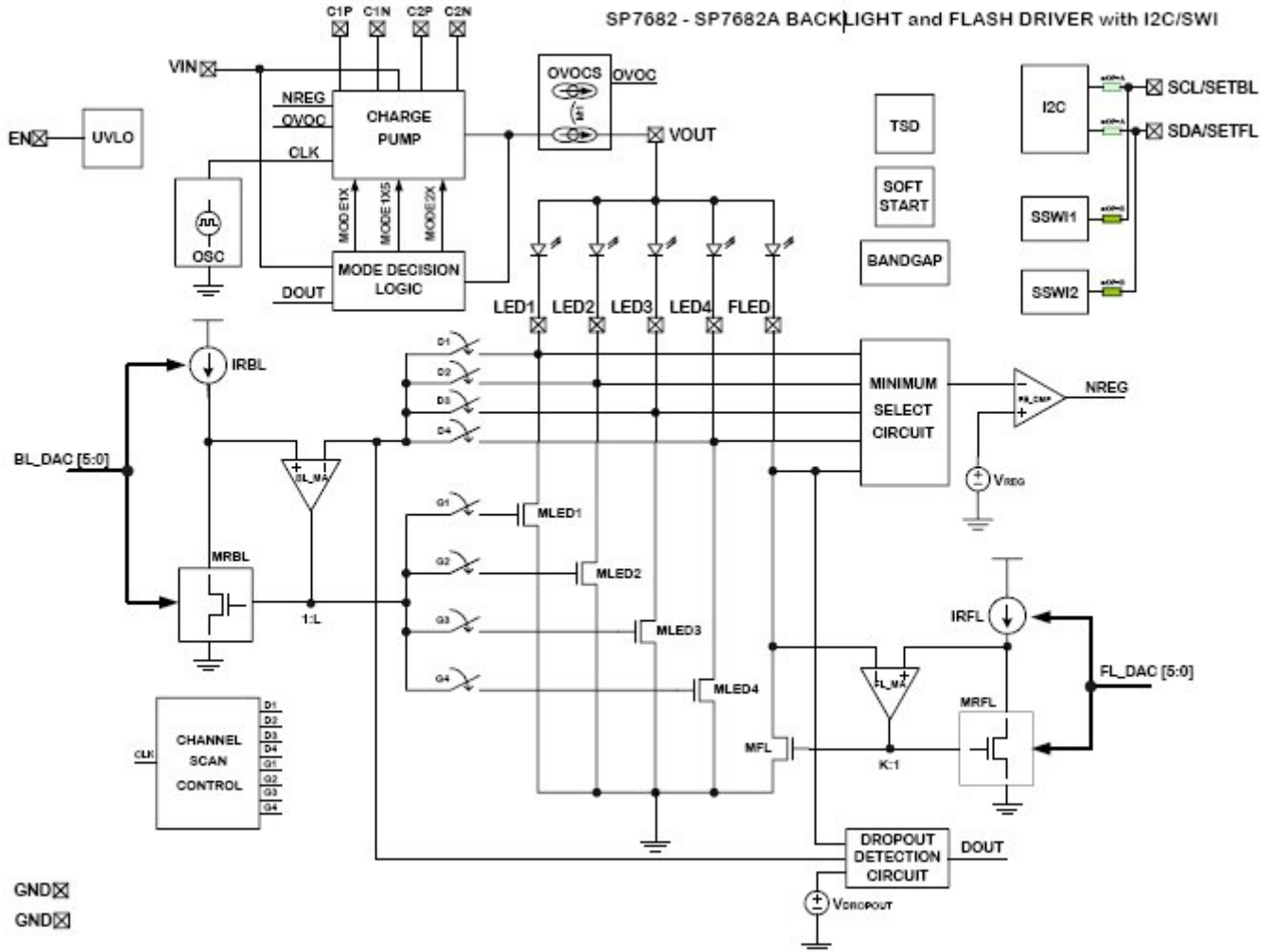



The SP7682 and SP7682A are charge pump based backlight and flash LED drivers with I²C and serial single wire interface (SWI) control respectively. The SP7682 family provides very accurate current drive capability for up-to four backlight LED channels and a flash LED. The backlight LED current can be set through a serial interface controlled 6-bit current DAC with 0.5mA steps, up to 31.5mA. Similarly, FLASH LED current is set thru a serial interface controlled 6-bit current DAC with 10mA steps, up to 500mA.

Backlight and Flash current loops make sure that the corresponding output currents at each individual LED output are regulated to their DAC set current values. The inherent decision and control logic decides the operation mode of the "gear-box" charge pump to maximize overall efficiency. In order to decide on the most efficient operation mode for the charge pump, the decision and control logic observes the battery voltage, output voltage, load current, dropout voltage, over-voltage, over-current conditions and in-regulation feedback signals and forces the charge pump to operate in one of the 1x, 1.5x and 2x modes and dynamically switches between modes to maximize overall efficiency.

The charge pump used in the heart of the design is a regulated charge pump and regulates the minimum of the LEDx outputs and FLASH output to be 350mV typical. Regulated output voltage depends on the forward voltage drop of the external LEDs used. The

charge pump switches at a high frequency of 2.4MHz which allows tiny 1uF external capacitors to be used as flying capacitors.

When any of the LED outputs or the FLASH output voltage drops below the "dropout" voltage (200mV typical), the charge pump decides to switch up to a less efficient mode, i.e. in 1x mode it switches to 1.5x mode, in 1.5x mode it switches to 2x mode. This switching to a less efficient mode guarantees the part to sustain LED currents in regulation. For the decision to switch back to a more efficient mode, the mode decision logic uses battery voltage, output voltage and load current information and relies on preset margins on the mode switching comparator thresholds.

The FLASH channel can be used in torch mode as well as in Flash time-out mode. When used for a momentary Flash output, it is recommended to activate the I²C control for timeout. Once the I²C timeout is activated and for as long as the Flash is active, the SP7682 charge pump will operate in 2x mode in order to provide the continuous voltage and high current needed for Flash. For the SP7682A, which uses the single wire interface, the Flash channel will be in 2x mode whenever the Flash current is at least 230mA.

The SP7682 and SP7682A are furnished with under-voltage lockout, current limit, thermal shutdown and over voltage protection features.

TYPICAL PERFORMANCE CHARACTERISTICS

V_{IN} = 3.6V, Typical Application Circuit, T_A = 25°C unless otherwise noted.

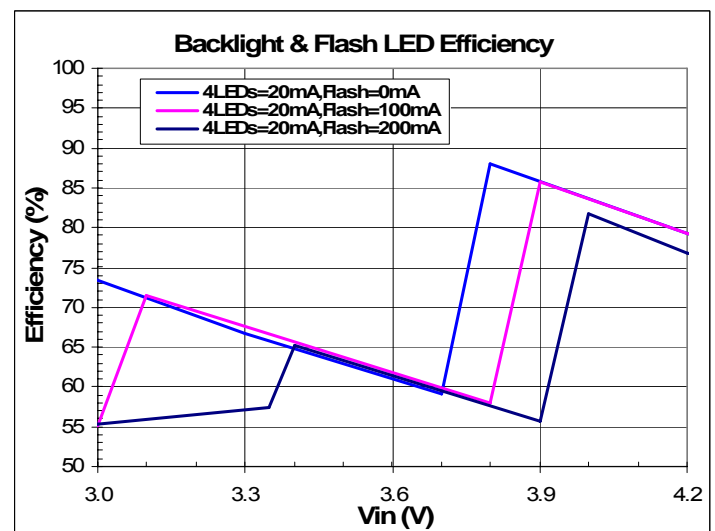
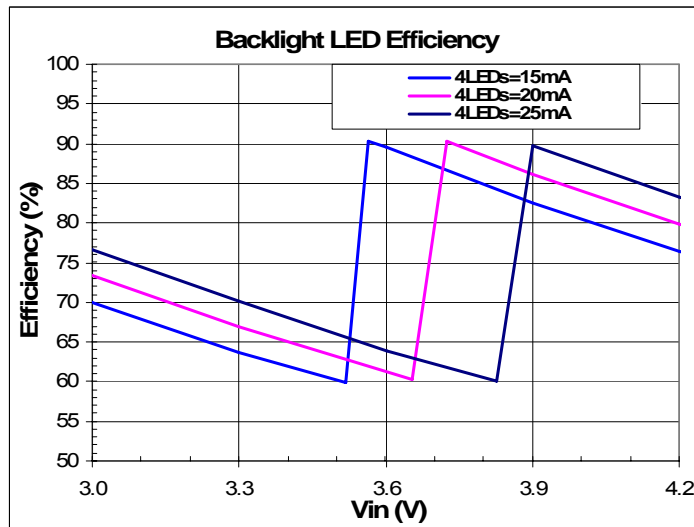
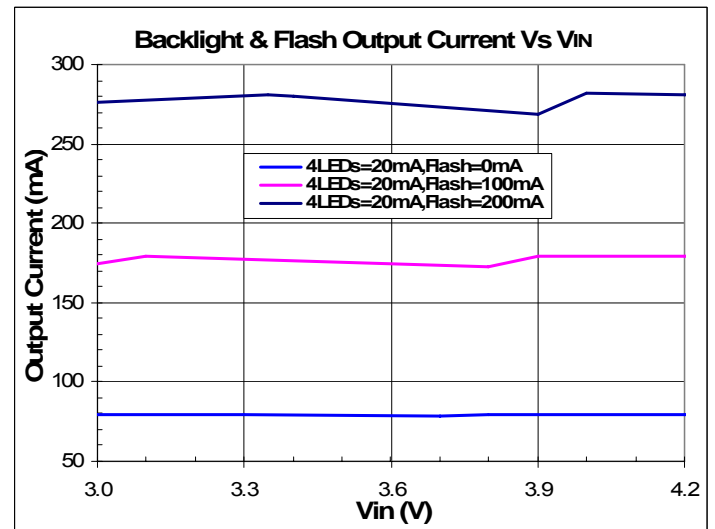
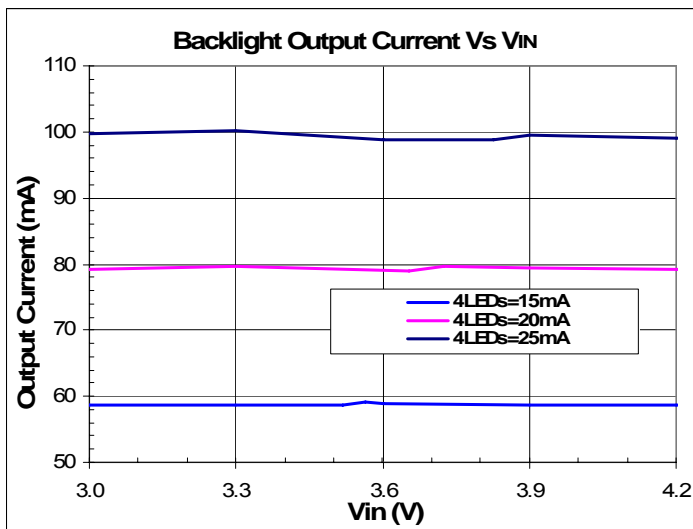
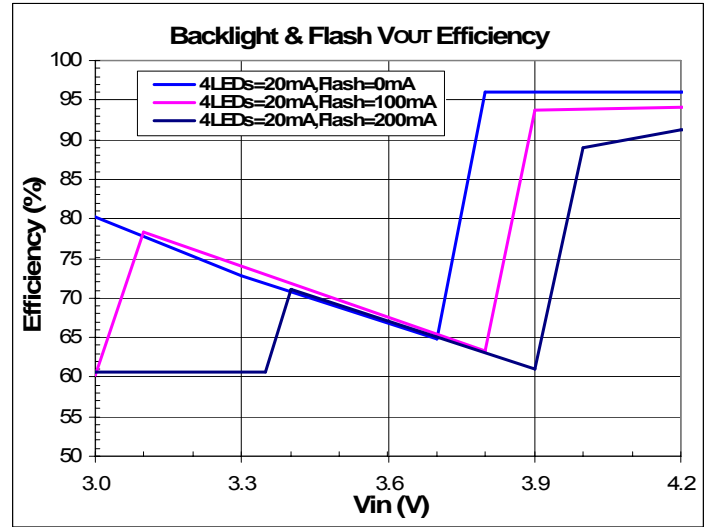
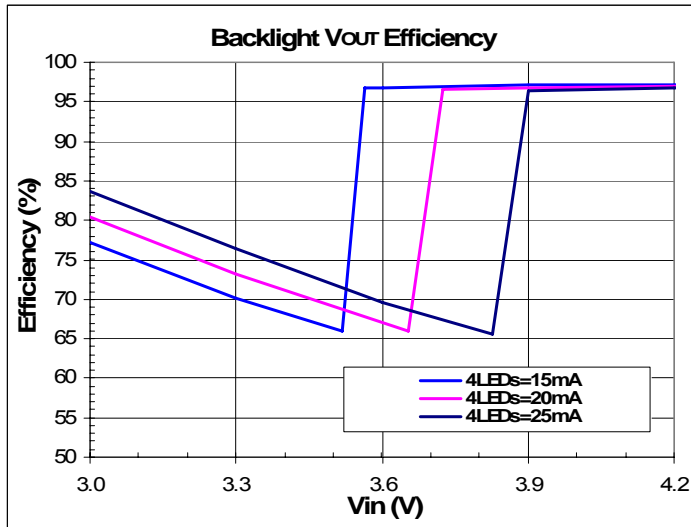

TYPICAL PERFORMANCE CHARACTERISTICS

V_{IN} = 3.6V, Typical Application Circuit, T_A = 25°C unless otherwise noted.

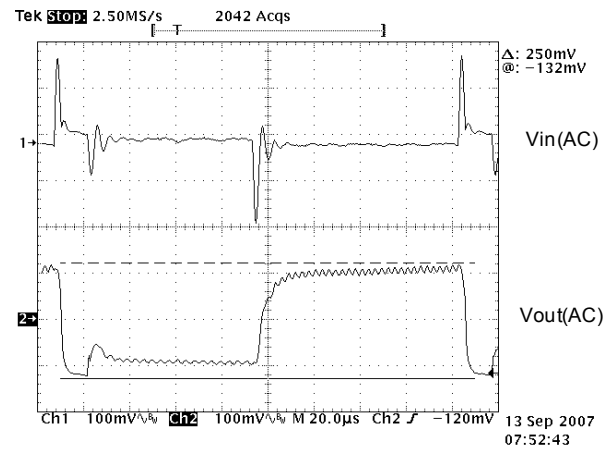
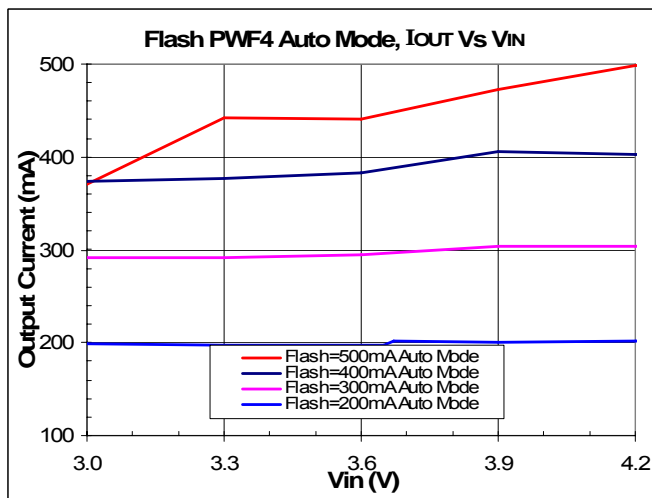
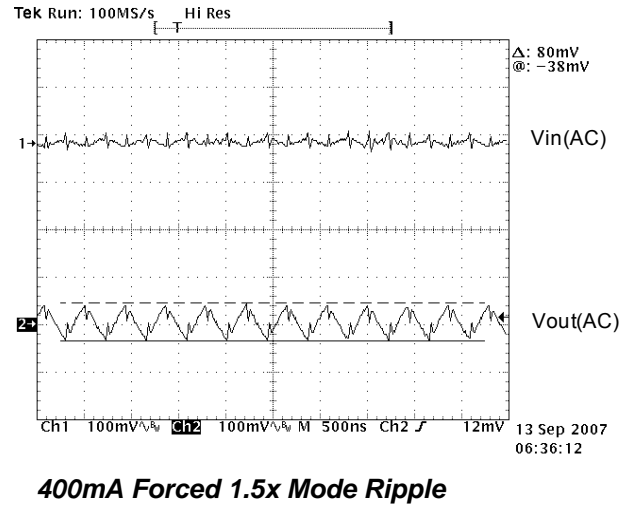
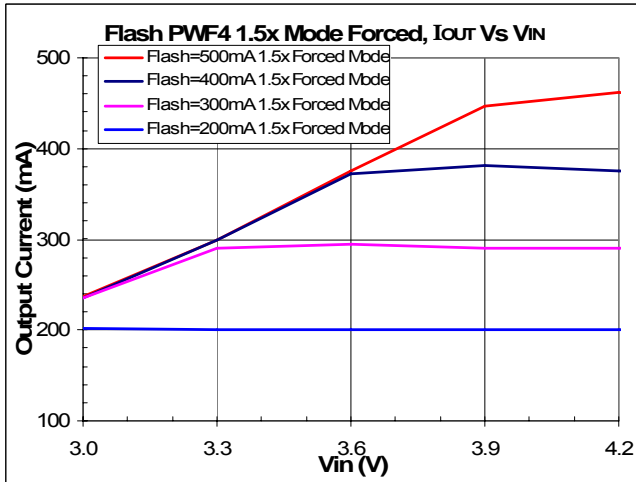
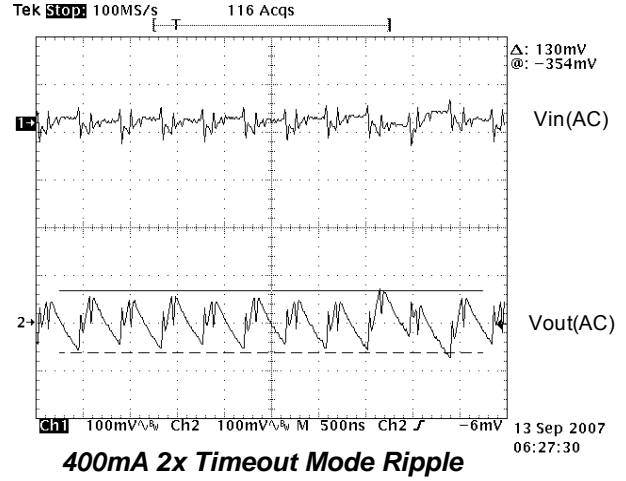
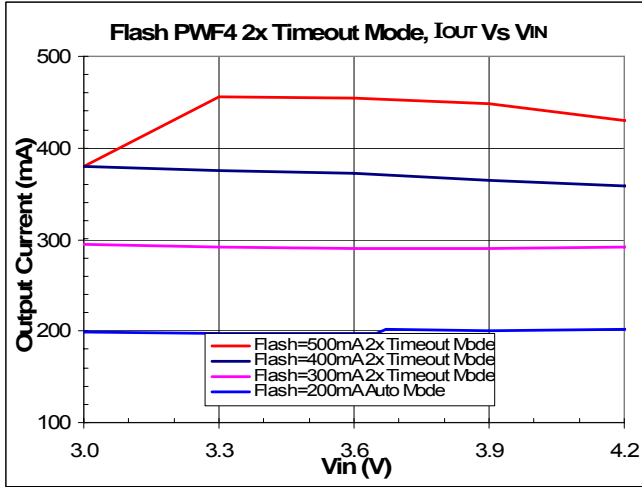

TYPICAL PERFORMANCE CHARACTERISTICS

$V_{IN} = 3.6V$, Typical Application Circuit, $T_A = 25^\circ C$ unless otherwise noted.

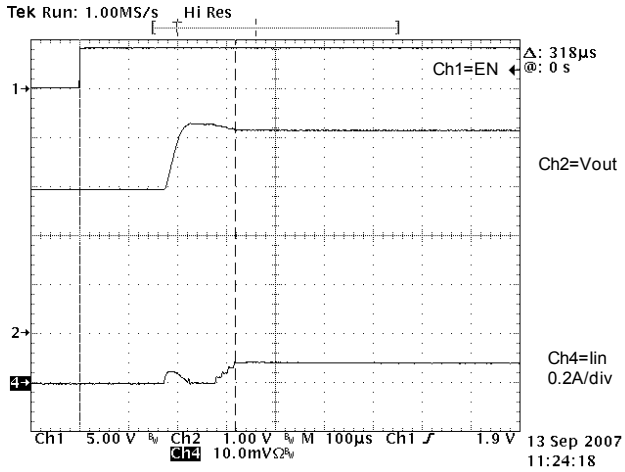

LEDs = 20mA 1x Startup from Shutdown

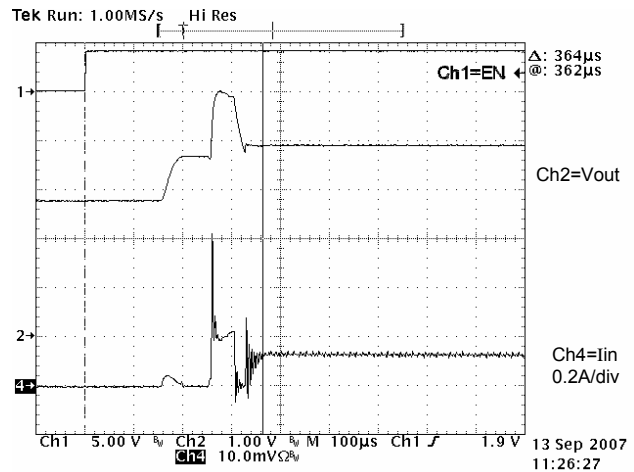

LEDs = 20mA 1.5x Startup from Shutdown

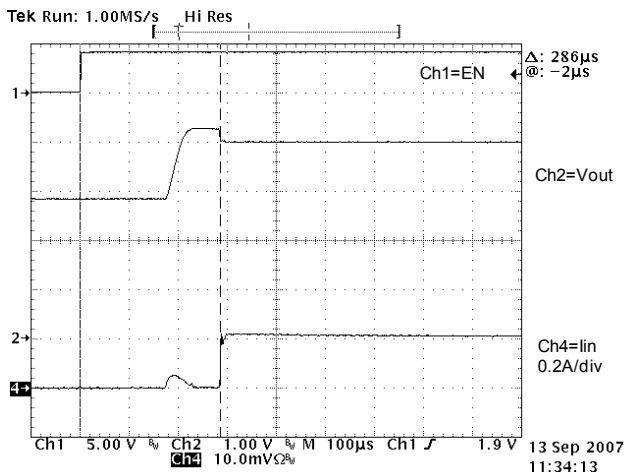

Flash = 200mA 1x Startup from Shutdown

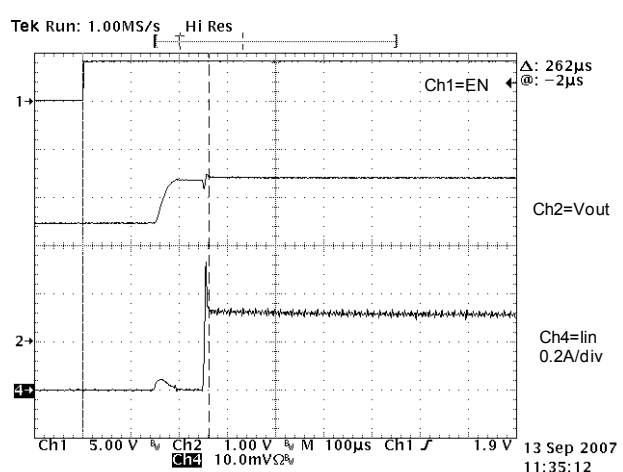

Flash = 200mA 1.5x Startup from Shutdown

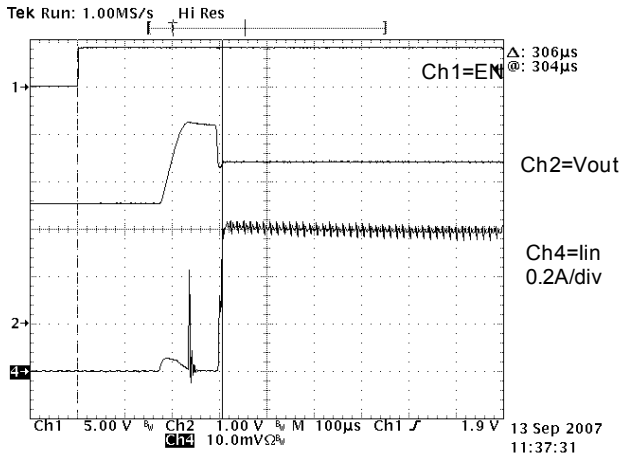

Flash = 300mA 2x Timeout Startup from SHDN

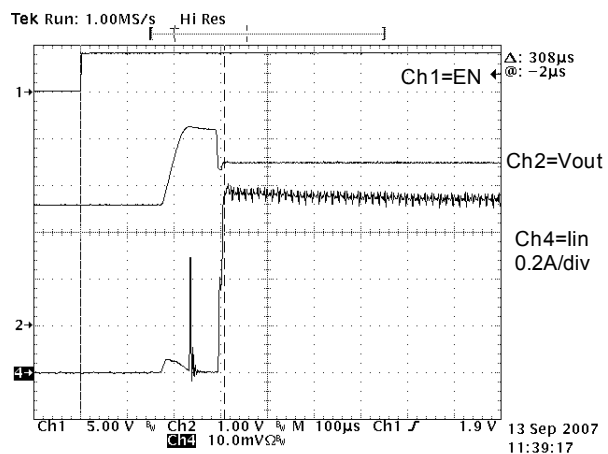

Flash = 400mA 2x Timeout Startup from SHDN

TYPICAL PERFORMANCE CHARACTERISTICS

V_{IN} = 3.6V, Typical Application Circuit, T_A = 25°C unless otherwise noted.

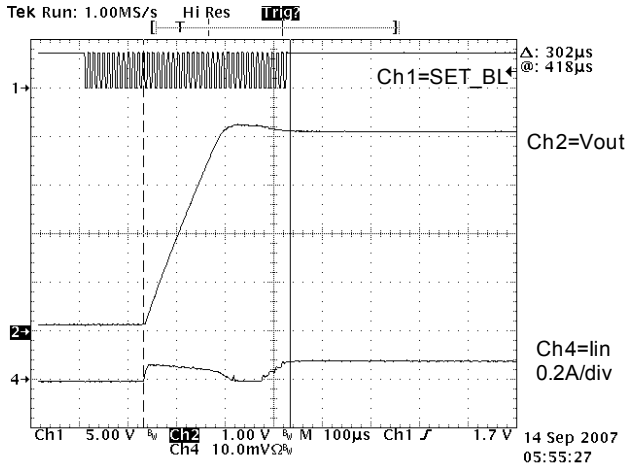

SP7682A SET_BL=41 Pulses LEDs=20mA 1x

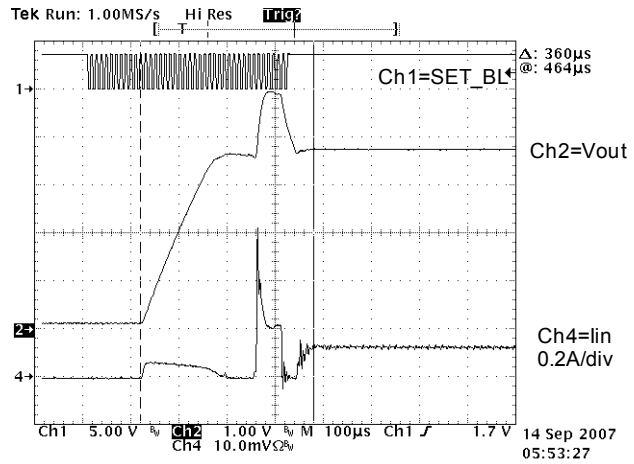

SP7682A SET_BL=41 Pulses LEDs=20mA, 1.5x

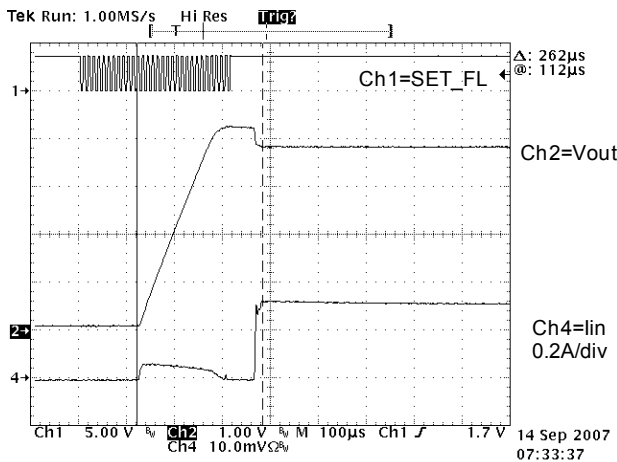

SP7682A SET_FL=31 Pulses Flash=0.3A 1x

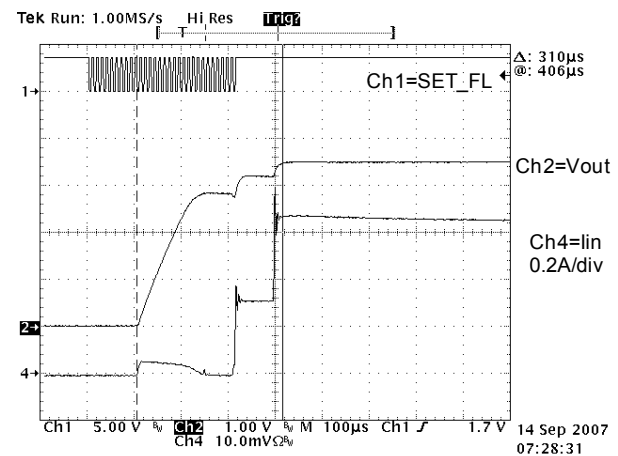

SP7682A SET_FL=31 Pulses Flash = 0.3A 2x

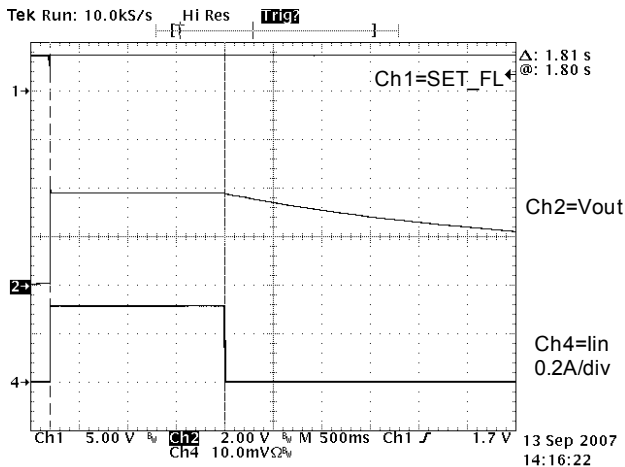

SP7682A SET_FL=31 Pulses Flash=0.3A 2s

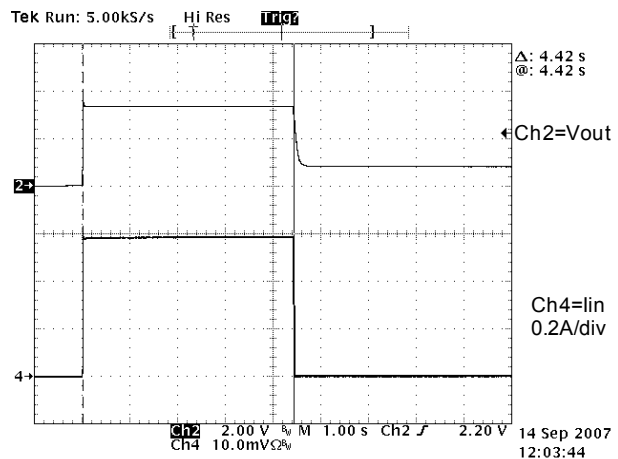

SP7682 TD0=TD1=0V Flash=0.3A 4s

TYPICAL PERFORMANCE CHARACTERISTICS

V_{IN} = 3.6V, Typical Application Circuit, T_A = 25°C unless otherwise noted.

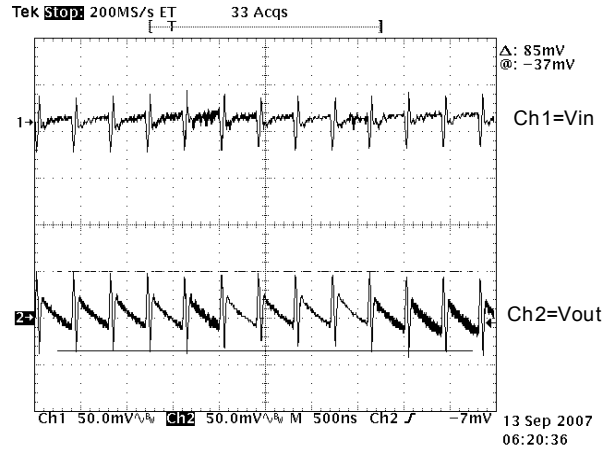
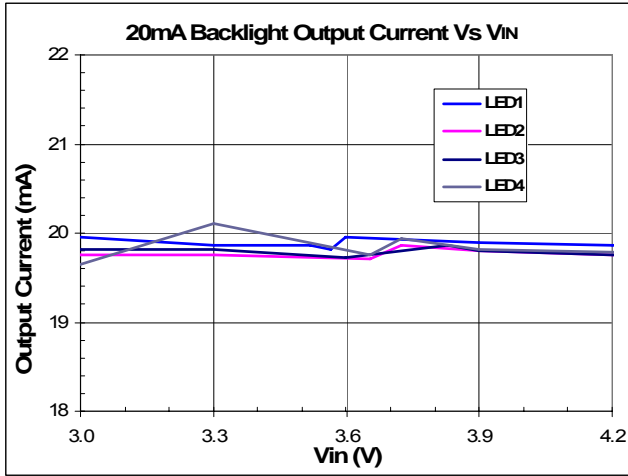

20mA Backlight: 1.5x Mode Ripple

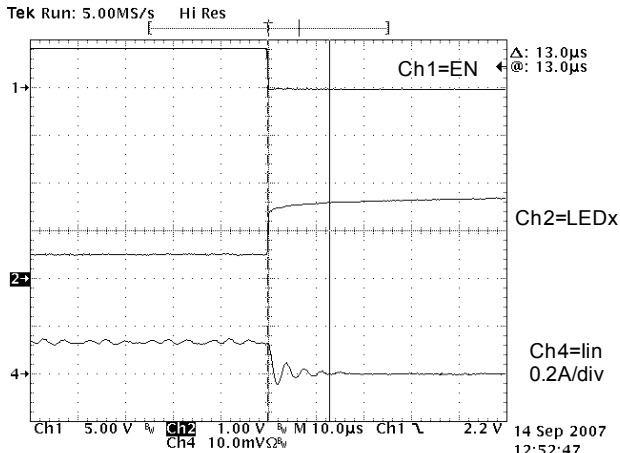

Turn-off time into SHDN LEDs=20mA

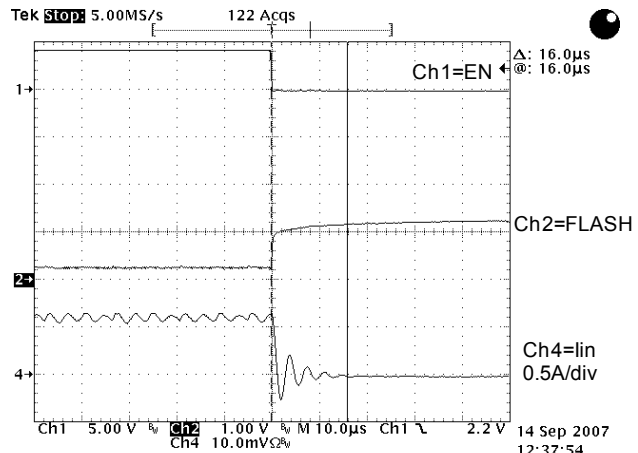

Turn-off time into SHDN Flash=0.3A

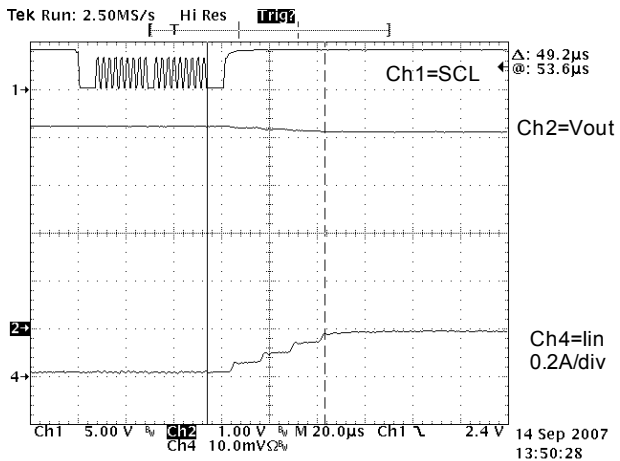

Settle last count Standby LEDs=20mA 1x

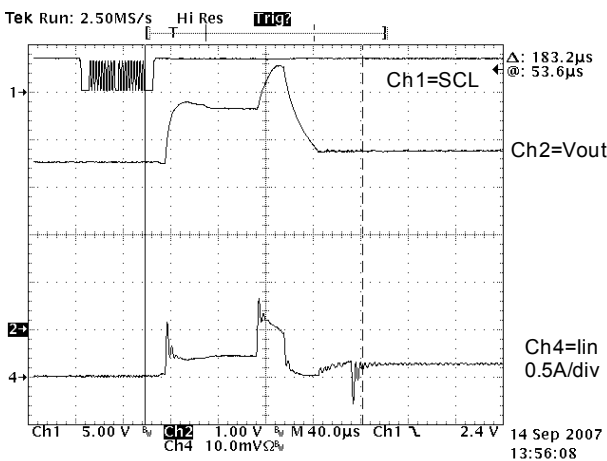

Settle last count Standby LEDs=20mA 1.5x

I²C Specifications

The I²C protocol defines any device that sends data to the bus as a transmitter and any device that reads the data as a receiver. The device that controls the data transfer is known as the master and the other

device as the slave. The master will always initiate a data transfer and will provide the serial clock for synchronization.

Data input format:

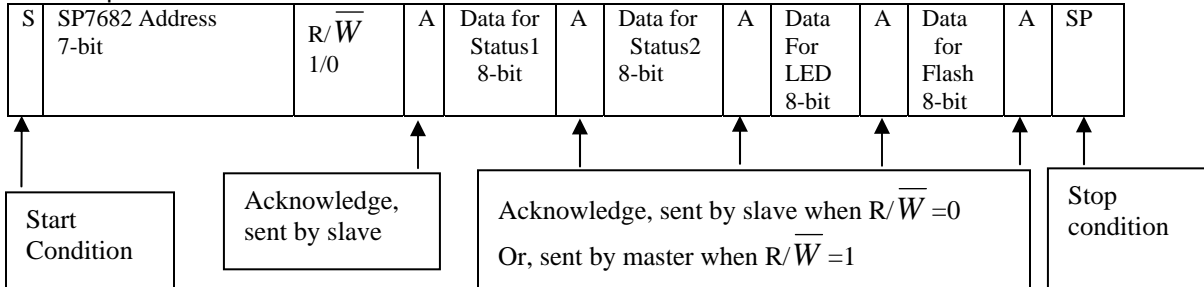

SP7682 I²C Slave Address Map: (7-bit Default Address: 0x28)

Fuses		Device Address							R/W 1/0	7-bit address Hex
Fuse1	Fuse0	A7	A6	A5	A4	A3	A2	A1	A0	A7-A1
0	0	0	1	0	1	0	0	0	0	0x28
0	1	0	1	0	0	0	0	0	0	0x20
1	0	0	1	1	1	0	0	0	0	0x38
1	1	0	1	1	0	0	0	0	0	0x30

Theory of Operation - I²C Serial Interface

The SP7682 has four data registers which can be programmed serially via the I²C interface. The first register is a status register which has two bits used for shutdown/power up options, 4 bits used for individual backlight LED ON/OFF control, and 2 bits for charge pump mode. The second STATUS register contains settings of the FLASH time-out,

Temperature OK, Voltage OK, and Flash time-out expired conditions. After the Flash timeout has expired the FTO bit will toggle on and then off for intervals set by the TDO bits. The next two registers are used to set the brightness levels of the backlight LEDs and Flash LED.

The register bits are as follows:

REGISTER	B7	B6	B5	B4	B3	B2	B1	B0
STATUS1	WZ	WP	PMP0	PMP1	LED0	LED1	LED2	LED3
STATUS2	TOUT0	TOUT1	TD0	TD1	TOK	VOK	FTO	dc
LEDS	D5	D4	D3	D2	D1	D0	dc	dc
FLASH	D5	D4	D3	D2	D1	D0	dc	dc

The following table defines the states for bits PMP0 and PMP1. These bits can be used to set the operating mode for the internal charge pump.

<u>PMP0</u>	<u>PMP1</u>	<u>State</u>
0	0	Automatic mode detection.
0	1	1x mode only. 1.5x and 2x modes are prohibited
1	0	1.5x mode only. 1x and 2x modes are prohibited.
1	1	1x or 1.5x mode auto detection. 2x mode is prohibited.

The following table defines the states for bits LED0 to LED3. These bits can be used to turn LEDs On or OFF.

<u>LED0</u>	<u>LED1</u>	<u>LED2</u>	<u>LED3</u>	<u>State</u>
1	0	0	0	LED0 OFF, other LEDs ON.
0	1	0	0	LED1 OFF, other LEDs ON.
0	0	1	0	LED2 OFF, other LEDs ON.
0	0	0	1	LED3 OFF, other LEDs ON.

The following table defines the states for bits WZ and WP. These bits can be used to put the SP7682 into shutdown, standby or active.

<u>WZ</u>	<u>WP</u>	<u>State</u>
0	0	Shutdown, data registers are reset to 000000
0	1	Shutdown, data registers are unchanged
1	0	Standby. Output current is zero, data registers are unchanged.
1	1	Active. Output current corresponds to the register contents

The following table defines the states for bits TOUT0 and TOUT1. These bits can be used to adjust current threshold for the time-out feature in Flash mode.

<u>TOUT0</u>	<u>TOUT1</u>	<u>State</u>
0	0	Time-out disabled
0	1	Timeout enabled for 110mA and above
1	0	Timeout enabled for 160mA and above
1	1	Timeout enabled for 230mA and above

The following table defines the states for bits TD0 and TD1. These bits can be used to adjust time-out delay for the time-out feature in Flash mode.

<u>TD0</u>	<u>TD1</u>	<u>State</u>
0	0	4s
0	1	2s
1	0	1s
1	1	0.5s

Addressing and Writing Data to the SP7682

To write data to the SP7682 one of the following two cycles must be obeyed:

Easy shutdown/startup sequence

[Slave Address with write bit][Data for Status]

Full shutdown/startup sequence

[Slave Address with write bit][Data for Status1][Data for Status2][Data for LEDs][Data for FLASH]

Addressing and Reading Data from the SP7682

To read data from the SP7682 the following data cycle must be obeyed:

[Slave Address with read bit][Data for Status1][Data for Status2][Data for LEDs][Data for FLASH]

DAC table for Backlight LED intensity

In the LED register bits B7, B6, B5, B4, B3 and B2 represent the DAC codes D5-D0 used to set the LED current in the four LEDs. The following table lists the DAC codes and the corresponding current for each channel in mA:

B7-B2	BL (mA)	B7-B2	BL (mA)
000000	0	100000	16.0
000001	0.5	100001	16.5
000010	1.0	100010	17.0
000011	1.5	100011	17.5
000100	2.0	100100	18.0
000101	2.5	100101	18.5
000110	3.0	100110	19.0
000111	3.5	100111	19.5
001000	4.0	101000	20.0
001001	4.5	101001	20.5
001010	5.0	101010	21.0
001011	5.5	101011	21.5
001100	6.0	101100	22.0
001101	6.5	101101	22.5
001110	7.0	101110	23.0
001111	7.5	101111	23.5
010000	8.0	110000	24.0
010001	8.5	110001	24.5
010010	9.0	110010	25.0
010011	9.5	110011	25.5
010100	10.0	110100	26.0
010101	10.5	110101	26.5
010110	11.0	110110	27.0
010111	11.5	110111	27.5
011000	12.0	111000	28.0
011001	12.5	111001	28.5
011010	13.0	111010	29.0
011011	13.5	111011	29.5
011100	14.0	111100	30.0
011101	14.5	111101	30.5
011110	15.0	111110	31.0
011111	15.5	111111	31.5

DAC table for FLASH LED intensity

In the FLASH register bits B7, B6, B5, B4, B3 and B2 represent the DAC codes D5-D0 used to set the LED current in the four LEDs. The following table lists the DAC codes and the corresponding current for each channel in mA:

B7-B2	Flash (mA)	B7-B2	Flash (mA)
000000	0	100000	320
000001	10	100001	330
000010	20	100010	340
000011	30	100011	350
000100	40	100100	360
000101	50	100101	370
000110	60	100110	380
000111	70	100111	390
001000	80	101000	400
001001	90	101001	410
001010	100	101010	420
001011	110	101011	430
001100	120	101100	440
001101	130	101101	450
001110	140	101110	460
001111	150	101111	470
010000	160	110000	480
010001	170	110001	490
010010	180	110010	500
010011	190	110011	500
010100	200	110100	500
010101	210	110101	500
010110	220	110110	500
010111	230	110111	500
011000	240	111000	500
011001	250	111001	500
011010	260	111010	500
011011	270	111011	500
011100	280	111100	500
011101	290	111101	500
011110	300	111110	500
011111	310	111111	500

SP7682A Single Line Programmable Serial Interface

SET_FL (or SET_BL) pin programming waveform shown below:

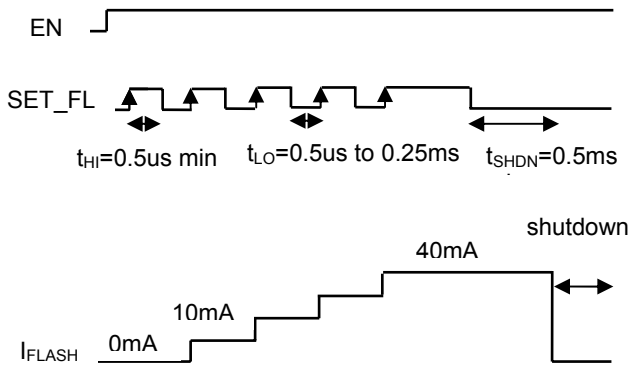

In the above example code 5 is programmed as there are five rising edges.

Serially Programmable Codes

Flash Code Table (programmed via SETFL)

code	Flash (mA)	code	Flash (mA)	code	Flash (mA)
1	0	18	170	35	340
2	10	19	180	36	350
3	20	20	190	37	360
4	30	21	200	38	370
5	40	22	210	39	380
6	50	23	220	40	390
7	60	24	230	41	400
8	70	25	240	42	410
9	80	26	250	43	420
10	90	27	260	44	430
11	100	28	270	45	440
12	110	29	280	46	450
13	120	30	290	47	460
14	130	31	300	48	470
15	140	32	310	49	480
16	150	33	320	50	490
17	160	34	330	51	500

Backlight Code Table (programmed via SETBL)

code	BL (mA)	code	BL (mA)	code	BL (mA)
1	0	22	10.5	43	21
2	0.5	23	11	44	21.5
3	1	24	11.5	45	22
4	1.5	25	12	46	22.5
5	2	26	12.5	47	23
6	2.5	27	13	48	23.5
7	3	28	13.5	49	24
8	3.5	29	14	50	24.5
9	4	30	14.5	51	25
10	4.5	31	15	52	25.5
11	5	32	15.5	53	26
12	5.5	33	16	54	26.5
13	6	34	16.5	55	27
14	6.5	35	17	56	27.5
15	7	36	17.5	57	28
16	7.5	37	18	58	28.5
17	8	38	18.5	59	29
18	8.5	39	19	60	29.5
19	9	40	19.5	61	30
20	9.5	41	20	62	30.5
21	10	42	20.5	63	31
				64	31.5

LED Selection

The SP7682 is designed as a driver for backlight white LEDs and Flash white LEDs, but is capable of driving other LED types with forward voltage specifications ranging from 2.0V to 3.8V. LED applications may include LCD display backlighting, camera photo-flash applications, infrared (IR) diodes for remotes, and other loads benefiting from a controlled output current generated from a varying input voltage. Since the D1 to D4 output current-sinks are matched with negligible voltage dependence, the LED brightness will be matched regardless of the specific LED forward voltage (V_F) levels. In flash applications, it may be necessary to drive high- V_F type LEDs. The typical characteristic curves illustrate low V_F Flash LEDs using the Lumi-LEDs PWF4 LED, but the low dropout current-sinks in the SP7682 make it capable of driving LEDs with forward voltages as high as 4.0V from an input supply as low as 3.2V but at a reduced output current.

Device Switching Noise Performance

The SP7682 operates at a fixed frequency of approximately 2.4MHz to control noise and limit harmonics that can interfere with the RF operation of cellular telephone handsets or other communication devices. Back-injected noise appearing on the input pin of the charge pump can be much less than 100mV peak-to-peak, typically less than inductor-based DC/DC boost converter white LED backlight solutions. The SP7682 soft-start feature helps prevent noise transient effects associated with inrush currents during startup of the charge pump circuit.

Power Efficiency

The charge pump efficiency shown in the typical characteristic curves is shown for two cases. The first case is called output efficiency which is the power efficiency to the output as a ratio of the output voltage power to the input voltage power and expressed as a percentage. The second case is called LED efficiency and is the power efficiency to the LED outputs and is expressed as a ratio of the power to the LEDs to the input voltage power. These expressions are shown at the end of this section in their formulas. The first case is what is generally shown in competitors' datasheets and is shown

here for reference. The second case of LED power efficiency is included to show the user the true power delivered to the LEDs. As one can see in the curves, the LED efficiency is greatest when V_{IN} is higher than the V_F of the LEDs (and higher than the voltage required on the constant current-sink outputs of the LEDs) and that is when the SP7682 is in the 1x mode. When V_{IN} is less than the V_F (and less than the voltage required on the constant current-sink outputs of the LEDs) the SP7682 is in the 1.5x mode or 2x mode and in these modes the input current is 1.5 times or 2 times the output current and therefore the efficiency will be reduced.

$$V_{OUT} \text{ efficiency} = \frac{V_{OUT} \cdot I_{OUT}}{(V_{IN} \cdot I_{IN})} \cdot 100\%$$

$$\text{LED efficiency} = \frac{(V_{OUT} - V_{LED}) \cdot I_{OUT}}{(V_{IN} \cdot I_{IN})} \cdot 100\%$$

Refer to the Typical Characteristics section of this document for measured plots of efficiency versus input voltage and output load current versus input voltage for given LED output current options.

Capacitor Characteristics

Ceramic composition capacitors are highly recommended over all other types of capacitors for use with the SP7682. Ceramic capacitors offer many advantages over their tantalum and aluminum electrolytic counterparts. A ceramic capacitor has very low ESR, is lower in cost, has a smaller PCB footprint, and is non-polarized. Low ESR ceramic capacitors help to maximize charge pump transient response. Since ceramic capacitors are non-polarized, they are not prone to incorrect connection damage.

Equivalent Series Resistance (ESR)

ESR is an important characteristic to consider when selecting a capacitor. ESR is a resistance internal to a capacitor that is caused by the leads, internal connections, size or area, material composition, and ambient temperature. Capacitor ESR is typically measured in milliohms for ceramic capacitors and can range to more than several Ohms for tantalum or aluminum electrolytic capacitors.

Ceramic Capacitor Materials

Capacitors with large output values are typically composed of X7R, X5R, Z5U, or Y5V dielectric materials, but Z5U and Y5V are not recommended since they have a large change in value with temperature. X5R and X7R capacitors are recommended since they are relatively low in cost and their output value changes with temperature are relatively small.

Capacitor Selection

Careful selection of the four external capacitors C_{IN}, C₁, C₂, and C_{OUT} is important because they will affect turn-on time, output ripple, and transient performance. Optimum performance will be obtained when low equivalent series resistance (ESR) ceramic capacitors are used. In general, low ESR may be defined as less than 100mΩ. A value of 4.7μF for the input and 2.2μF for the output capacitor is sufficient for most applications. The flying capacitors C₁ and C₂

can be 1μF for most applications for backlight and Flash, and for light output currents flying capacitors of 0.47uF can be used. For applications when the 4 backlight LED drivers are drive 20mA or more and the Flash driver is driven to 100mA or more, it is advisable to use a 4.7μF input capacitor in order to reduce the input ripple as seen by the battery. If the LED current-sinks are only programmed for low current levels, or if the application is not very noise sensitive, then a 2.2μF input capacitor may be used. See table 1 for capacitor selection.

Thermal Protection

The SP7682 has a thermal protection circuit that will shut down the internal LDO and charge pump if the die temperature rises above the thermal limit, and will restart when the die temperature drops about 20°C below the thermal limit.

Table 1: SP7682/SP7682A Capacitor Selection

Manufacturers/ Website	Part Number	Capacitance/ Voltage	Capacitor Size/Type/Thickness	ESR at 100kHz
TDK/www.tdk.com	C1005X5R0J474K	0.47uF/6.3V	0402/X5R/0.55mm	0.05
TDK/www.tdk.com	C1005X5R0J105K	1uF/6.3V	0402/X5R/0.55mm	0.03
TDK/www.tdk.com	C1608X5R0J225K	2.2uF/6.3V	0603/X5R/0.9mm	0.03
TDK/www.tdk.com	C1608X5R0J475K	4.7uF/6.3V	0603/X5R/0.9mm	0.02
Murata/www.murata.com	GRM155R60J474KE19	0.47uF/6.3V	0402/X5R/0.55mm	0.05
Murata/www.murata.com	GRM155R60J105KE19	1uF/6.3V	0402/X5R/0.55mm	0.03
Murata/www.murata.com	GRM185R60J225KE26	2.2uF/6.3V	0603/X5R/0.55mm	0.03
Murata/www.murata.com	GRM188R60J475KE19	4.7uF/6.3V	0603/X5R/0.8mm	0.02

FOOTPRINT: 3x3mm 16 pin QFN

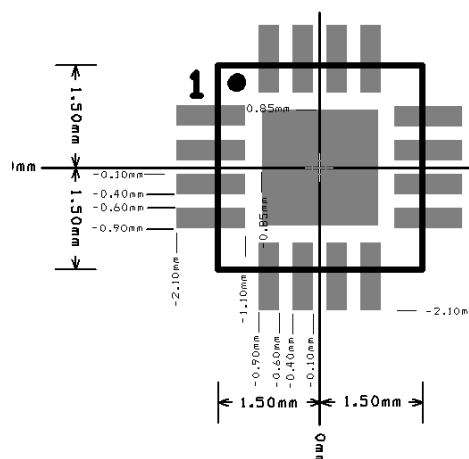

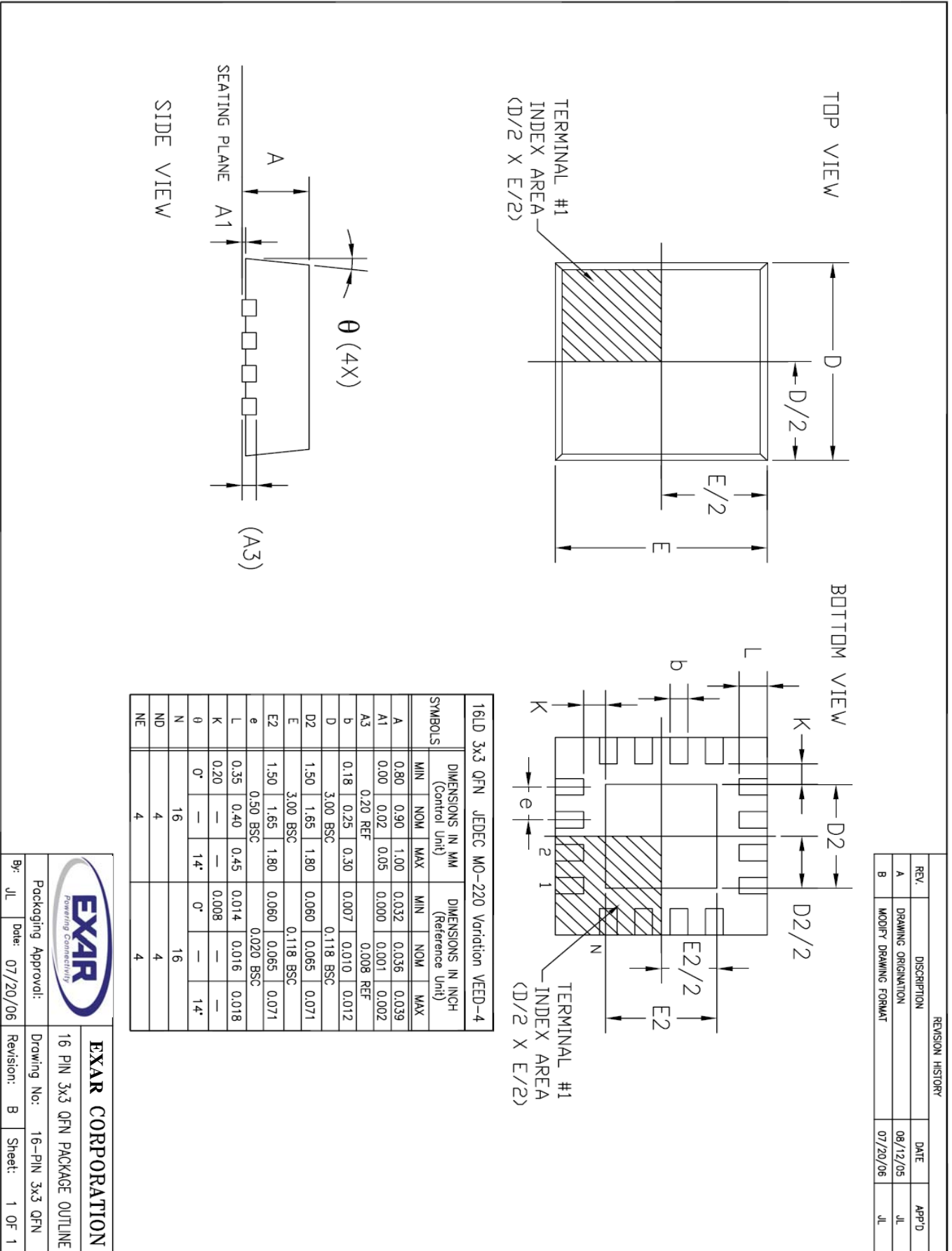



ORDERING INFORMATION

Part Number	Control Interface	Min Temp °C	Max Temp °C	RoHS	Theta JA °C/W	MSL Level	Pack Type	Quantity	Package
SP7682ER1-L	I ² C	-40	85	Yes	33.3	L3 @ 260°C	Canister	Any	3x3 16 Pin QFN
SP7682ER1-L/TR	I ² C	-40	85	Yes	33.3	L3 @ 260°C	Tape & Reel	3000	3x3 16 Pin QFN
SP7682EB	I ² C	-40	85	Not Applicable to Eval Board					Board
SP7682AER1-L	Single Wire	-40	85	Yes	33.3	L3 @ 260°C	Canister	Any	3x3 16 Pin QFN
SP7682AER1-L/TR	Single Wire	-40	85	Yes	33.3	L3 @ 260°C	Tape & Reel	3000	3x3 16 Pin QFN
SP7682AEB	Single Wire	-40	85	Not Applicable to Eval Board					Board

For further assistance:

Email: Sipexsupport@sipex.com
WWW Support page: <http://www.sipex.com/content.aspx?p=support>
Application Notes: <http://www.sipex.com/applicationNotes.aspx>

EXAR Corporation reserves the right to make changes to the products contained in this publication in order to improve design, performance or reliability. EXAR Corporation assumes no responsibility for the use of any circuits described herein, conveys no license under any patent or other right, and makes no representation that the circuits are free of patent infringement. Charts and schedules contained here in are only for illustration purposes and may vary depending upon a user's specific application. While the information in this publication has been carefully checked; no responsibility, however, is assumed for inaccuracies.

EXAR Corporation does not recommend the use of any of its products in life support applications where the failure or malfunction of the product can reasonably be expected to cause failure of the life support system or to significantly affect its safety or effectiveness. Products are not authorized for use in such applications unless EXAR Corporation receives, in writing, assurances to its satisfaction that: (a) the risk of injury or damage has been minimized; (b) the user assumes all such risks; (c) potential liability of EXAR Corporation is adequately protected under the circumstances.