

## 2 or 3 Channel Low Dropout High Side Linear LED Driver

### FEATURES

- LED Driver for common cathode parallel connected LEDs
- Ultra Low Dropout Voltage of 150mV
- No EMI, no switching noise
- Integrated current matching
- PWM and Analog brightness control
- Enable/Shutdown control
- Shutdown current <math>< 1\mu\text{A}</math>
- Lead Free, RoHS Compliant Package: Small footprint SOT23-6

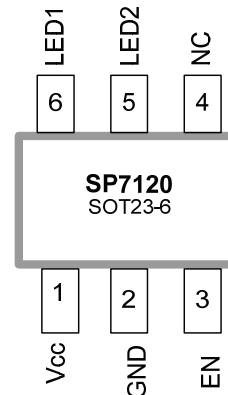

### APPLICATIONS

- Mobile Phones
- PDA, DSC, MP3 players
- Handheld Computers
- Keypads and display backlight

### GENERAL DESCRIPTION

The SP712X driver's family provides a simple solution for a matched current source for any color common cathode LED configuration. The common cathode connection allows the user to increase the LED power dissipation by having the cathodes heat-sinked to the ground plane of the circuit board. The SP7120 may drive two LEDs or one LED at twice the current with two channels connected in parallel. The SP7122 can drive three LEDs or one LED at three times the current. The factory preset current values are 15mA (version A), 20mA (version B), or 25mA (version C) per channel. In shutdown mode (EN pin is LOW), the supply current drops to 40nA typical. The SP712x drivers are available in a small footprint 6-pin SOT23-6 package.

### APPLICATION SCHEMATIC

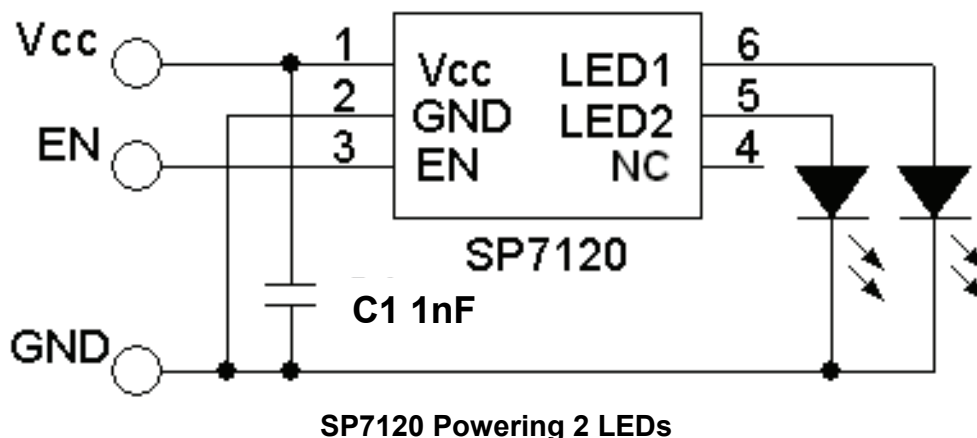

## ABSOLUTE MAXIMUM RATINGS

These are stress ratings only and functional operation of the device at these ratings or any other above those indicated in the operation sections of the specifications below is not implied. Exposure to absolute maximum rating conditions for extended period may affect reliability.

V<sub>CC</sub>, V<sub>LED1</sub>, V<sub>LED2</sub>, and EN to GND -0.3V to 6V  
 Junction Temperature.....+150°C  
 Operating Temperature.....-40 to +85°C  
 Storage Temperature.....-65°C to +150°C  
 Package Thermal resistance  $\theta_{JA}$  ..... 190°C/W  
 ESD Level.....2kV HBM  
 ESD Level.....200V MM  
 ESD Level EN.....1.5kV HBM  
 Lead Temperature (Soldering, 10 sec) ...300°C

### RECOMMENDED OPERATING CONDITIONS

Ambient operating temperature ..... -40 to+85°C

## ELECTRICAL CHARACTERISTICS

Specifications are at T<sub>A</sub>=25°C, V<sub>CC</sub> = 2.7 to 5.5, ENABLE =V<sub>CC</sub>

Parameter	Min	Typ	Max	Units	Conditions	
V <sub>CC</sub>	2.7		5.5	V		
Shutdown Current		0.04	1	μA	EN = LOW	
VLED Dropout Voltage, V <sub>d</sub> <sup>1</sup>		160	200	mV	V <sub>CC</sub> = 5.5V, I <sub>LED</sub> = 20mA	
VLED Dropout voltage, V <sub>d</sub> <sup>1</sup>		140	180	mV	V <sub>CC</sub> = 5.5V, I <sub>LED</sub> = 15mA	
LED Current Accuracy <sup>2</sup>	Version A	14	15	16	mA	300mV<V <sub>D</sub> <1.0V
	Version B	19	20	21		300mV<V <sub>D</sub> <1.0V
	Version C	24	25	26		300mV<V <sub>D</sub> <1.0V
Quiescent Current	Version A		0.5	0.7	mA	SP7120 at V <sub>D</sub> = 300mV
	Version B		0.7	1.1		
	Version C		0.86	1.7		
	Version A		0.6	0.8	mA	SP7122 at V <sub>D</sub> = 300mV
	Version B		0.9	1.2		
	Version C		0.99	1.9		
LED to LED Current Matching <sup>6</sup>		0.8		%	V <sub>CC</sub> = 5.5V, V <sub>D</sub> > 300mV	
LED Current Line Regulation <sup>3</sup>			.25	%/V	2.7V < V <sub>CC</sub> < 5.5V	
LED Current Load Regulation <sup>4</sup>			1.0	%/mA	300mV < V <sub>D</sub> < 1.0V	
LED Current Thermal Regulation		0.01		%/°C	V <sub>D</sub> = 300mV	
EN ON Voltage (HIGH) <sup>5</sup>	2		V <sub>CC</sub>	V		
EN OFF Voltage (LOW)	0		0.8	V		
EN Input Bias Current	2	3	5	μA	V <sub>EN</sub> = V <sub>CC</sub> = 5.5V	
EN Switching Frequency			20	kHz		
EN ON Minimum Pulse Width			15	μs		

- 1) Difference between V<sub>CC</sub> voltage and LED anode voltage at which I<sub>LED</sub> current drops 10% from nominal value
- 2) I<sub>LED</sub> Current Variations from specified value
- 3) I<sub>LED</sub> Current Variations per volt V<sub>CC</sub> change for any given temperature
- 4) I<sub>LED</sub> Current Variations at V<sub>D</sub> change from 0.3V to 1.0V
- 5) EN input voltage should not exceed V<sub>CC</sub> voltage at any condition
- 6) This condition is part of the LED current accuracy and it shall not exceed that specification

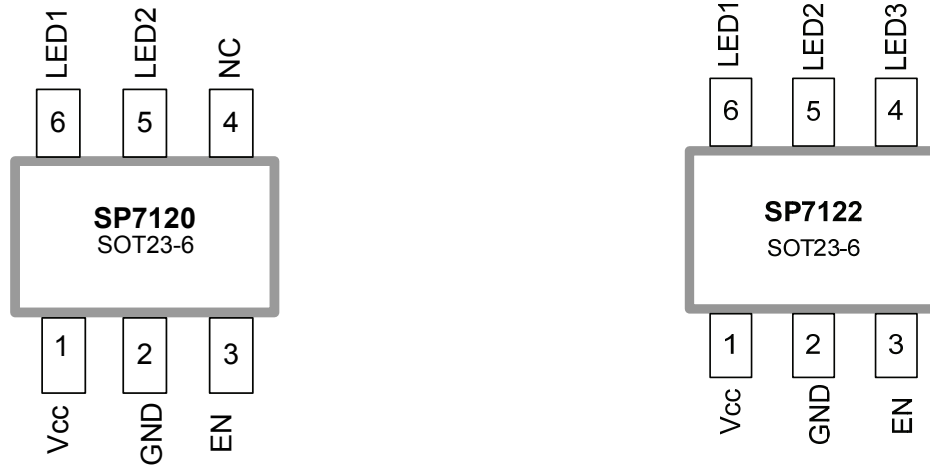

Pin Name	SP7120	SP7122	Pin Description
Vcc	1	1	Power input pin. Bypass Vcc to GND with 1nF capacitor as close to VIN as possible
GND	2	2	Ground pin
EN	3	3	Enable pin. Device is active if EN is logic HIGH
NC	4		No Connect should be left floating
LED3		4	Connect anode of LED3
LED2	5	5	Connect anode of LED2
LED1	6	6	Connect anode of LED1

BLOCK DIAGRAM

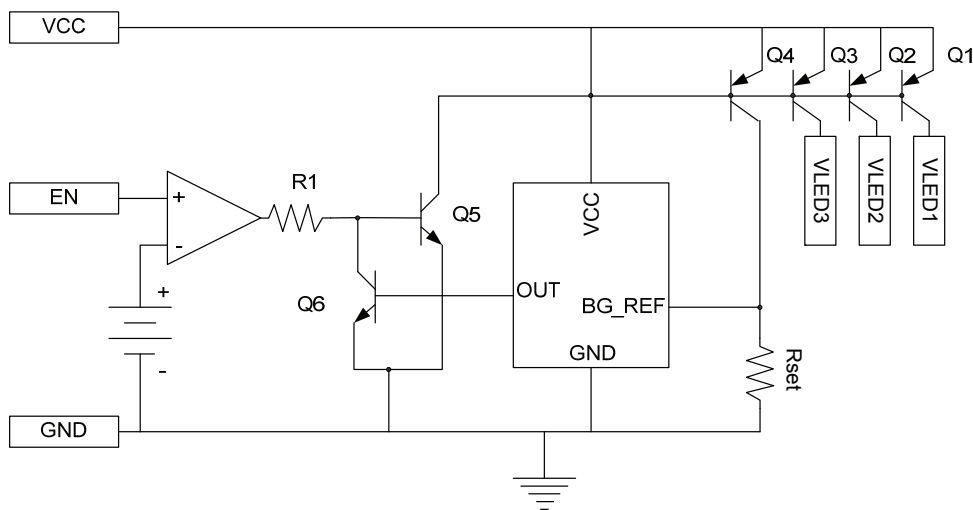

## OUTPUT CURRENT SELECTION TABLE

Part Number	Output Current per channel	Number of Channels	Comments
SP7120A	15mA	2	Channels can be combined for higher output current
SP7120B	20mA	2	Channels can be combined for higher output current
SP7120C	25mA	2	Channels can be combined for higher output current
SP7122A	15mA	3	Channels can be combined for higher output current
SP7122B	20mA	3	Channels can be combined for higher output current
SP7122C	25mA	3	Channels can be combined for higher output current

## CIRCUIT DESCRIPTION

The SP712X drivers are regulated current sources with an enable input. The SP7120 and SP7122 have factory preset LED current at three programmed levels: 15mA, 20mA or 25mA (versions A, B, and C respectively). The SP712X circuit consists of enable, bandgap reference, and current amplifier circuit blocks. Enable circuit block provides the enable and PWM function for the SP712x. The bandgap reference provides a stable voltage source from which the output current is derived.

### ENABLE

The SP712X drivers have a low current shutdown function. In shutdown mode, the part draws less than 1µA current maximum. The part can be set into shutdown mode using the EN pin (EN = LOW). The enable pin cannot be left floating. There are no predefined internal states, so leaving this pin open will cause the part to operate incorrectly.

### PWM Dimming

The SP712X drivers allow LED-dimming control by applying PWM signaling to EN pin. The acceptable frequency range of this signal is 100Hz to 20 kHz. The minimum ON time that is required for the Enable pin is 15µs. Thus for a 2kHz PWM signal, the acceptable duty cycle range is 3% to 100%. To find the minimum PWM duty cycle the following steps are needed:

Step 1: Determine the time period of the PWM frequency

$$T = \frac{1}{PWMf}$$

Where  $PWMf$  is the PWM frequency

Step 2: take the minimum enable ON time; this is 15µs for the SP712x parts

$$\%Minimum\ Duty\ Cycle = \left( \frac{15\mu S}{T} \right) \cdot 100$$

Example

For a 2kHz signal the minimum duty cycle for the PWM signal is

$$T = \frac{1}{2000Hz} = 500\mu S$$

$$\%Minimum\ Duty\ Cycle = \left( \frac{15\mu S}{500\mu S} \right) \cdot 100$$

%Minimum Duty cycle = 3%

### Fault Operation

If one of LEDs is shorted, the voltage across The Sp712X for that LED pin will be Vcc, but that channel will still provide the nominal current value thus increasing power dissipation. If all channels are shorted, excessive power dissipation may damage the device. If an LED is open, the LED pin voltage will be pulled up to Vcc, and LED

current will be reduced to 3mA for the other channels.

## APPLICATION CIRCUITS

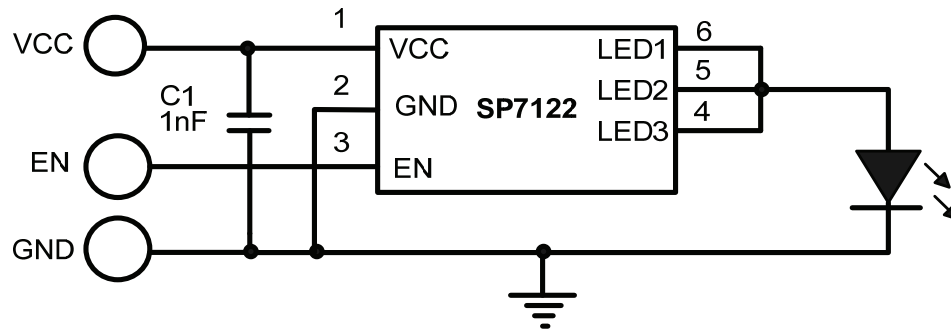

Powering 1 high power LED IOUT up to 75mA with C version

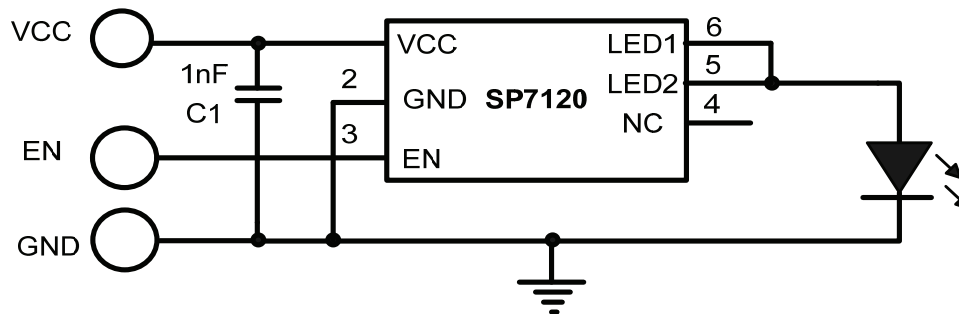

Powering 1 high power LED IOUT up to 50mA with C version

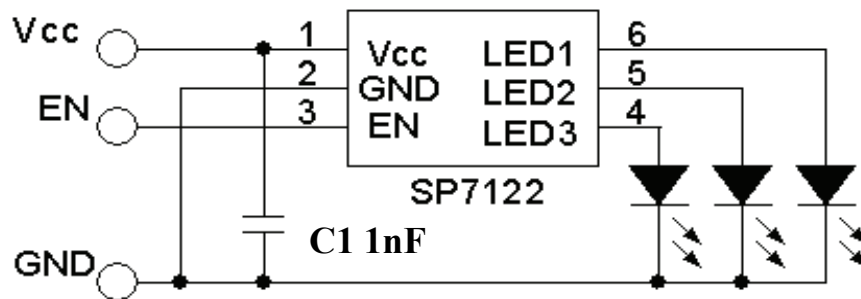

SP7122 Powering 3 LED's

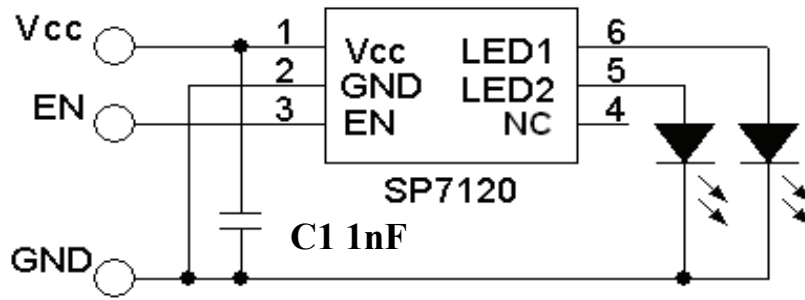

**SP7120 Powering 2 LEDs**

**BOARD LAYOUT AND GROUNDING**

To obtain the best performance from the SP712X, a printed circuit board with ground plane is required. High quality, low series resistance ceramic 1nF bypass capacitors should be used at the Vcc and GND pins. This capacitor must be located as close to the pins as possible. The traces connecting the pins and these capacitors must be kept short and should be made as wide as possible.

**TYPICAL PERFORMANCE SP7120A**

The quiescent current is part of the total output current

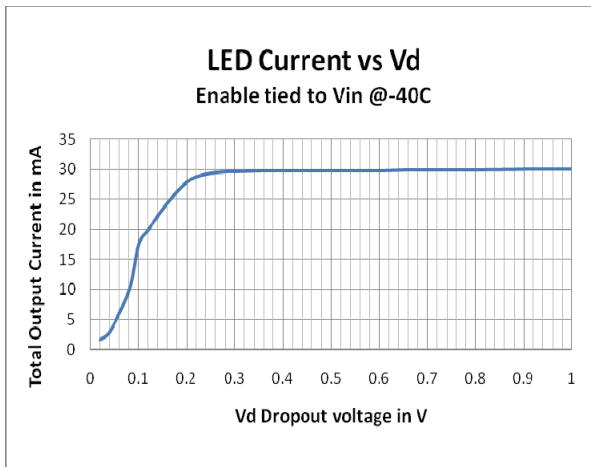

*I<sub>OUT</sub> is for 2 Channels 15mA per channel*

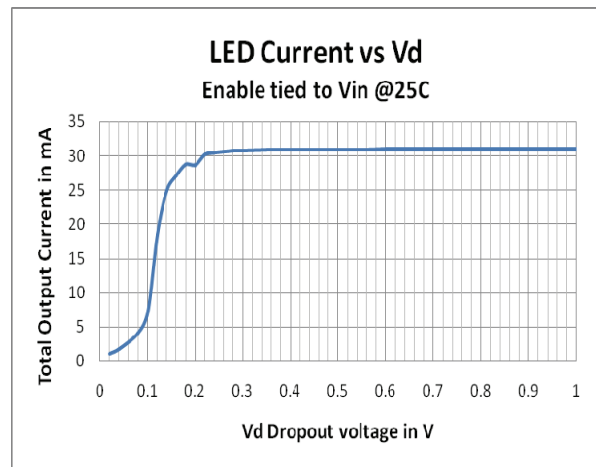

*I<sub>OUT</sub> is for 2 Channels 15mA per channel*

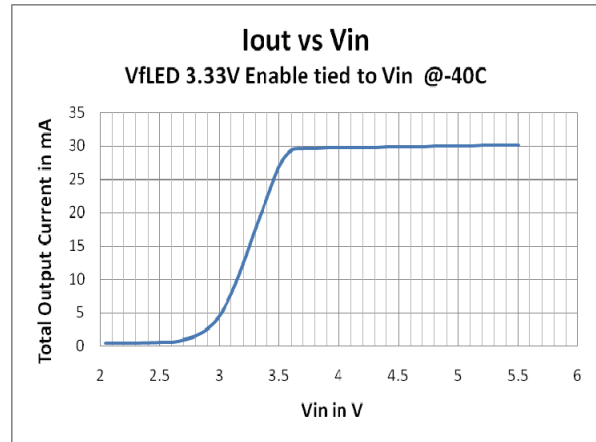
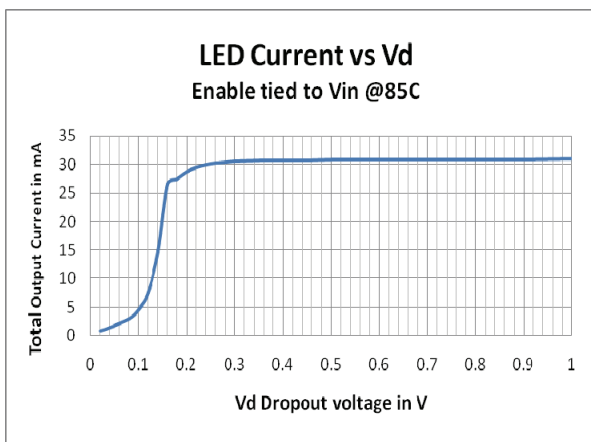

*I<sub>OUT</sub> is for 2 Channels 15mA per channel*

*I<sub>OUT</sub> is for 2 Channels 15mA per channel*

**TYPICAL PERFORMANCE SP7120A**

The quiescent current is part of the total output current

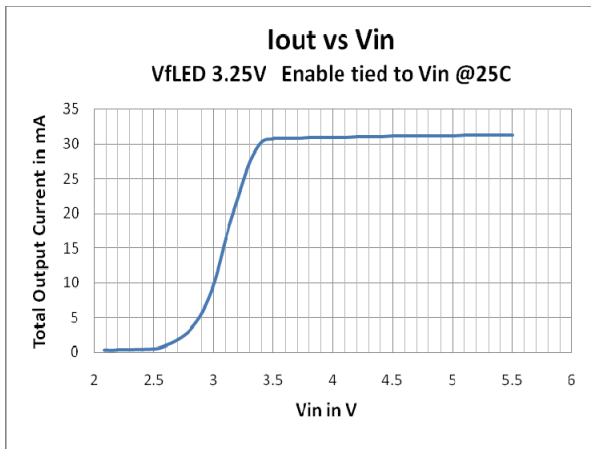

*I<sub>OUT</sub> is for 2 Channels 15mA per channel*

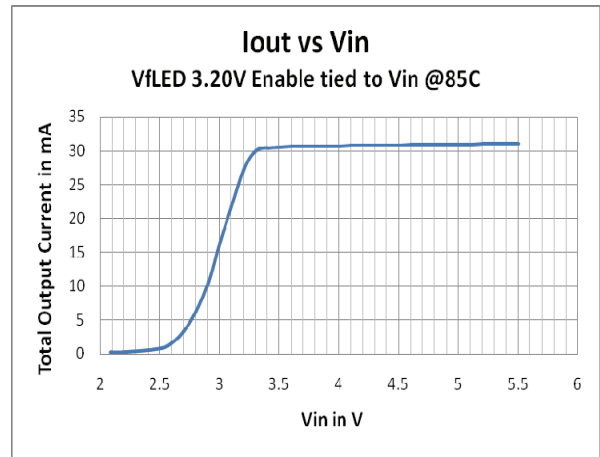

*I<sub>OUT</sub> is for 2 Channels 15mA per channel*

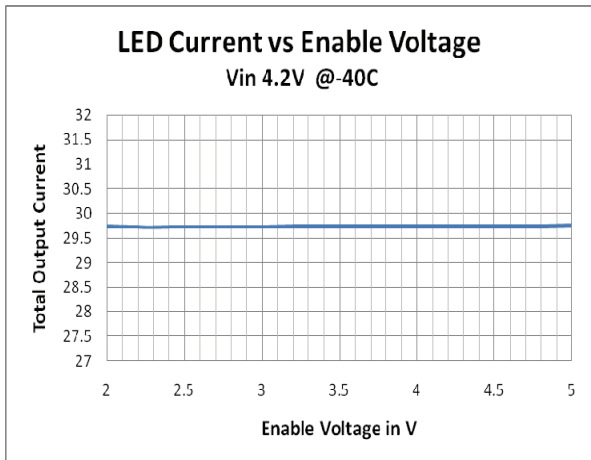

*I<sub>OUT</sub> is for 2 Channels 15mA per channel*

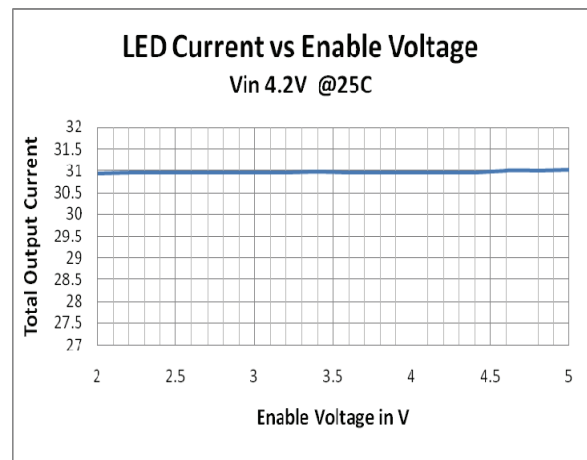

*I<sub>OUT</sub> is for 2 Channels 15mA per channel*

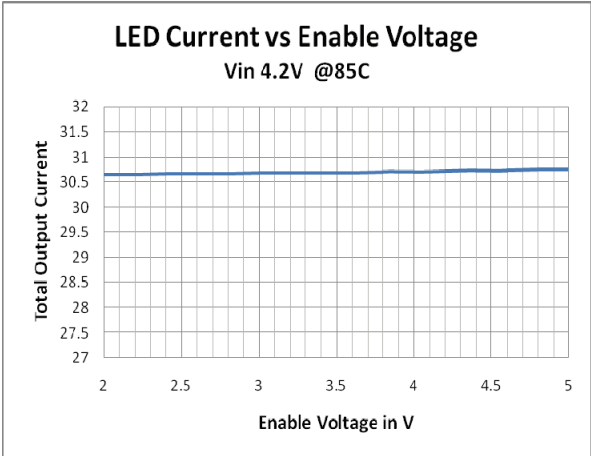

*I<sub>OUT</sub> is for 2 Channels 15mA per channel*

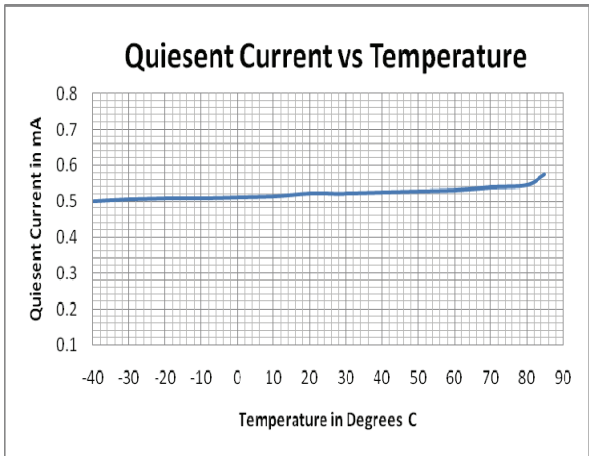

*I<sub>OUT</sub> is for 2 Channels 15mA per channel*

**TYPICAL PERFORMANCE SP7120A**

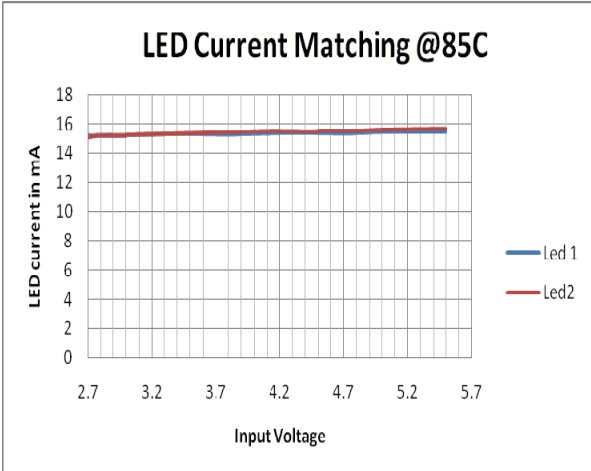
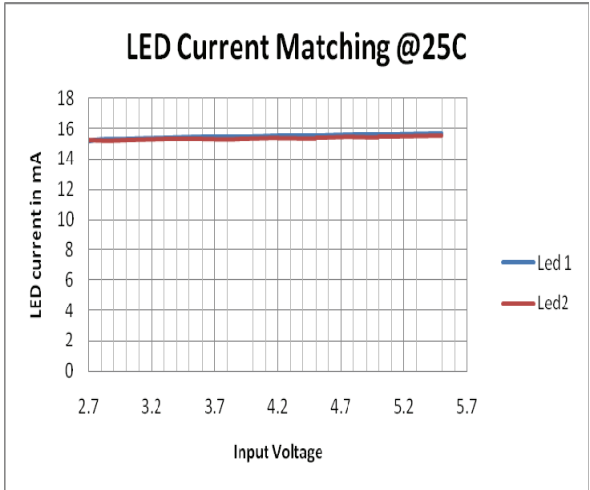
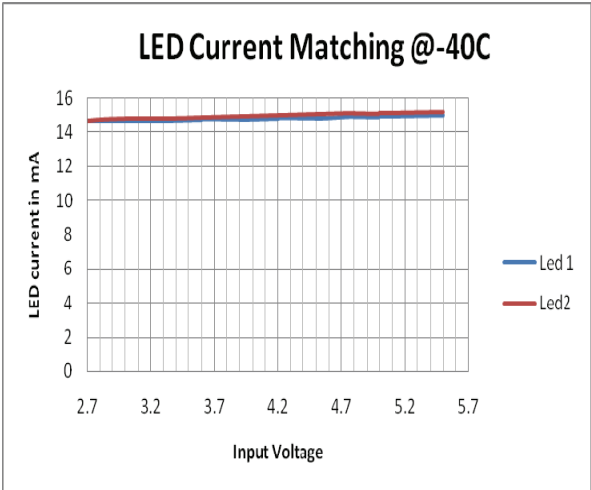



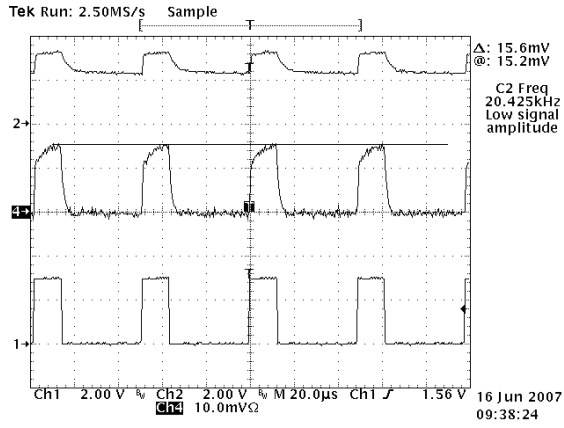

**PWM Minimum duty cycle 15µS 20kHz**

CH1: PWM Signal CH2: Anode of LED  
 CH4: LED current 10mA/div

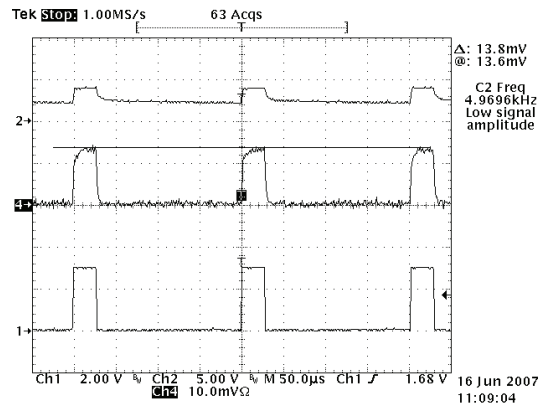

**PWM Low duty cycle 15µS 5kHz**

CH1: PWM Signal CH2: Anode of LED  
 CH4: LED current 10mA/div

**TYPICAL PERFORMANCE SP7120A**

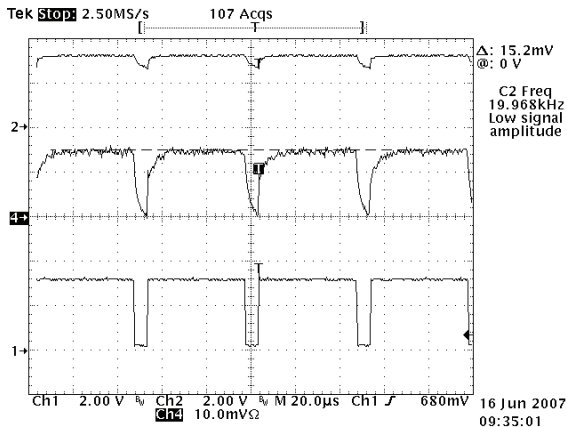

**PWM High Duty Cycle 20kHz**  
 CH1: PWM Signal CH2: Anode of LED  
 CH4: LED current 10mA/div

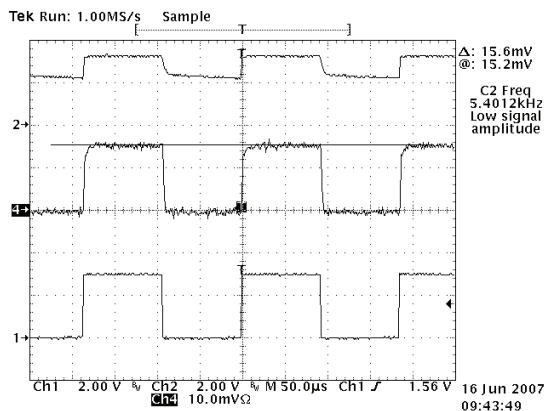

**PWM 50% Duty Cycle 5kHz**  
 CH1: PWM Signal CH2: Anode of LED  
 CH4: LED current 10mA/div

**TYPICAL PERFORMANCE SP7122A**

The quiescent current is part of the total output current

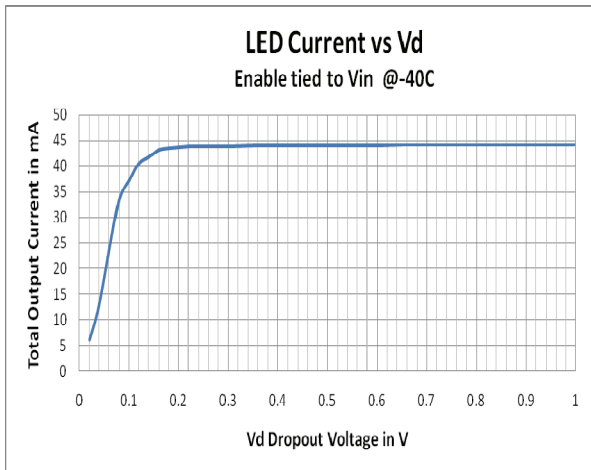

**IOUT is for 3 Channels 15mA per channel**

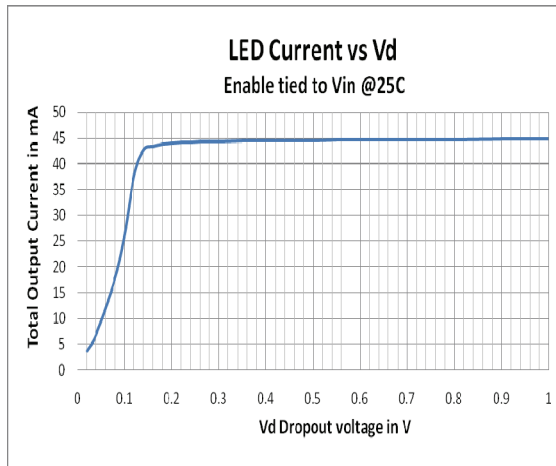

**IOUT is for 3 Channels 15mA per channel**

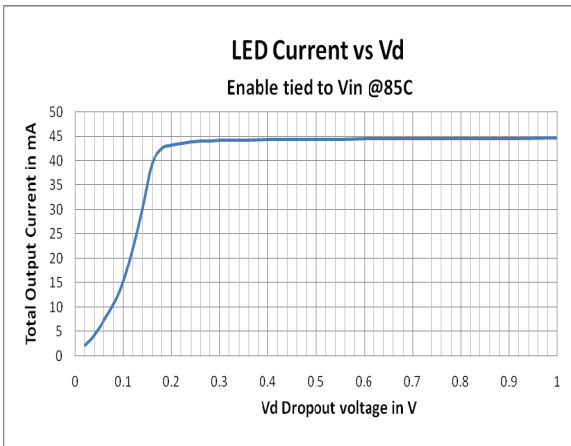

**IOUT is for 3 Channels 15mA per channel**

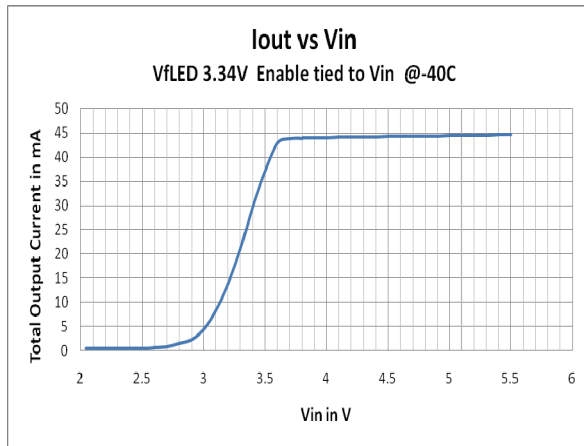

**IOUT is for 3 Channels 15mA per channel**

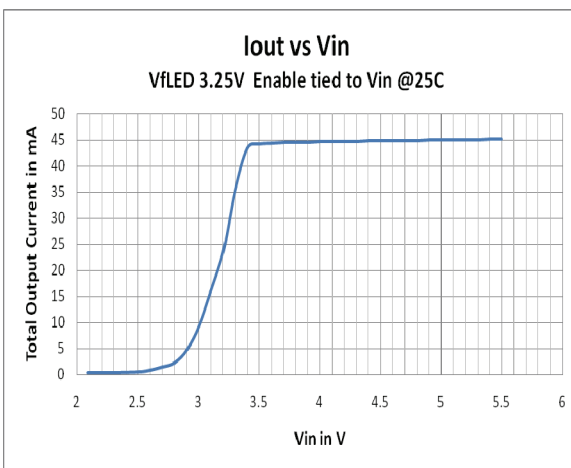

**IOUT is for 3 Channels 15mA per channel**

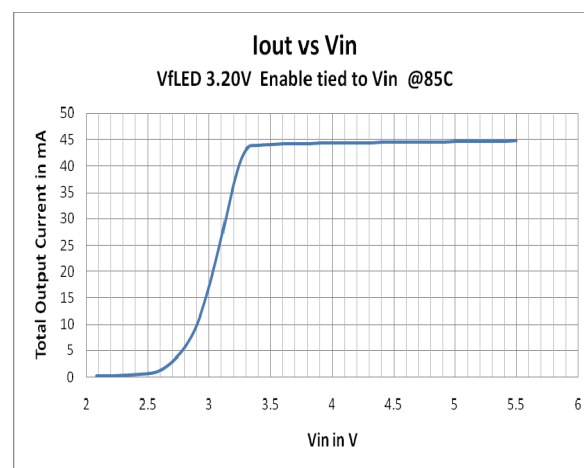

**IOUT is for 3 Channels 15mA per channel**

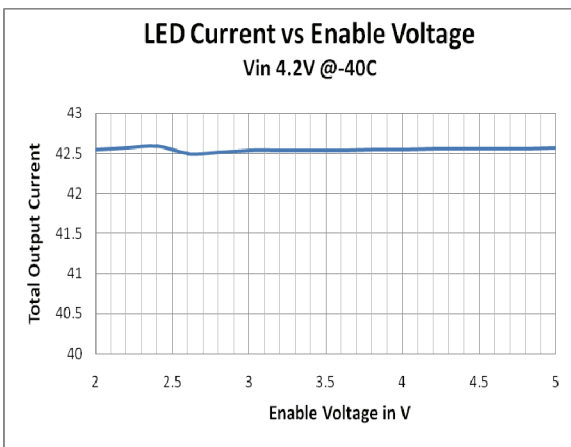

**IOUT is for 3 Channels 15mA per channel**

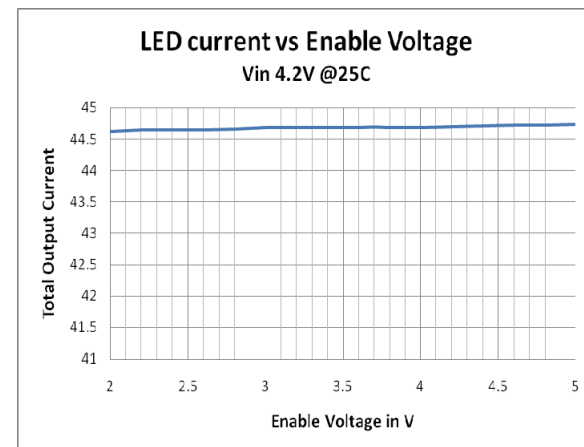

**IOUT is for 3 Channels 15mA per channel**

The quiescent current is part of the total output current

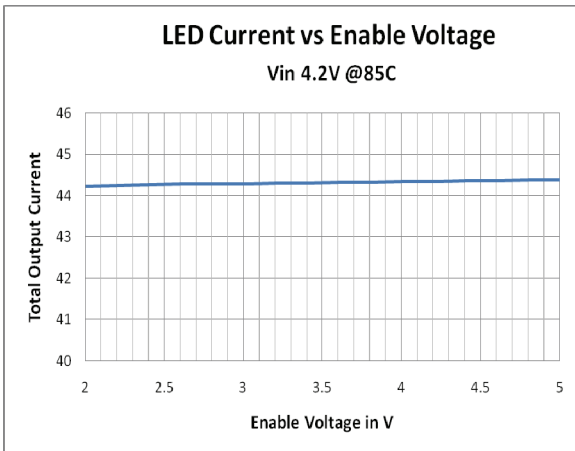

*I<sub>OUT</sub> is for 3 Channels 15mA per channel*

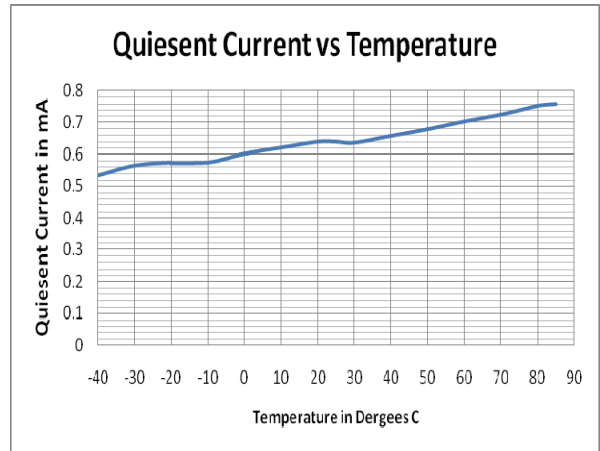

*I<sub>OUT</sub> is for 3 Channels 15mA per channel*

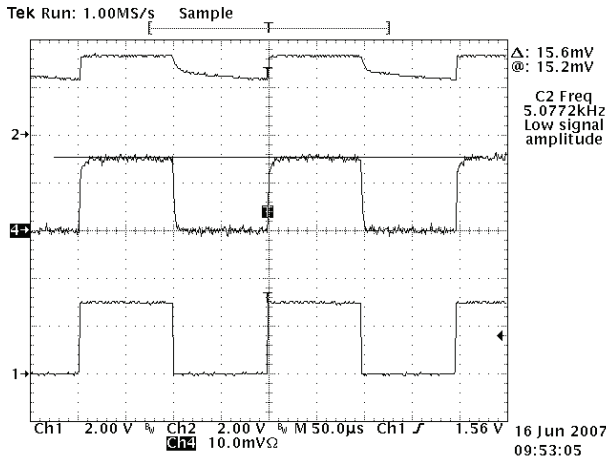

**50% Duty Cycle 5KHz PWM**

CH1: PWM Signal CH2: Anode of LED  
CH4: LED current 10mA/div

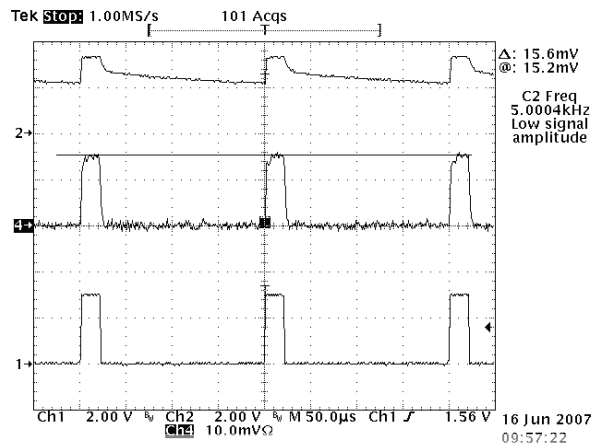

**Low duty cycle 5KHz**

CH1: PWM Signal CH2: Anode of LED  
CH4: LED current 10mA/div

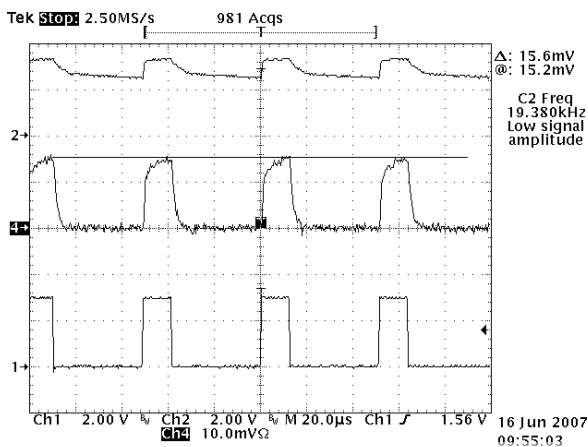

**Minimum On time 15μS 20kHz PWM**

CH1: PWM Signal CH2: Anode of LED  
CH4: LED current 10mA/div

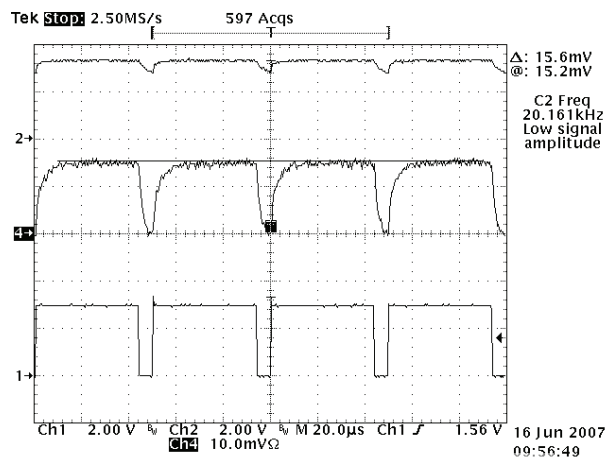

**High Duty Cycle 20kHz**

CH1: PWM Signal CH2: Anode of LED  
CH4: LED current 10mA/div

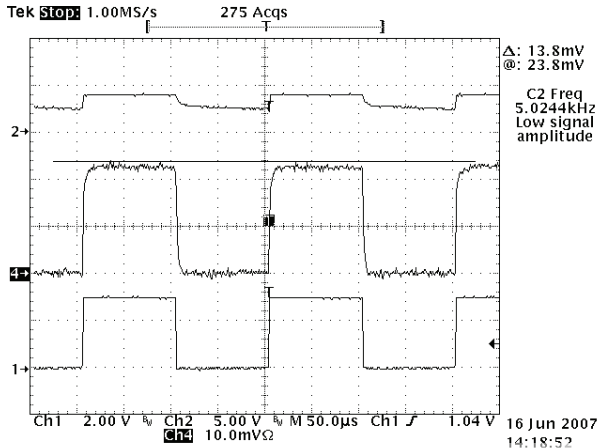

**PWM 50% Duty Cycle Single LED 5kHz**  
 CH1: PWM Signal CH2 Anode of LED  
 CH4: LED current 20mA/div

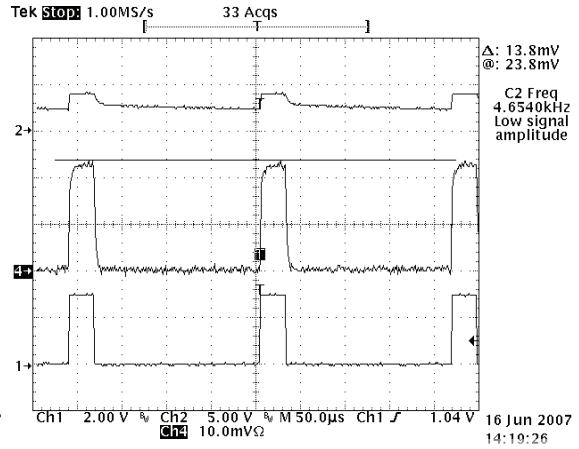

**PWM Low Duty Cycle Single LED 5kHz**  
 CH1: PWM Signal CH2 Anode of LED  
 CH4: LED current 20mA/div

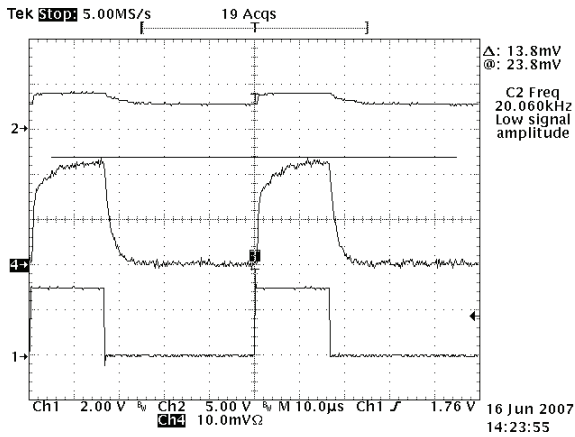

**PWM Minimum on time 15µS Single LED 20kHz**  
 CH1: PWM Signal CH2 Anode of LED  
 CH4: LED current 20mA/div

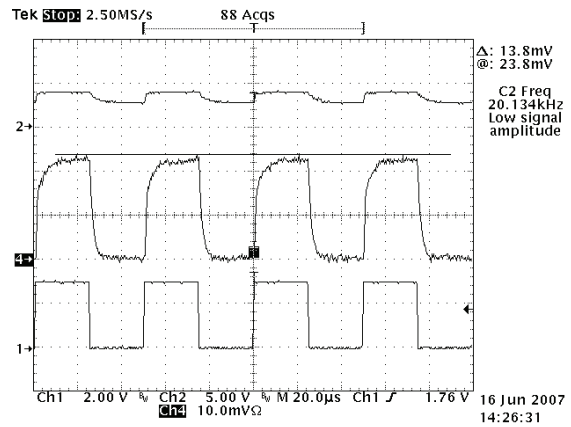

**PWM 50% Single LED 20kHz**  
 CH1: PWM Signal CH2 Anode of LED  
 CH4: LED current 20mA/div

The quiescent current is part of the total output current

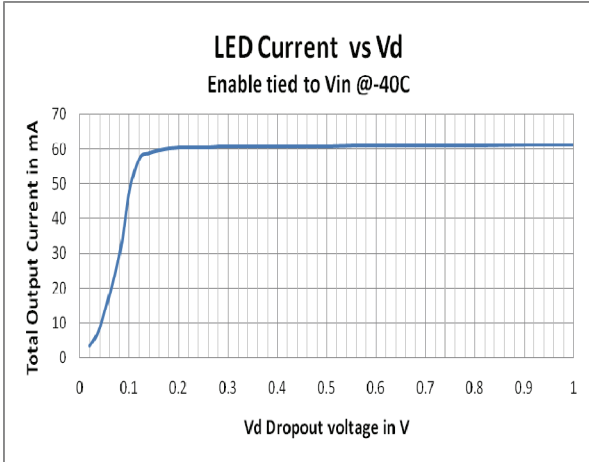

***I<sub>OUT</sub> is for 3 channels 20mA per channel***

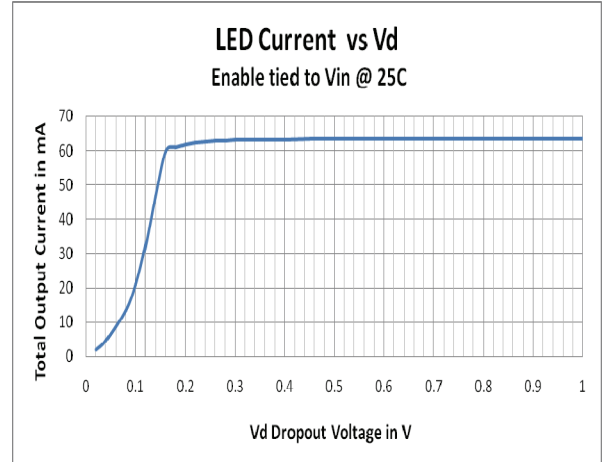

***I<sub>OUT</sub> is for 3 channels 20mA per channel***

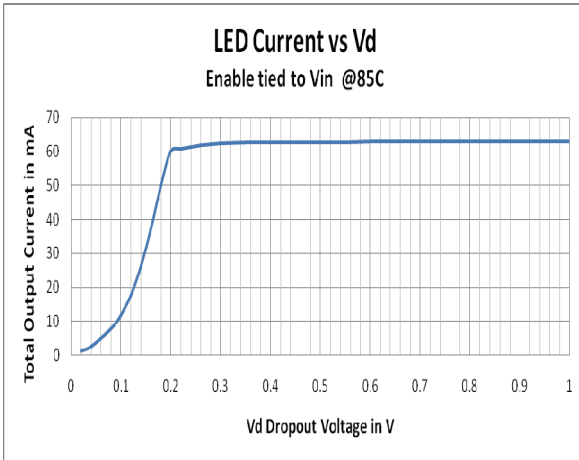

***I<sub>OUT</sub> is for 3 channels 20mA per channel***

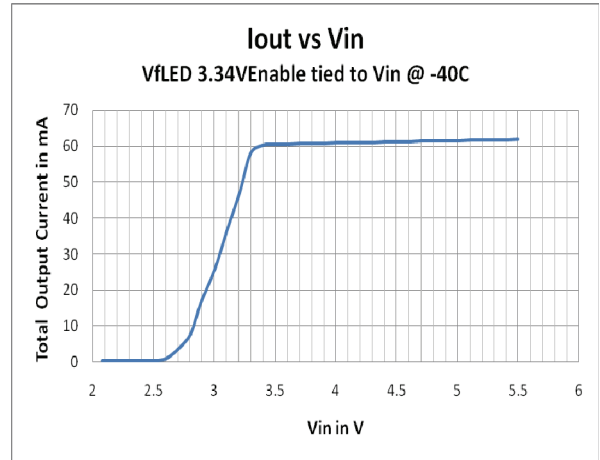

***I<sub>OUT</sub> is for 3 channels 20mA per channel***

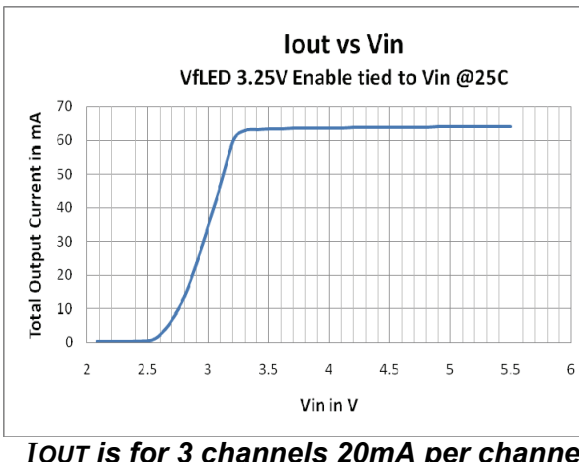

***I<sub>OUT</sub> is for 3 channels 20mA per channel***

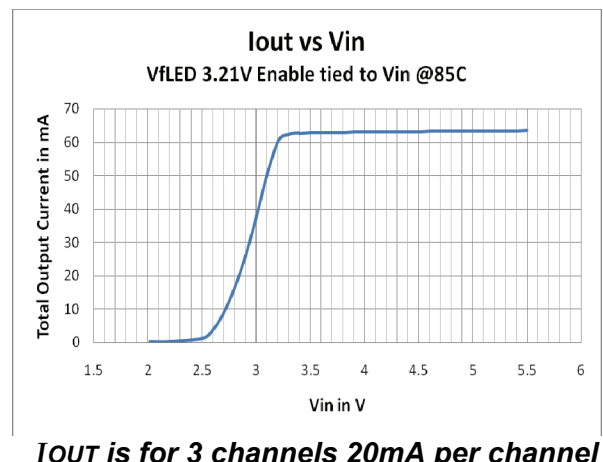

***I<sub>OUT</sub> is for 3 channels 20mA per channel***

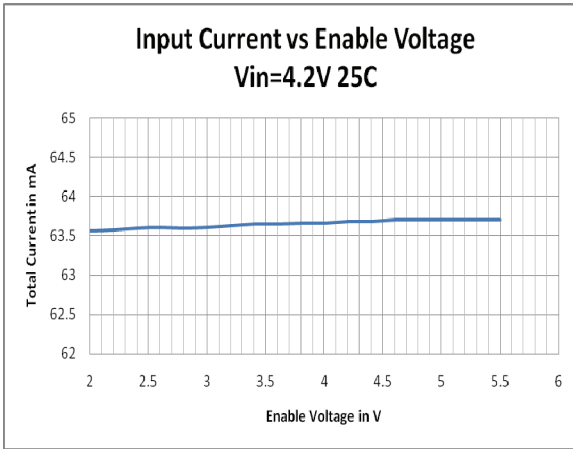

*I<sub>OUT</sub> is for 3 channels 20mA per channel*

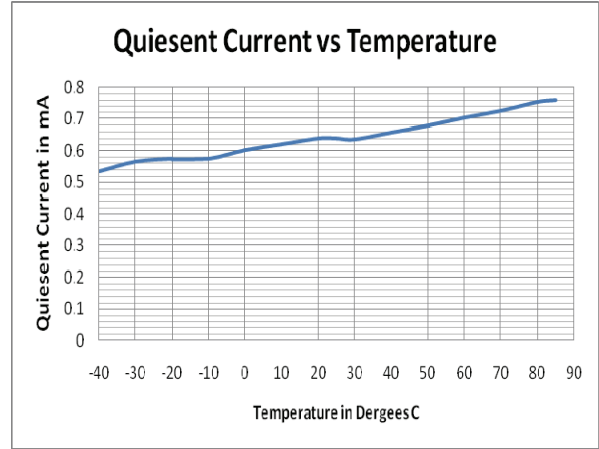

*I<sub>OUT</sub> is for 3 channels 20mA per channel*

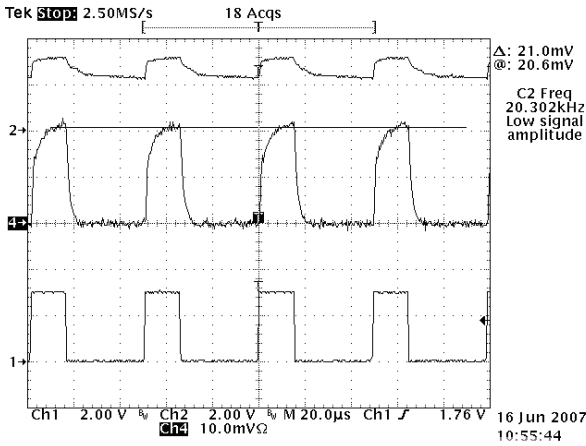

**PWM Minimum on time 15µs 20kHz**  
 CH1: PWM Signal CH2: Anode of LED  
 CH4: LED current 10mA/div

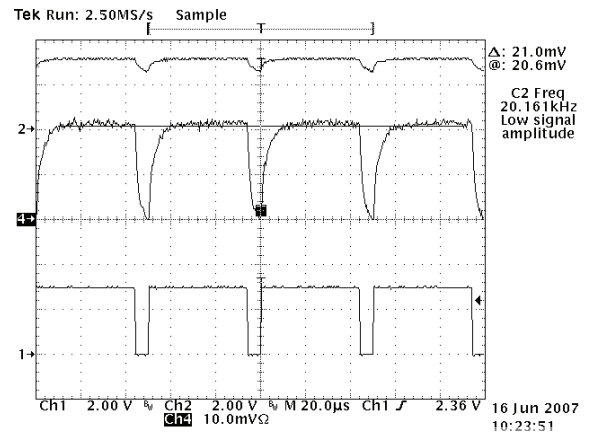

**PWM High Duty Cycle 20kHz**  
 CH1: PWM Signal CH2: Anode of LED  
 CH4: LED current 10mA/div

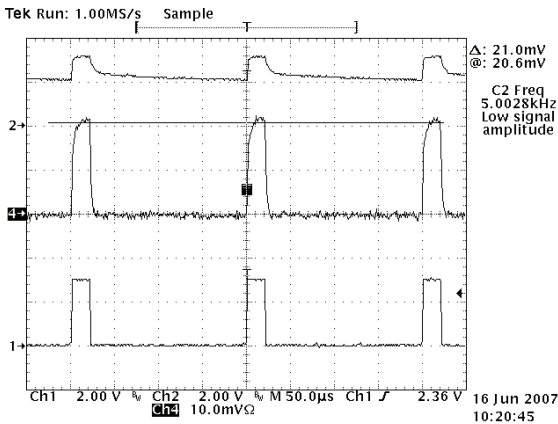

**PWM Low Duty Cycle 5kHz**  
 CH1: PWM Signal CH2: Anode of LED  
 CH4: LED current 10mA/div

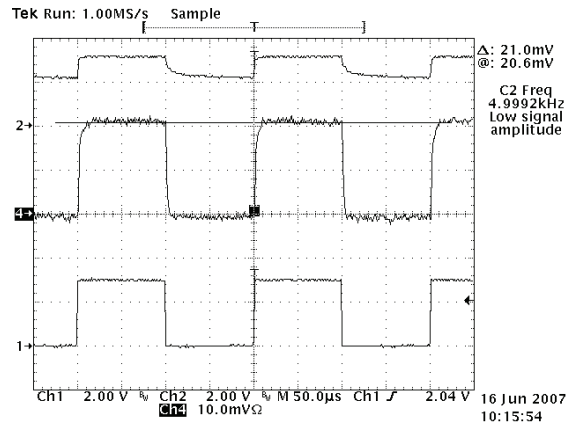

**PWM 50%Duty Cycle 5kHz**  
 CH1: PWM Signal CH2: Anode of LED  
 CH4: LED current 10mA/div

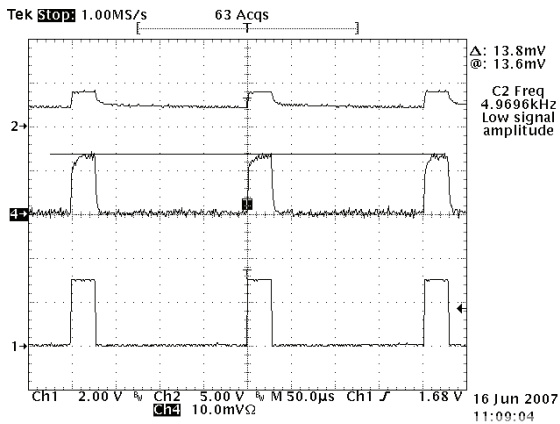

**PWM Low Duty Cycle Single LED 5kHz**  
 CH1: PWM Signal CH2 Anode of LED  
 CH4: LED current 50mA/div

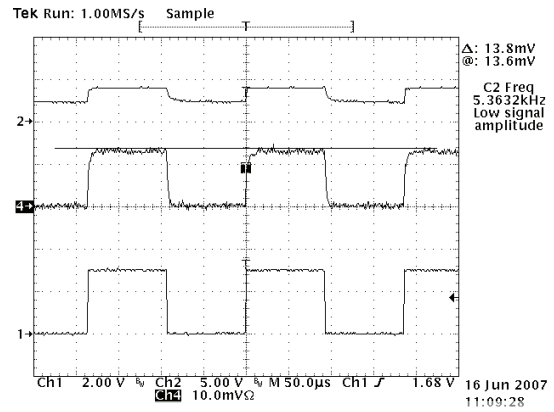

**PWM 50% Duty Cycle Single LED 5kHz**  
 CH1: PWM Signal CH2 Anode of LED  
 CH4: LED current 50mA/div

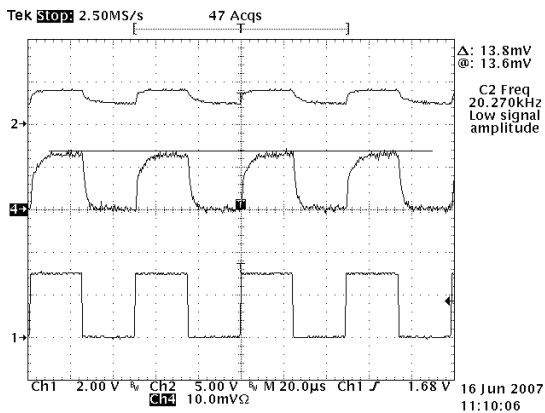

**PWM 50% Duty Cycle Single LED 20kHz**  
 CH1: PWM Signal CH2 Anode of LED  
 CH4: LED current 50mA/div

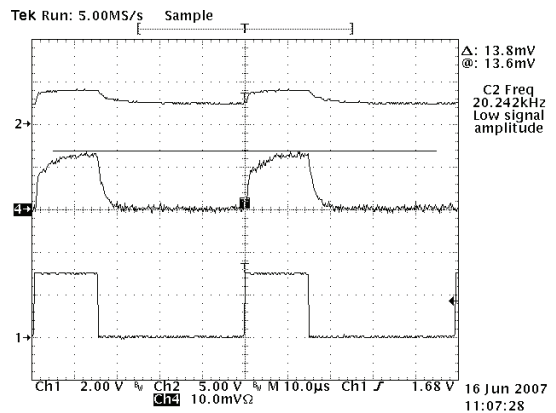

**PWM Minimum Duty Cycle 15μs Single LED 20kHz**  
 CH1: PWM Signal CH2 Anode of LED  
 CH4: LED current 50mA/div



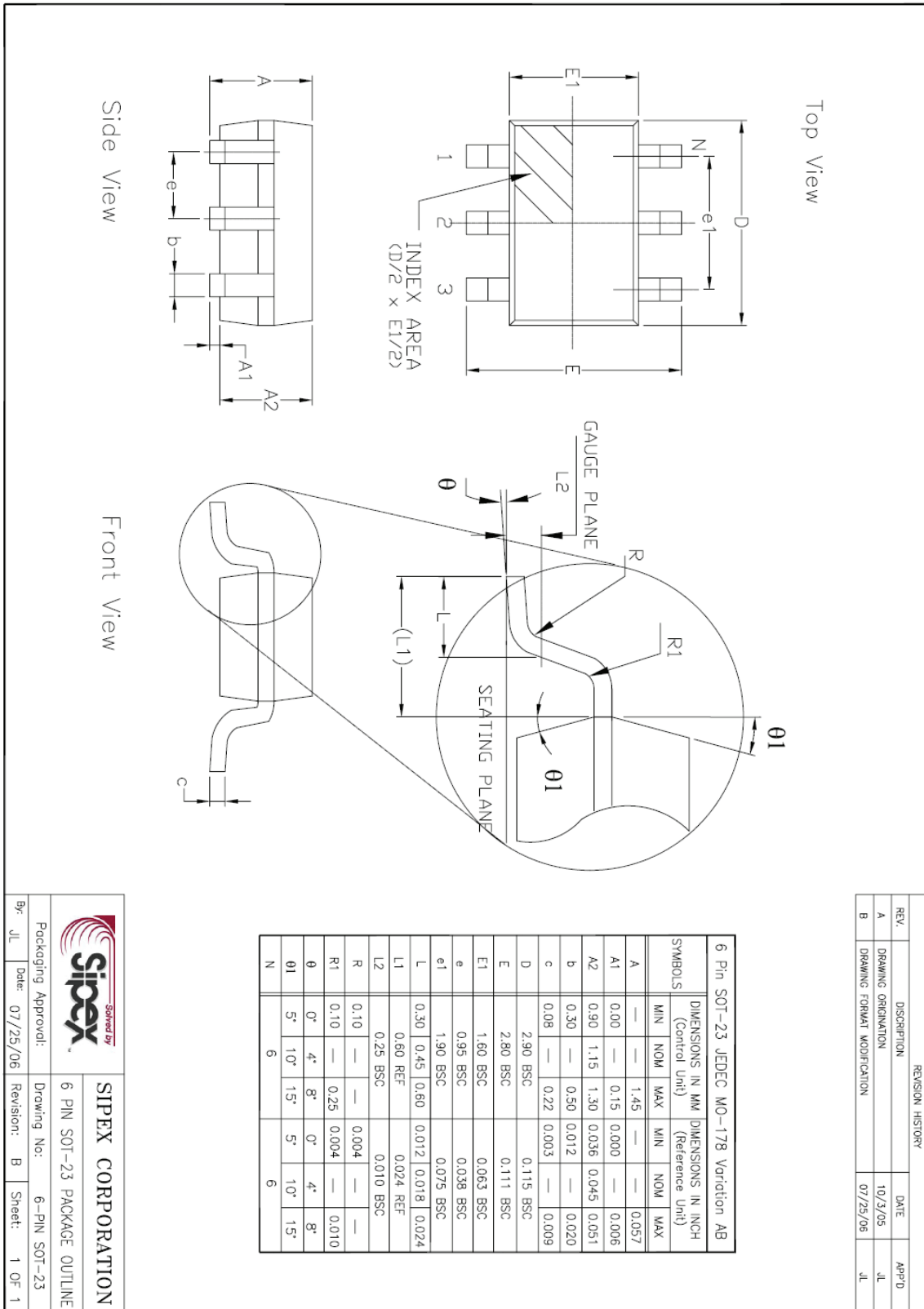

REVISION HISTORY			
REV.	DESCRIPTION	DATE	APP'D
A	DRAWING ORIGINATION	10/23/05	JL
B	DRAWING FORMAT MODIFICATION	07/25/06	JL

**SIPEX CORPORATION**  
 Packaging Approval: 6 PIN SOT-23 PACKAGE OUTLINE  
 Drawing No: 6-PIN SOT-23  
 By: JL Date: 07/25/06 Revision: B Sheet: 1 OF 1

Part Number	Temp Range	Package Type	RoHS/Lead Free	Output Current per Channel	# of Channels	$\Theta_{JA}$ ( $^{\circ}\text{C}/\text{W}$ )	Moisture Sensitivity Level
SP7120AEK-L/TR	-40 $^{\circ}\text{C}$ to +85 $^{\circ}\text{C}$	SOT23-6	Yes	15mA	2	190	L1 @ 260 $^{\circ}\text{C}$
SP7120BEK-L/TR	-40 $^{\circ}\text{C}$ to +85 $^{\circ}\text{C}$	SOT23-6	Yes	20mA	2	190	L1 @ 260 $^{\circ}\text{C}$
SP7120CEK-L/TR	-40 $^{\circ}\text{C}$ to +85 $^{\circ}\text{C}$	SOT23-6	Yes	25mA	2	190	L1 @ 260 $^{\circ}\text{C}$
SP7122AEK-L/TR	-40 $^{\circ}\text{C}$ to +85 $^{\circ}\text{C}$	SOT23-6	Yes	15mA	3	190	L1 @ 260 $^{\circ}\text{C}$
SP7122BEK-L/TR	-40 $^{\circ}\text{C}$ to +85 $^{\circ}\text{C}$	SOT23-6	Yes	20mA	3	190	L1 @ 260 $^{\circ}\text{C}$
SP7122CEK-L/TR	-40 $^{\circ}\text{C}$ to +85 $^{\circ}\text{C}$	SOT23-6	Yes	25mA	3	190	L1 @ 260 $^{\circ}\text{C}$

Pack quantity is 2500 for SOT23-6 tape and reel.

For further assistance:

Email: [Sipexsupport@sipex.com](mailto:Sipexsupport@sipex.com)  
 WWW Support page: <http://www.sipex.com/content.aspx?p=support>  
 Sipex Application Notes: <http://www.sipex.com/applicationNotes.aspx>



### Sipex Corporation

Headquarters and  
Sales Office  
233 South Hillview Drive  
Milpitas, CA95035  
tel: (408) 934-7500  
FAX: (408) 935-7600

Sipex Corporation reserves the right to make changes to any products described herein. Sipex does not assume any liability arising out of the application or use of any product or circuit described herein; neither does it convey any license under its patent rights nor the rights of others.