

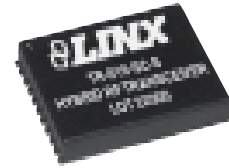

HIGH-PERFORMANCE
SC-S SERIES
 RF TRANSCEIVER



WIRELESS MADE SIMPLE

SC-S TRANSCEIVER MODULE DESIGN GUIDE

DESCRIPTION:

The TR-XXX-SC-S transceiver module is designed for the cost-effective, bi-directional transfer of wireless information. The Transceiver utilizes an advanced synthesized superhet architecture and has direct interface for analog or digital information, UART-compatible data output, RSSI, low power consumption, wide operational voltage, on-board TX/RX switch, SAW front-end filter, and many other useful features. Fast turnaround times, along with the support for data rates to 33.6Kbps, make the transceiver suitable for a wide range of applications. Housed in a compact SMT package, the transceiver requires no tuning or external RF components (except antenna), allowing for straightforward application, even by engineers lacking previous RF experience.

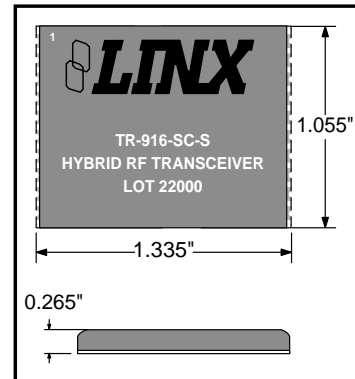

PHYSICAL DIMENSIONS

FEATURES

- Direct interface for analog or digital information
- Precision crystal-controlled synthesized architecture
- Transparent serial input
- UART-compatible data output
- Built-in data squelching
- High data-rate: up to 33,600bps
- Wide-range analog capability including audio
- Single-antenna-ready (No TX/RX switch required)
- Output power and harmonics are compatible with FCC regulations
- Differential LO dramatically reduces unintended radiation
- Output power can be programmed with an external resistor
- Good sensitivity (-95dBm typical at 10⁻⁵ BER)
- SAW filter on front end for superior out-of-band rejection
- Received signal strength indication
- Fast start-up and turnaround time
- Wide input voltage range (2.7 to 13 VDC)
- Very low power consumption (as low as 12 mA)
- Power-down mode - 50µA max (V_{CC} @ 5V)

APPLICATIONS

- Small Area Networks
- Wireless RS:232/485 Modems
- 2-Way Paging
- Remote Control W/ Confirmation
- Telemetry
- Data Collection
- Home/Industrial Automation
- Long-Range RFID
- Robotics
- Wire Elimination

ORDERING INFORMATION

PART #	DESCRIPTION
TR-XXX-SC-S	SC SMT Transceiver
XXX=433.92, 868, 916MHz	

PERFORMANCE DATA TR-XXX-SC-S

*ABOUT THESE MEASUREMENTS

The performance parameters listed below are based on module operation at 25°C from a 5VDC supply unless otherwise noted.

Parameter	Designation	Min	Typ	Max	Units	Notes
POWER SUPPLY						
Operating Voltage	VCC (pin 10)	2.7		13	VDC	
Current Consumption	Icc					
TX Mode		12		29	mA	15
RX Mode		10	13	15	mA	15
Sleep Mode			50		uA	8
ENVIRONMENTAL						
Operational Temp.		0		70	°C	
TRANSMIT SECTION						
Center Frequency	Fc		SEE TABLE 1		MHz	
Fc Tolerance		-50		+50	KHz	1
Output Power	Po	-3	-0	+4	dBm	2,3
Output-Power Control Range			15		dB	2,4,8
Harmonic Emissions	Ph		-43		dBc	
Spurious Emissions	compatible with FCC part 15					
Frequency Deviation		90	110	130	KHz	5
Data Rate		300		33,600	Bps	8
Audio Modulation Bandwidth		.15		17	KHz	7,8
Modulation Voltage						
Digital (Mark)		3	5	5.2	VDC	9
Digital (Space)		0	0		VDC	
Analog		0		3	Vp-p	10
RECEIVE SECTION						
LO Frequency	Flo		SEE TABLE 1		MHz	
Flo Tolerance		-50		+50	KHz	
Local Oscillator Feedthru			-65	-50	dBm	2
Spurious Emissions	compatible with FCC part 15					
Receive Sensitivity		-90	-95	-100	dBm	6,15
Data Rate		300		33,600	Bps	8
Required Transition Interval				3.5	ms	8,14
Audio Bandwidth		.15		17	KHz	7,8
Audio Level			180		mVp-p	8
RSSI DC Output Range			.7 to 2.5		V	8
RSSI Gain	Grssi		27		mV/dB	8
RSSI Dynamic Range			65		dB	8
ANTENNA PORT						
Designed for match			50		ohms	8
TIMING						
Power-on to Valid Receive			6	8	ms	8, 9,11
Power-on to Valid Transmit			3	5	ms	8, 9,11
RX to Valid TX Switching			3	5	ms	8,9,12
TX to Valid RX Switching			4	6	ms	8,9,13

NOTES:

- 1) Center frequency measured while modulated with a 0-5V square wave.
- 2) Into a 50-ohm load.
- 3) LVLADJ open.
- 4) Maximum power when LVLADJ open, minimum power when LVLADJ grounded.
- 5) TXDATA pin modulated with a 0-5V square wave.
- 6) For 10^{-5} BER at 9,600 baud.
- 7) The audio bandwidth is wide to accommodate the needs of the data slicer. In audio applications, audio quality may be improved by using a low pass filter rolling off at the maximum frequency of interest.
- 8) These parameters are only characterized and not tested.
- 9) The SC is optimized for 0-5V modulation when sending digital data. 0-3V modulation is possible but will slightly reduce system sensitivity and increase settling times.
- 10) Analog signals including audio should be AC-coupled. Signals in excess of 3V will cause distortion.
- 11) Time to transmitter or receiver readiness from the application of power to VIN or PDN going high.
- 12) Time from the TXEN going high and RXEN going low to the transmitter being ready to transmit data.
- 13) Time from the RXEN going high and TXEN going low to valid receiver data output.
- 14) Maximum time without a data transition.
- 15) Linx will not reject for better performance than stated.

MODEL	Center Frequency		UNITS
	TX	RX LO	
TR-433-SC-S	Not Released		MHz
TR-868-SC-S	Not Released		MHz
TR-916-SC-S	916.48	905.78	MHz

Table 1



CAUTION
 This product incorporates numerous static-sensitive components. Always wear an ESD wrist strap and observe proper ESD handling procedures when working with this device. Failure to observe this precaution may result in module damage or failure.

TYPICAL PERFORMANCE GRAPHS

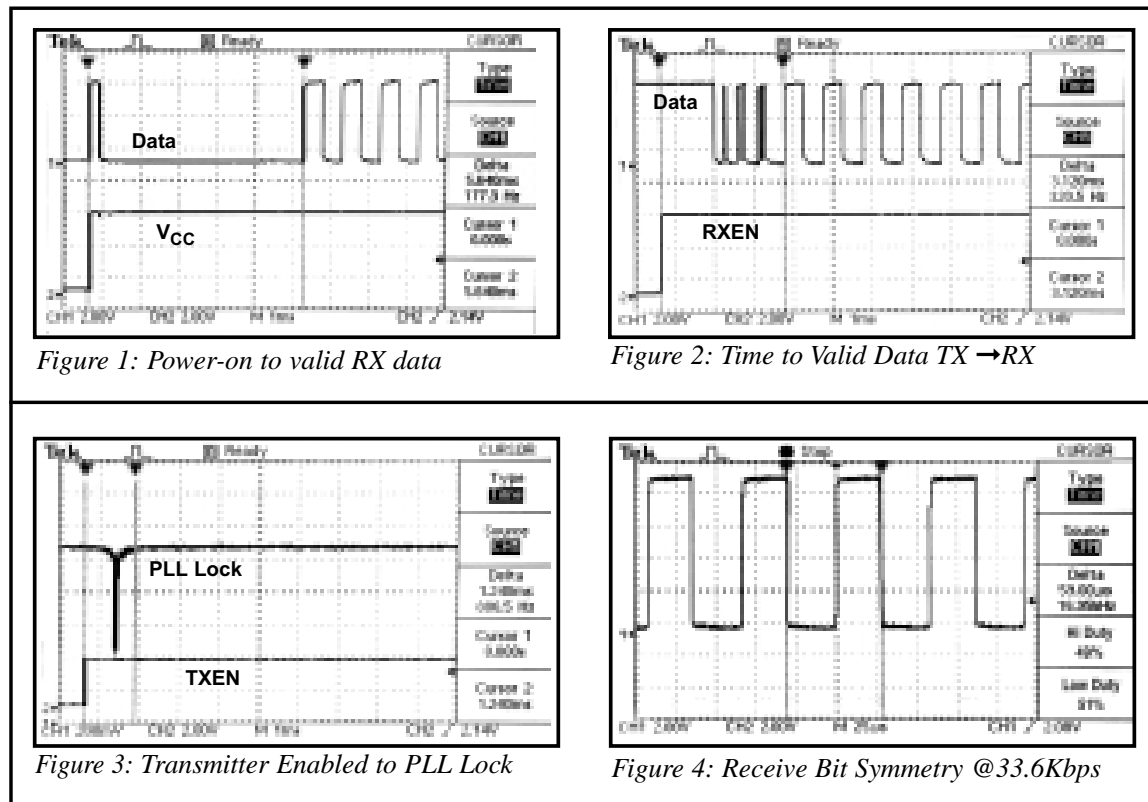

PIN DESCRIPTION

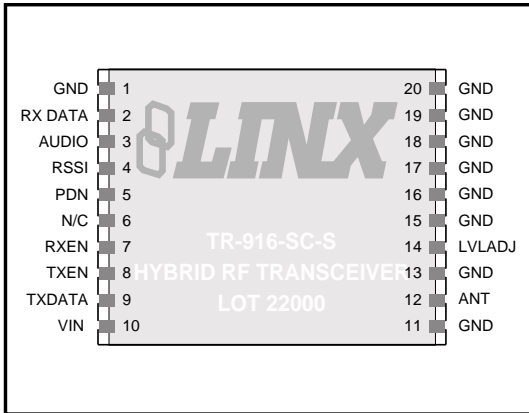

Figure 5: SC-S Series Pinouts
(viewed looking down on top cover)

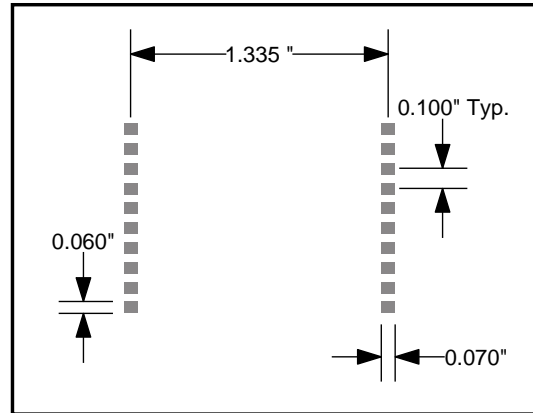

Figure 6: Recommended pad layout

PIN#	Pin Title	Description
1,11,13 15-20	Ground	Module Grounds Tie to Common Groundplane
2	RXDATA	Recovered Data Output
3	AUDIO	Recovered Analog Output
4	RSSI	Received Signal Strength Indicator
5	PDN	Logic Low Powers Down The Transceiver
6	N/C	Not Implemented Do Not Connect
7	RXEN	Receiver Enable Pin Active High Pull Low When in TX
8	TXEN	Transmitter Enable Pin Active High Pull Low When in RX
9	TXDATA	Analog or Digital Content to be Transmitted
10	VIN	2.7-13VDC Supply
12	ANT	50Ω Antenna Port TX/RX Switch Inside Module
14	LVLADJ	Open for Maximum TX Power Insert Resistor to Reduce by up to 15dB

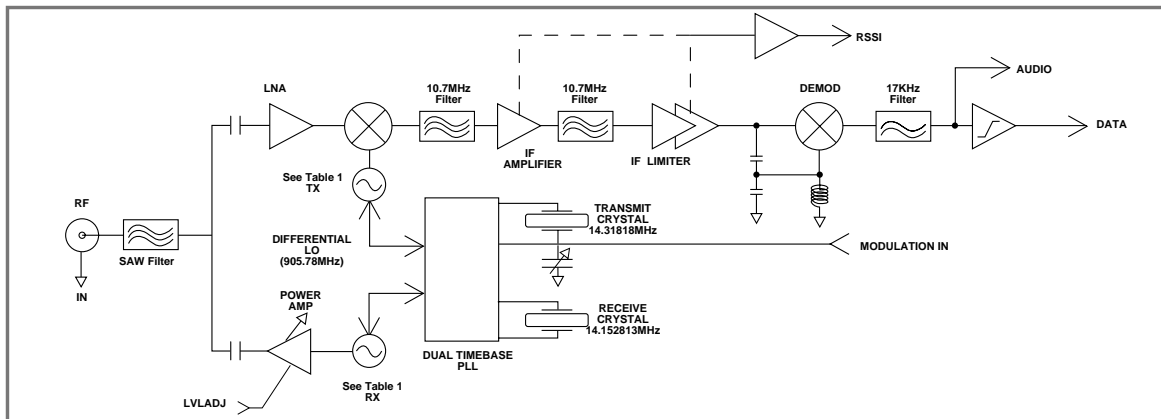

Figure 7: SC-S Series Block Diagram

DESCRIPTION

The TR-XXX-SC-S module is a single-channel, half-duplex transceiver designed for the wireless transmission of digital or analog information over distances of <500 feet outside and <200 feet inside.

No external components (excluding an antenna) are required. The module incorporates an on-board switch allowing the use of a single antenna. Linx offers a wide selection of antennas designed for use with the transceiver module.

The transceiver is half-duplex; therefore, it can only be operated in one mode at a time: either transmit mode or receive mode. When transmitting, the receiver is powered down. Likewise, the transmitter is powered down in receive mode.

The transmit section of the transceiver is capable of producing up to 1mW of output power while maintaining harmonics and spurious emissions within legal limits. The power amplifier can be adjusted over a 15dB adjustment range via the LVLADJ pin. This is very useful for optimizing a product during FCC testing.

The transmitter directly modulates the carrier with the baseband signal present at the TXDATA pin. If the signal is analog in nature, it will FM modulate the carrier. If the signal is digital, the modulation method becomes FSK. In either case the carrier's peak deviation is determined by the modulating signal's amplitude.

The receive section of the transceiver is capable of recovering a signal as low as -95dBm (typical). The receiver operates in a single conversion superhet configuration, with an IF of 10.7 MHz. A quadrature demodulator is used to recover the baseband analog signal from the carrier. This analog signal is low-pass filtered and then made externally available to the user via the audio pin. It is also passed to the data slicer for squaring of digital content.

The transceiver has an on-board voltage regulator that regulates the internal VCC to 3.0V. This allows a wide operating voltage range of 2.7V to 13V. At 2.7V, the internal regulator acts as a saturated switch, directly passing voltage through to the internal electronics. The PDN pin can be used to put the transceiver into a low-current sleep mode (<50uA).

TRANSMITTER OPERATION

The transceiver's FM/FSK transmitter section is capable of generating 1mW of output power into a 50-ohm load.

The transmitter is comprised of a VCO and a crystal-controlled frequency synthesizer. The frequency synthesizer, referenced to a precision crystal, locks the VCO to achieve a high-Q, low phase-noise oscillator.

FM modulation is achieved by direct modulation of the reference crystal. By modulating the transmitter in this manner, a wide modulation bandwidth is achieved. If the transmitter LO were modulated, the frequency synthesizer would track out modulation within the bandwidth of the loop filter (this is a common limitation of most synthesized FM transmitters).

When the transmitter will be used to transmit digital data, the TXDATA is best driven from a 5-volt source. The transmitter is designed to give an average deviation of 110kHz with a 5V square wave input. It is possible to successfully modulate the transceiver with a level as low as 3 volts; however, the reduced carrier deviation will cause a slight loss in receiver sensitivity and a 10 to 20% increase in settling times.

Analog sources such as audio should provide a 3V P-P maximum waveform and should be AC-coupled into the TXDATA pin. The size of the coupling capacitor should be large enough to insure the passage of all desired frequencies. Since the modulation voltage applied to the TXDATA pin determines the carrier deviation, distortion can occur if the TXDATA pin is over-driven. The actual level of the input waveform should be adjusted to achieve optimum in-circuit results.

The transmitter's output power is not affected by supply voltage but it can be externally adjusted from approximately -15dBm to 0dBm using the LVLADJ pin. When the LVLADJ pin is open, power is at its max and the transmitter will draw 25mA typically. When LVLADJ is at 0V, power is at its minimum and the transmitter will draw 13mA typically. An internal 1K pull-up resistor holds LVLADJ high when the transceiver is in transmit mode so no external components are needed to obtain maximum power. To lower the transmit power, simply place a resistor from the LVLADJ pin to ground to form a voltage divider. Linx recommends placing pads for this resistor in case the power needs to be later reduced for legal compliance.

RECEIVER OPERATION

The receiver is configured as a single conversion superhet FM receiver with a baseband analog bandwidth of 17kHz.

Low-level RF signals are filtered at the front end by a SAW band-pass filter. This filter reduces the signal levels of interfering transmitters such as pager towers and cell phones.

The filtered signal is amplified and down-converted to the 10.7 MHz IF by mixing it with a LO frequency generated by a PLL locked differential VCO. Then the 10.7 MHz IF is amplified, filtered, and finally demodulated to recover the analog baseband signal originally transmitted. The analog baseband output is low-pass filtered and then made available externally via the audio pin. The signal is also squared by a proprietary data slicer for output of digital information at the RX Data pin. The data slicer is capable of recreating squared waveforms in the 150Hz to 17kHz band, giving a data-rate bandwidth of 300bps to 33.6Kbps.

RECEIVER OPERATION (Cont.)

The receiver features a RSSI output (Received Signal Strength Indicator). The RSSI pin gives a linear voltage output corresponding to incoming signal level. The RSSI output has many valuable uses including interference assessment, signal strength indication, external data squelching and qualification, and transmitter presence indication. Since RSSI values vary from part to part and correspond to signal strength and not necessarily distance, the pin is not recommended for range-finding applications.

When RF transmissions are not present, or when the received signal strength is too low to ensure proper demodulation, the data output is squelched to a continuous high state. This ensures compatibility with common serial UART's. It is important to note that the squelch level is set just over the transceiver's internal noise threshold and any external RF activity above that threshold will produce hashing on the transceiver output. While the data output is qualified high in low-noise environments, the designer should always plan for the potential of hashing. This is a key area of consideration when planning the overall protocol structure.

The two most obvious ways a wireless link differs from a wire are timing and susceptibility to interference. Brief reviews of each of these critical areas follows:

INTERFERENCE CONSIDERATIONS

It must be recognized that many bands are widely used, and the potential for conflict with other unwanted sources of RF is very real. Despite careful design, all RF products are at risk from interference.

Interference can manifest itself in many ways. Low-level interference will produce noise and hashing on the output and reduce the link's overall range. Thanks to the capture properties of an FM system, the transceiver will still function when an intended signal is present at a higher level than the interference.

Another type of interference can be caused by higher-powered devices such as hopping spread-spectrum devices. Since these devices move rapidly from frequency to frequency they will usually cause short, intense losses of information. Such errors are referred to as bursting errors and will generally be dealt with through protocol.

High-level interference is caused by products sharing the same frequency or from near-band high-power devices. Fortunately, this type of interference is less common than those mentioned previously, but in severe cases can prevent all useful function of the affected device.

Although technically it is not interference, multipath is also a factor to be understood. Multipath is a term used to refer to the signal cancelation effects that occur when RF waves arrive at the receiver in different phase relationships. This is particularly a factor in interior environments where objects provide many different reflection paths. Multipath results in lowered signal levels at the receiver and thus shorter useful distances for the link.

A spectrum analyzer is the primary tool of the RF engineer for assessing interference sources and levels, but is often not available due to its cost. Fortunately, the RSSI voltage output can also be used to determine the presence and strength of interference during the development process.

TIMING CONSIDERATIONS

There are three general areas of timing that are important to consider when designing with the transceiver: the actual time value for each is listed under the "Performance Specifications" section of this document.

1. Start-up time

Start-up time is the time to transmitter or receiver readiness from the application of power to the VIN pin on the PDN pin going high.

Transmitter readiness is defined as the presence of a fully locked carrier.

Receiver readiness is determined by valid data at the RXDATA pin. (This assumes an incoming data stream.)

2. Mode turnaround time

This is the time taken by a powered-up module to switch between modes.

The RX-to-TX time is measured as the time from the TXEN pin going high and the RXEN pin going low to the transmitter being ready to transmit data. Here again, transmitter readiness is defined as the presence of a fully locked carrier.

The TX-to-RX time is measured as the time from the RXEN pin going high and the TXEN pin going low to the receiver's data output being valid. (This assumes valid incoming data.)

It is important to note that TXEN and RXEN should never be high at the same time. This will invalidate the timing parameters and may cause illegal emissions from the transceiver.

3. Required transition interval.

This is the maximum amount of time that can elapse without a transition on the TX data pin.

It is always important to think of data in both the analog and the digital domain. Because the data stream is asynchronous and no particular format is imposed, it is possible for the data to meet the baud-rate requirements of the module and yet violate the analog frequency parameters. For example, if a 255 (0FF hex) is being sent continuously the receiver would view the data as a DC level. The receiver would hold that level until a transition was required to meet the minimum frequency requirement. If no transition occurred, data integrity could not be guaranteed. Thus, while no particular signal structure or code-balancing requirement is imposed, the designer must insure that both analog and digital signals have transitions suitable to meet the required transition interval specification.

A TYPICAL SYSTEM EXAMPLE

To properly apply the transceiver, it is critical to understand and respect the differences that exist between a wired and a wireless environment. At every point in this system, there are timing and data-corruption issues that should be understood and accounted for. The following section provides a basic outline of the typical flow of events in a link incorporating SC series modules. While there are many alternate methodologies, this section illustrates many of the considerations previously mentioned.

It is important to note that the TR-XXX-SC-S does not encode or packetize the data in any manner. This transparency eliminates the issues of variable latency common to traditional radio modems and gives the designer tremendous flexibility in the structure of protocol. A drawback to this approach is that the performance and reliability of the link are in part determined by the quality of external software and hardware.

The SC series is a half-duplex transceiver, meaning it can only act as a transmitter or a receiver at any given time, but never both. Designing a system with a half-duplex transceiver can be a bit challenging because of the timing requirements when shifting between transmit and receive modes. A typical systems operation would be similar to the following:

1) Switch to transmit mode

The transceiver is placed in transmit mode by bringing TXEN high and RXEN low. The PDN pin must be open or pulled to VCC. Once the transceiver is placed in transmit mode, the synthesizer will begin trying to lock.

2) Wait for transmitter to stabilize

This step is necessary to allow the transmitter time to lock and stabilize. Several options are available during this time. The designer might choose to set a fixed delay equal to the worst-case stabilization time before sending data. Another method would be to send data immediately, knowing that it would not be valid until the transmitter had stabilized. Depending on packet size, the latter method may achieve faster turnaround times but would require more care from a protocol standpoint.

3) Transmit a packet

Structuring the data to be sent into small packets is highly recommended. That way, errors can be managed easily without affecting large amounts of data. Packets should be transmitted so that there is no space between bytes. When using a UART the following packet format is generally followed:

```
[ uart sync byte ] [ start byte ] [ data packet ]
```

The UART Sync Byte is used to ensure that the start-bit for the start byte will be accurately detected. It is a single byte with a value of 255 (0FF hex).

A Start Byte often follows the Sync Byte to intelligently qualify the Data Packet which will follow. Detection of the Start Byte would be performed by the computer or microcontroller connected to the transceiver.

4) Switch to receive mode

The transceiver is placed in receive mode by bringing RXEN high and TXEN low. The PDN pin must be open or pulled to VCC. Once the transceiver is placed in receive mode, the PLL will begin trying to lock.

5) Wait for receiver to stabilize

This step is necessary to allow the receiver time to stabilize. When the PLL is locked and the data slicer is stable, the transceiver is ready to receive valid data. During the settling time the receiver output may produce scraps of data; however, the data can only be considered reliable once the settling time has passed.

6) Receive a packet

The procedure here is protocol-dependent, but to illustrate let's consider the packet format outlined above being sent to a UART. A UART interprets the start-bit of a byte as a 1-0 transition. When the incoming data is 101010 or hash... it is hard to actually find the start bit. This problem is solved by the UART Sync Byte. The purpose of the Sync Byte is to create a high marking period of at least a byte-length so that the start bit of the following Start Byte can be correctly recognized.

The Start Byte following the Sync Byte is used by the receiving computer or microcontroller to intelligently identify the beginning of a data packet. The Start Byte value should be chosen so that it does not appear in the data stream. Otherwise, a receiver may "wake up" in the middle of a packet and interpret data in the packet as a valid Start Byte. There are many other, more complicated ways to organize the protocol if this restriction cannot be met.

There is always a possibility of bursting errors from interference or changing signal conditions causing corruption of the data packet, so some form of error checking should be employed. A simple checksum or CRC could be used. Once an error is detected the protocol designer may wish to simply discard the corrupt data or to develop a scheme for correcting it or requesting its retransmission.

The preceding steps indicate the general events involved in using the transceiver for a half-duplex communication application. To summarize, the system controller will basically run through the steps in order and then return to step 1, flipping back and forth between transmit and receive modes. As discussed, the designer must take into account the timing considerations of both the transmitting and receiving sides and carefully think through protocol issues to ensure product reliability under field conditions.

USING THE TR-XXX-SC-S FOR AUDIO APPLICATIONS

The SC series is optimized for the transmission of serial data; however, it can also be used very effectively to send a variety of simple and complex analog signals including audio. The SC-S is an excellent choice for applications requiring audio quality comparable to a radio or intercom. The ability of the SC-S to send combinations of audio and data also opens new areas of opportunity for creative design. In applications which require high-quality audio, the SC series may be used with a compandor to further improve SNR. In the cases where truly high fidelity audio is required, the SC-S will probably not be the best choice. For such applications, consider devices which have been optimized for audio.

The audio source should provide a 3V P-P maximum waveform and should be AC-coupled into the TXDATA pin. The size of the coupling capacitor should be large enough to insure the passage of all desired frequencies. Since the modulation voltage applied to the TXDATA pin determines the carrier deviation, distortion can occur if the TXDATA pin is over-driven. The actual level of the input waveform should be adjusted to achieve the optimum results for your application in your circuit.

The RXAUDIO output of the transceiver should be filtered and buffered to obtain maximum audio quality. For voice, a 3-4KHz low-pass filter is often employed. For broader-range sources such as music, a 12-17KHz cutoff may be more appropriate.

The SNR of the audio will depend on the bandwidth you select. The higher the SNR, the less "hiss" you will hear in the background. For the best SNR, choose the lowest filter cutoff appropriate for the intended signal.

POWER SUPPLY CONSIDERATIONS

The user must provide a clean source of power to the module to ensure proper operation. Power-supply noise will manifest itself as AM and FM noise and can significantly affect transceiver performance. Providing a clean power supply for the module should be a high design priority.

The TR-XXX-SC-S incorporates an on-board Low-Dropout Regulator allowing the module to operate over an input voltage range of 2.7 to 13 volts DC. The module's power-supply line should have bypass capacitors configured as shown in figure 8. Actual capacitor values will vary depending on noise conditions.

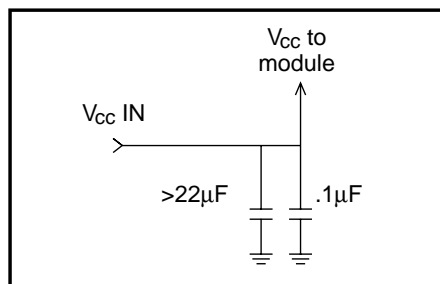

Figure 8: Suggested supply filter

BOARD LAYOUT CONSIDERATIONS

If you are at all familiar with RF devices, you may be concerned about specialized layout requirements. Fortunately, because of the care taken by Linx in the layout of the module's PCB, integrating a TR-XXX-SC-S transceiver into your design is very straightforward. By adhering carefully to a few basic design and layout rules, you can enjoy a trouble-free path to RF success.

Figure 6 shows the suggested PCB footprint for the SC-Series transceiver.

A groundplane (as large as possible) should be placed directly under the SC-S Transceiver. This groundplane can also be critical to the performance of your antenna.

The SC-S should, as much as reasonably possible, be isolated from all other components on your PCB. Specifically, high-frequency circuitry such as crystal oscillators should be kept as far away as possible from the module.

The trace from the transceiver to the antenna should be kept as short as possible. A simple trace is suitable for runs up to 1/8 inch for antennas with wide bandwidth characteristics. For longer runs or to avoid detuning a high-Q narrow bandwidth antenna such as a helical, use a 50-ohm coax or 50-ohm microstrip transmission line as described in the following section.

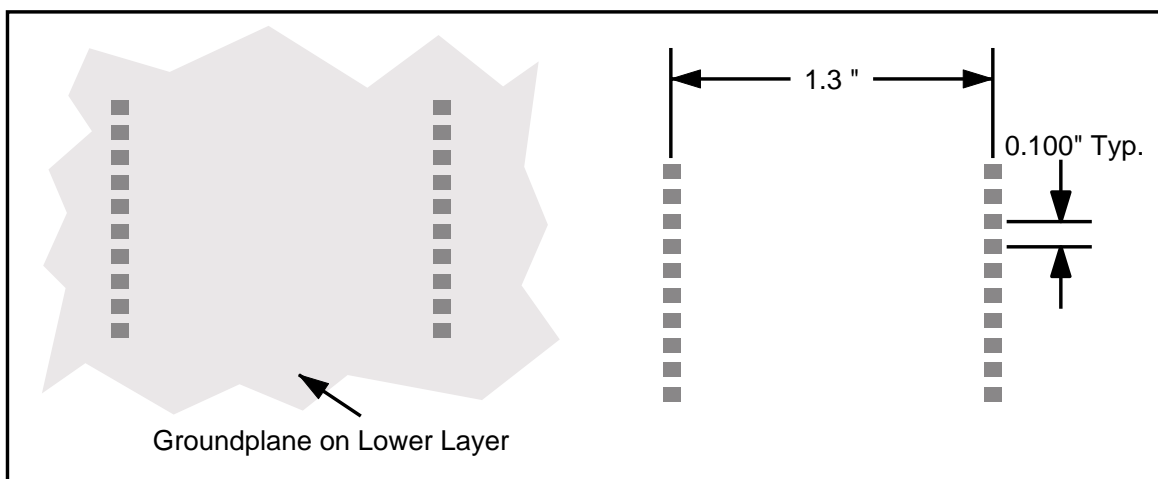
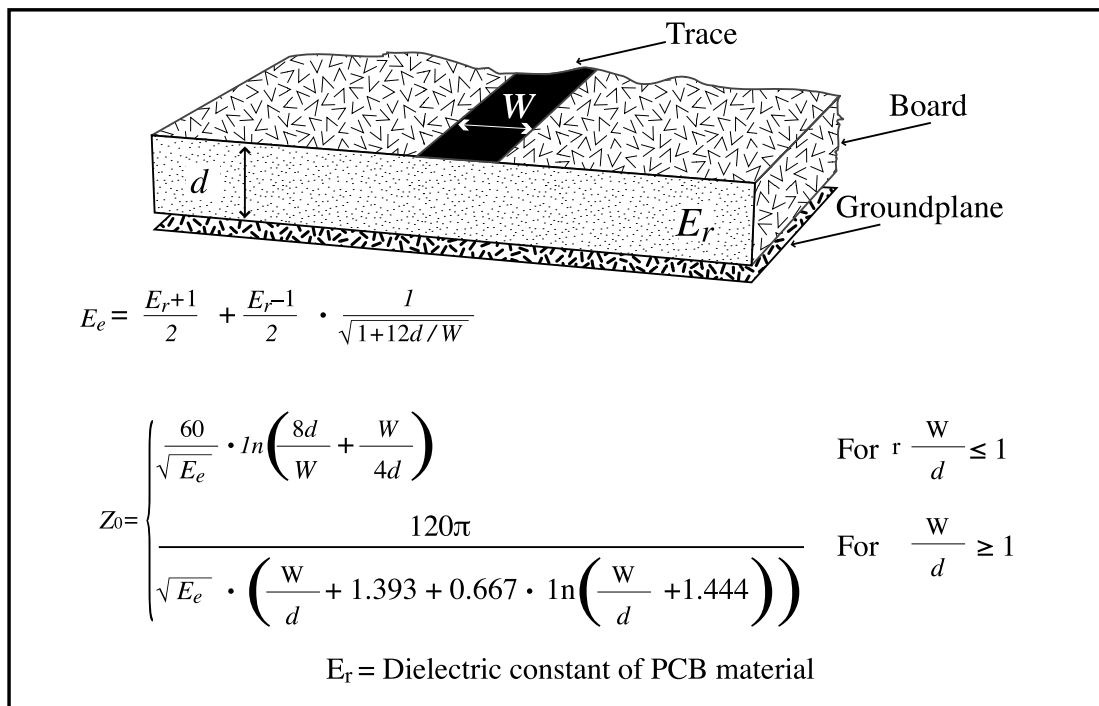

Figure 9: Recommended PCB layout

MICROSTRIP DETAILS

A transmission line is a medium whereby RF energy is transferred from one place to another with minimal loss. This is a critical factor, particularly in high-frequency products like the SC-S, because the trace leading to the module's antenna can effectively contribute to the length of the antenna, changing its resonant bandwidth. In order to minimize loss and detuning, some form of transmission line between the antenna and the module is needed, unless the antenna connection can be made in close proximity: <1/8 in. to the module. One common form of transmission line is coax cable, another is the *microstrip*. This term refers to a PCB trace running over a groundplane which is designed to serve as a transmission line between the module and the antenna. The width is based on the desired characteristic impedance, the thickness of the PCB, and its dielectric constant. For standard .062 thick FR-4 material, the trace width would be .111mils. The correct trace width can be calculated for other widths and materials using the information below.



Dielectric Constant	Width/Height (W/d)	Effective Dielectric Constant	Characteristic Impedance
4.8	1.8	3.59	50.0
4	2	3.07	51.0
2.55	3	2.12	48.0

Figure 10: Microstrip formulas ($E_r = \text{Dielectric constant of pc board material}$)

ANTENNA CONSIDERATIONS

The choice of antennas is one of the most critical and often overlooked design considerations. The range, performance, and legality of an RF link is critically dependent upon the type of antenna employed. Proper design and matching of an antenna is a complex task requiring sophisticated test equipment and a strong background in the principles of RF propagation. While adequate antenna performance can often be obtained by trial and error methods, you may also want to consider utilizing a premade antenna from Linx. Our low-cost antenna line is designed to ensure maximum performance and Part 15 compliance. The purpose of the following sections is to give you a basic idea of some of the considerations involved in the design and selection of antennas. For a more comprehensive discussion please review Linx applications note #00500 "Antennas: Design, Application, Performance".

GENERAL ANTENNA RULES

An antenna allows RF energy to be efficiently conveyed to and from free space. The antenna should give its optimum performance in the band of use and capture as little as possible of other off-frequency signals. It is important to recognize that the antenna plays a significant role in determining the performance and legality of your end product. In order to gain a better understanding of the considerations involved in the design and selection of antennas, please review Linx applications note #00500 "Antennas: Design, Application, Performance".

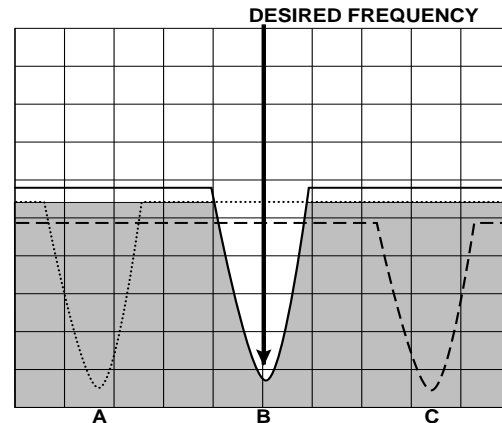

Figure 11

It is usually best to utilize a basic quarter-wave whip for your initial concept evaluation. Once your product is operating satisfactorily, a production antenna should be selected to meet the cost, size and cosmetic requirements of the product.

Maximum antenna efficiency is always obtained when the antenna is at resonance. If the antenna is too short, capacitive reactance is present; if it is too long, inductive reactance will be present. The indicator of resonance is the minimum point in the VSWR curve. You will see from the adjoining example that antenna (A) is resonant at too low a frequency, indicating excessive length, while antenna (C) is resonant at too high a frequency, indicating the antenna is too short. Antenna (B), however, is "just right."

Antenna resonance should not be confused with antenna impedance. The difference between resonance and impedance is most easily understood by considering the value of VSWR at its lowest point. The lowest point of VSWR indicates the antenna is resonant, but the value of that low point is determined by the quality of the match between the antenna, the transmission line, and the device to which it is attached.

To fully appreciate the importance of an antenna that is both resonant and matched consider that an antenna with a VSWR of 1.5 will effectively transmit approximately 95% of its power while an antenna with a VSWR of 10 will only transmit about 30%.

GUIDELINES FOR OPTIMUM ANTENNA PERFORMANCE

1. Proximity to objects such as a user's hand or body, or metal objects will cause an antenna to detune. For this reason the antenna shaft and tip should be positioned as far away from such objects as possible.
2. Optimum performance will be obtained from a 1/4- or 1/2-wave straight whip mounted at a right angle to the groundplane. In many cases this isn't desirable for practical or ergonomic reasons; thus, an alternative antenna style such as a helical, loop, patch, or base-loaded whip may be utilized.
3. If an internal antenna is to be used, keep it away from other metal components, particularly large items like transformers, batteries, and PCB tracks and groundplanes. In many cases, the space around the antenna is as important as the antenna itself.

4. In many antenna designs, particularly 1/4-wave whips, the groundplane acts as a counterpoise, forming, in essence, a 1/2-wave dipole. For this reason adequate groundplane area is essential. The groundplane can be a metal case or ground-fill areas on a circuit board. Ideally, the groundplane

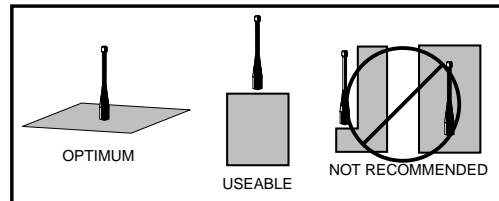

figure 12: Groundplane Orientation

to be used as counterpoise should have a surface area \geq the overall length of the 1/4-wave radiating element; however, Linx recognizes that this is impossible for most compact designs, so all Linx antennas are characterized using a 4.5" X 4.5" groundplane with the antenna centered and oriented at a 90° angle. Such an orientation is often not practical due to size and configuration constraints. In these instances a designer must make the best use of the area available to create as much groundplane in proximity to the base of the antenna as possible. In instances where the antenna is remotely located or the antenna is not in close proximity to a circuit board plane or grounded metal case, a small metal plate may be fabricated to maximize antenna performance.

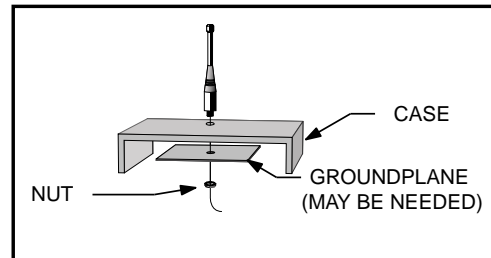

figure 13: Remote Groundplane

5. Remove the antenna as far as possible from potential interference sources. There are many possible sources of internally generated interference. Switching power supplies, oscillators, even relays can also be significant sources of potential interference. Remember, the single best weapon against such problems is attention to placement and layout. Filter the module's power supply with a high-frequency bypass capacitor. Place adequate groundplane under all potential sources of noise. Shield noisy board areas whenever practical.
6. In some applications it is advantageous to place the transceiver and its antenna away from the main equipment. This avoids interference problems and allows the antenna to be oriented for optimum RF performance. Always use 50Ω coax such as RG-174 for the remote feed.

COMMON ANTENNA STYLES

There are literally hundreds of antenna styles that can be successfully employed with the SC Series. Following is a brief discussion of the three styles most commonly utilized in compact RF designs. Additional antenna information can be found in Linx application notes #00500, #00100, #00126 and #00140.

Whip Style

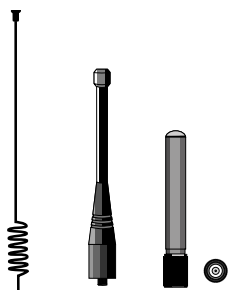

A whip-style monopole antenna provides outstanding overall performance and stability. A low-cost whip can be easily fabricated from wire or rod, but most product designers opt for the improved performance and cosmetic appeal of a professionally made model. To meet this need, Linx offers a wide variety of straight and reduced-height whip-style antennas in permanent and connectorized mounting styles.

The wavelength of the operational frequency determines an antenna's overall length. Since a full wavelength is often quite long, a partial 1/4-wave antenna is normally employed. Its size and natural radiation resistance make it well matched to Linx modules. The proper length for a 1/4-wave antenna can be easily found using the formula below. It is also possible to reduce the overall height of the antenna by using a helical winding. This decreases the antenna's bandwidth but is an excellent way to minimize the antenna's physical size for compact applications.

1/4-wave wire lengths for SC-S frequencies:

433MHz = 6.5"

868MHz = 3.24"

902-928MHz = 3.06"

$$L = \frac{234}{F_{\text{MHz}}}$$

Where:

L = length in feet of quarter-wavelength
F = operating frequency in megahertz

Example:

$$\frac{234}{916\text{MHz}} = .255$$

$$.255 \times 12 = 3.06"$$

Helical Style



A helical antenna is precisely formed from wire or rod. A helical antenna is a good choice for low-cost products requiring average range performance and internal concealment. A helical can detune badly in proximity to other objects and its bandwidth is quite narrow so care must be exercised in layout and placement.

Loop Style

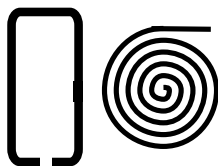

A loop- or trace-style antenna is normally printed directly on a product's PCB. This makes it the most cost-effective of antenna styles. There are a variety of shapes and layout styles which can be utilized. The element can be made self-resonant or externally resonated with discrete components. Despite its cost advantages, PCB antenna styles are generally inefficient and useful only for short-range applications. Loop-style antennas are also very sensitive to changes in layout or substrate dielectric which can introduce consistency issues into the production process. In addition, printed styles initially are difficult to engineer, requiring the use of expensive equipment including a network analyzer. An improperly designed loop will have a high SWR at the desired frequency which can introduce substantial instability in the RF stages.

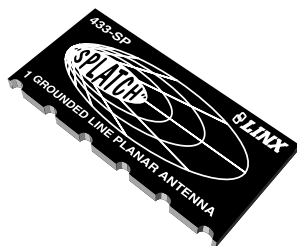

Linx offers a low-cost planar antenna called the "SPLATCH" which is an excellent alternative to the sometimes problematic PCB trace style. This tiny antenna mounts directly to a product's PCB and requires no testing or tuning. Its design is stable even in compact applications and it provides excellent performance in light of its compact size.

PRODUCTION GUIDELINES

The SC-S modules are packaged in a hybrid SMD package which has been designed to support hand- or automated-assembly techniques. Since SC-S devices contain discrete components internally, the assembly procedures are critical to insuring the reliable function of the SC-S product. The following procedures should be reviewed with and practiced by all assembly personnel.

TRANSCEIVER HAND ASSEMBLY

The SC-S Transceiver's primary mounting surface is twenty pads located on the bottom of the module. Since these pads are inaccessible during mounting, castellations that run up the side of the module have been provided to facilitate solder wicking to the module's underside. If the recommended pad placement has been followed, the pad on the board will extend slightly past the edge of the module. Touch both the PCB pad and the module castellation with a fine soldering tip. Tack one module corner first, then work around the remaining attachment points using care not to exceed the solder times listed below.

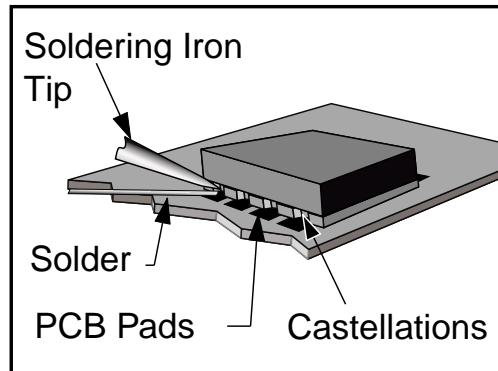

Figure 14: Soldering Technique

Note:

Care should be taken, especially when hand-soldering, not to use excessive amounts of flux as it will wick under the module and potentially cause irregularity in its function. In most cases, no-clean solder is the best choice.

Absolute Maximum Solder Times

Hand-Solder Temp. TX +225°C for 10 Sec.

Hand-Solder Temp. RX +225°C for 10 Sec.

Recommended Solder Melting Point +180°C

Reflow Oven: +220° Max. (See adjoining diagram)

TRANSCEIVER AUTOMATED ASSEMBLY

For high-volume assembly most users will want to auto-place the modules. The modules have been designed to maintain compatibility with most pick-and-place equipment; however, due to the module's hybrid nature certain aspects of the automated assembly process are far more critical than for other component types. Process compatibility is the customer's responsibility. Small trial production runs should be made to verify yields prior to volume production.

Following are brief discussions of the three primary areas where caution must be observed.

Reflow Temperature Profile

The single most critical stage in the automated assembly process is the reflow process. The reflow profile below should be closely followed since excessive temperatures or transport times during reflow will irreparably damage the modules. Assembly personnel will need to pay careful attention to the oven's profile to insure that it meets the requirements necessary to successfully reflow all components while still meeting the limits mandated by the modules themselves.

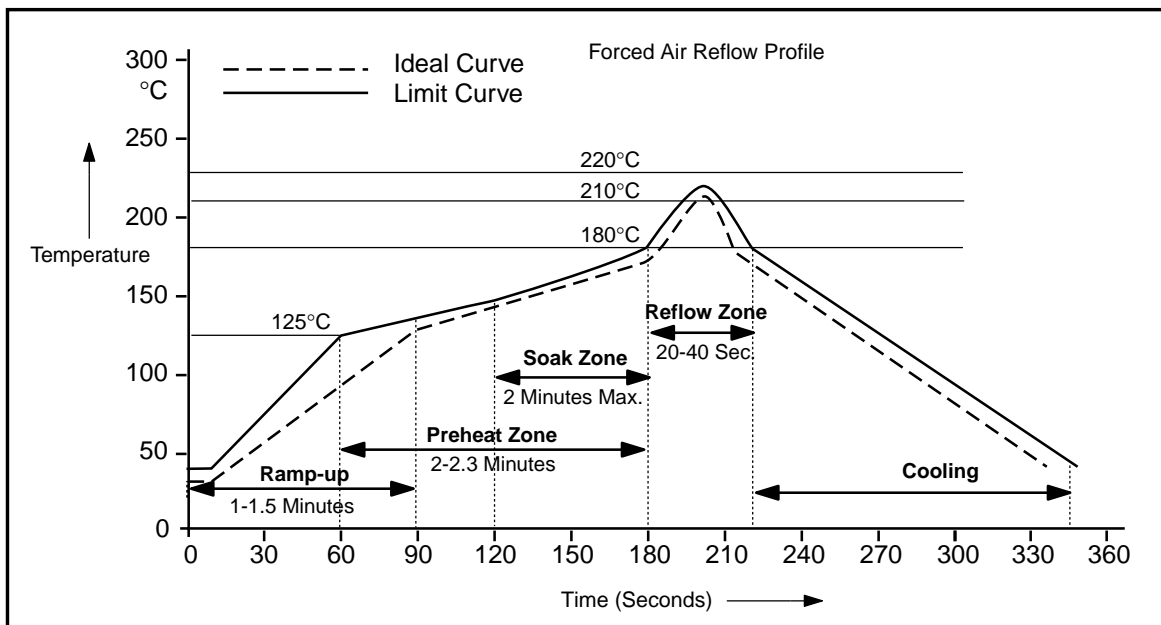

figure 15: Maximum reflow profile

Shock During Reflow Transport

Since some internal module components may reflow along with the components placed on the board being assembled, it is imperative that the module not be subjected to shock or vibration during the time solder is liquidus.

Washability

The modules are wash resistant, but are not hermetically sealed. They may be subject to a standard wash cycle; however, a twenty-four-hour drying time should be allowed before applying electrical power to the modules. This will allow any moisture that has migrated into the module to evaporate, thus eliminating the potential for shorting during power-up or testing.

LEGAL CONSIDERATIONS

NOTE: SC-Series Modules are designed as component devices which require external components to function. The modules are intended to allow for full Part 15 compliance; however, they are not approved by the FCC or any other agency worldwide. The purchaser understands that approvals may be required prior to the sale or operation of the device, and agrees to utilize the component in keeping with all laws governing its operation in the country of operation.

When working with RF, a clear distinction must be made between what is technically possible and what is legally acceptable in the country where operation is intended. Many manufacturers have avoided incorporating RF into their products as a result of uncertainty and even fear of the approval and certification process. Here at Linx our desire is not only to expedite the design process, but also to assist you in achieving a clear idea of what is involved in obtaining the approvals necessary to legally market your completed product.

In the United States the approval process is actually quite straightforward. The regulations governing RF devices and the enforcement of them are the responsibility of the Federal Communications Commission. The regulations are contained in the Code of Federal Regulations (CFR), Title 47. Title 47 is made up of numerous volumes; however, all regulations applicable to this module are contained in volume 0-19. It is strongly recommended that a copy be obtained from the Government Printing Office in Washington, or from your local government book store. Excerpts of applicable sections are included with Linx evaluation kits or may be obtained from the Linx Technologies web site (www.linxtechnologies.com). In brief, these rules require that any device which intentionally radiates RF energy be approved, that is, tested, for compliance and issued a unique identification number. This is a relatively painless process. Linx offers full EMC pre-compliance testing in our HP/Emco-equipped test center. Final compliance testing is then performed by one of the many independent testing laboratories across the country. Many labs can also provide other certifications the product may require at the same time, such as UL, CLASS A/B, etc. Once your completed product has passed, you will be issued an ID number which is then clearly placed on each product manufactured.

Questions regarding interpretations of the Part 2 and Part 15 rules or measurement procedures used to test intentional radiators should be addressed to:

Federal Communications Commission
Equipment Authorization Division
Customer Service Branch, MS 1300F2
7435 Oakland Mills Road
Columbia, MD 21046

Tel: (301) 725-1585 / Fax: (301) 344-2050 E-Mail: labinfo@fcc.gov

International approvals are slightly more complex, although many modules are designed to allow all international standards to be met. If you are considering the export of your product abroad, you should contact Linx Technologies to determine the specific suitability of the module to your application.

All Linx modules are designed with the approval process in mind and thus much of the frustration that is typically experienced with a discrete design is eliminated. Approval is still dependent on many factors such as the choice of antennas, correct use of the frequency selected, and physical packaging. While some extra cost and design effort are required to address these issues, the additional usefulness and profitability added to a product by RF makes the effort more than worthwhile.

ACHIEVING A SUCCESSFUL RF IMPLEMENTATION

Adding wireless capabilities brings an exciting new dimension to any product. It also means that additional effort and commitment will be needed to bring the product successfully to market. By utilizing Linx RF modules the design and approval process will be greatly simplified. It is important, however, to have an objective view of the steps necessary to insure a successful RF integration. Since the capabilities of each customer vary widely it is difficult to recommend one particular design path, but most projects follow steps similar to those shown at the right.

In reviewing this sample design path you may notice that Linx offers a variety of services, such as antenna design, and FCC prequalification, that are unusual for a high-volume component manufacturer. These services, along with an exceptional level of technical support, are offered because we recognize that RF is a complex science requiring the highest caliber of products and support. "Wireless Made Simple" is more than just a motto, it's our commitment. By choosing Linx as your RF partner and taking advantage of the resources we offer, you will not only survive implementing RF, but you may even find the process enjoyable.

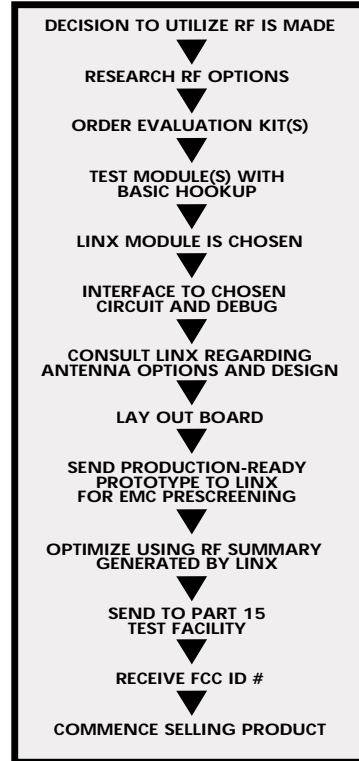

TYPICAL STEPS FOR IMPLEMENTING RF

HELPFUL APPLICATION NOTES FROM LINX

It is not the intention of this manual to address in depth many of the issues that should be considered to ensure that the modules function correctly and deliver the maximum possible performance. As you proceed with your design you may wish to obtain one or more of the following application notes, which address in depth key areas of RF design and application of Linx products.

NOTE #	LINX APPLICATION NOTE TITLE
00500	Antennas: Design, Application, Performance
00130	Modulation techniques for low-cost RF data links
00126	Considerations for operation in the 902 Mhz to 928 Mhz band
00100	RF 101: Information for the RF challenged
00140	The FCC Road: Part 15 from concept to approval
00150	Use and design of T-Attenuation Pads
00102	RS-232 A brief overview



U.S. CORPORATE HEADQUARTERS:

LINX TECHNOLOGIES, INC.

575 S.E. ASHLEY PLACE
GRANTS PASS, OR 97526

Phone: (541) 471-6256

FAX: (541) 471-6251

<http://www.linxtechnologies.com>

Disclaimer

Linx Technologies is continually striving to improve the quality and function of its products; for this reason, we reserve the right to make changes without notice. The information contained in this Data Sheet is believed to be accurate as of the time of publication. Specifications are based on representative lot samples. Values may vary from lot to lot and are not guaranteed. Linx Technologies makes no guarantee, warranty, or representation regarding the suitability of any product for use in a specific application. None of these devices is intended for use in applications of a critical nature where the safety of life or property is at risk. The user assumes full liability for the use of product in such applications. Under no conditions will Linx Technologies be responsible for losses arising from the use or failure of the device in any application, other than the repair, replacement, or refund limited to the original product purchase price. Some devices described in this publication are patented. Under no circumstances shall any user be conveyed any license or right to the use or ownership of these patents.

© 2001 by Linx Technologies, Inc. The stylized Linx logo, Linx, and "Wireless made Simple" are the trademarks of Linx Technologies, Inc.
Printed in U.S.A.