

Plug : TM31P-TM-88P

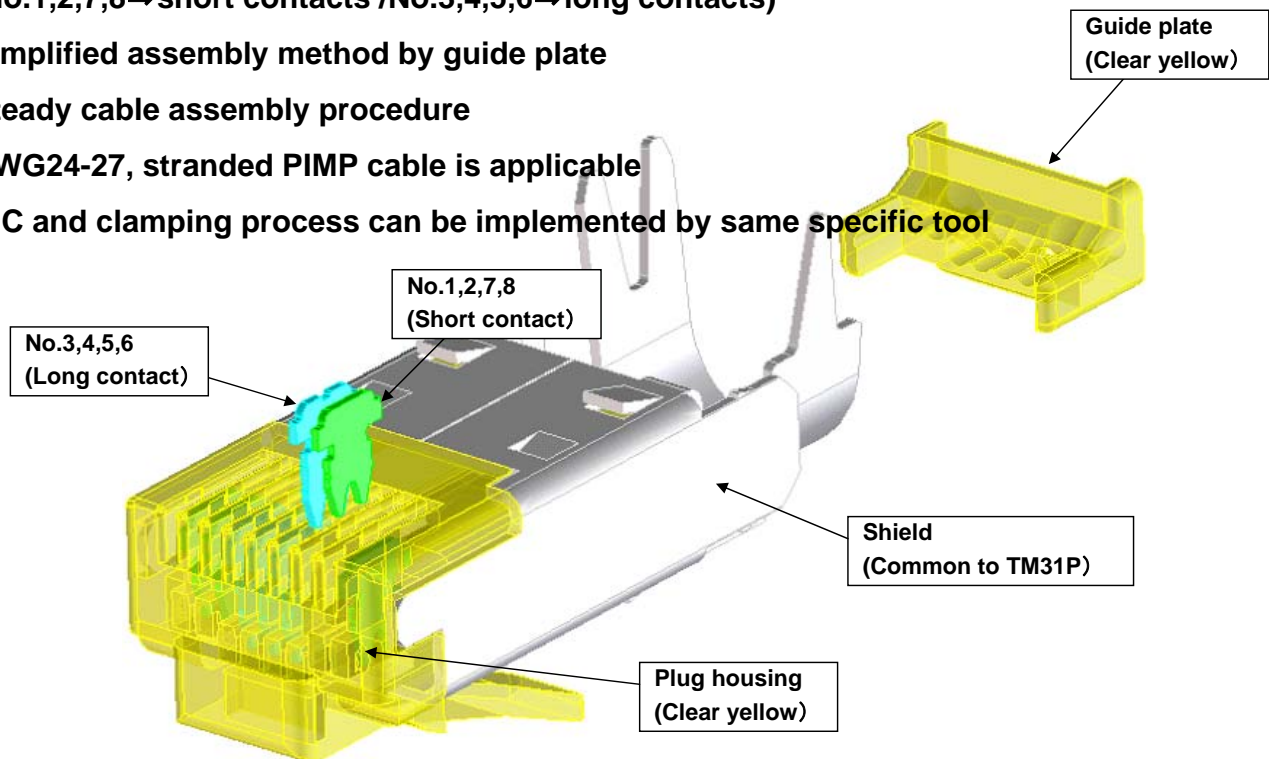

1. Plug design satisfying CAT6a performance
(No.1,2,7,8⇒short contacts /No.3,4,5,6⇒long contacts)
2. Simplified assembly method by guide plate
3. Steady cable assembly procedure
4. AWG24-27, stranded PIMP cable is applicable
5. IDC and clamping process can be implemented by same specific tool



Copyright© 2007, HIROSE ELECTRIC CO.,LTD.

Plug : TM31P-TM-88P



Plug design satisfying CAT6a requirements

1) Unique contact arrangement

CAT6 Plug (TM21DP-TM-88P)

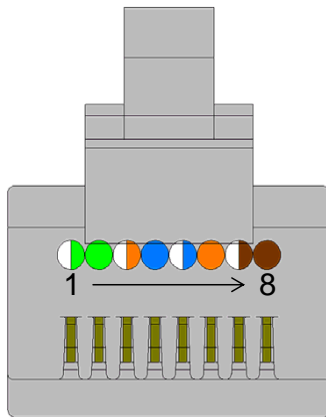

Limited performance due to the contact arrangement in a single row

Improved Transmission Characteristics

CAT6a Plug (TM31P-TM-88P)

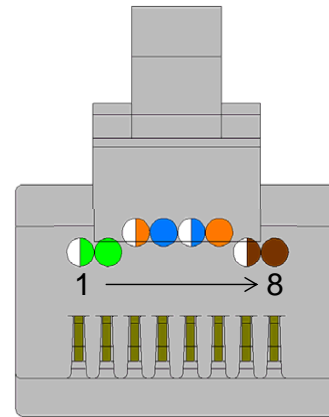

The contact arrangement in two rows makes performance improved (No3, 4, 5, 6 contacts are isolated from No1, 2, 7, 8 contacts)

Copyright © 2007, HIROSE ELECTRIC CO.,LTD.

Plug : TM31P-TM-88P



Cable assembly method to have CAT6a performance

Plug design makes it possible for users to lengthen jacket end and have steady CAT6a performance.

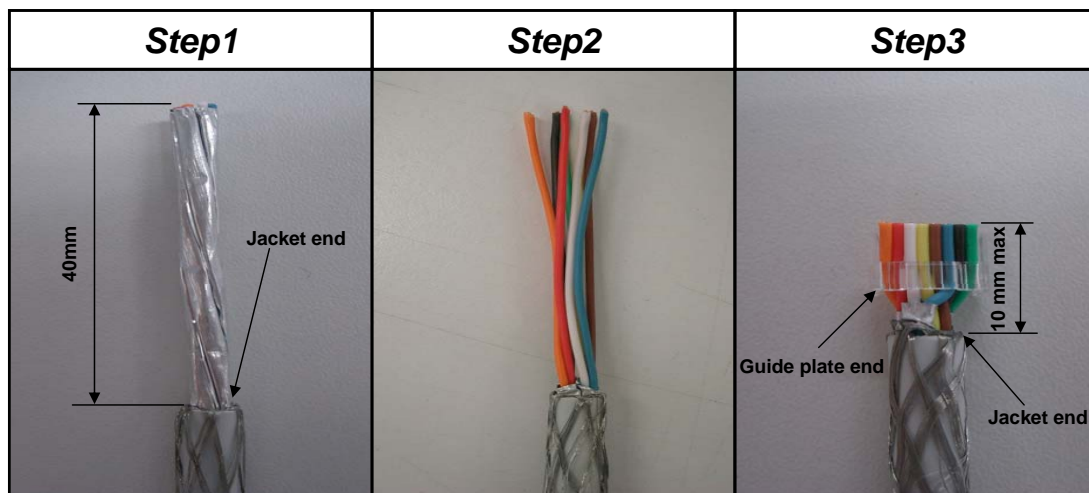

Copyright© 2007, HIROSE ELECTRIC CO.,LTD.

Plug : TM31P-TM-88P



Cable assembly method to have CAT6a performance

Plug design makes it possible for users to lengthen jacket end and have steady CAT6a performance.

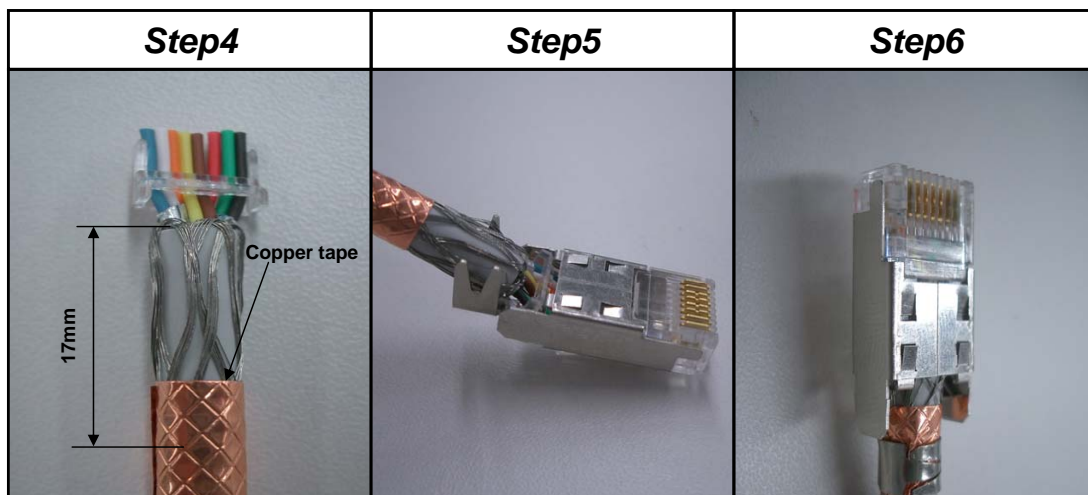

Copyright© 2007, HIROSE ELECTRIC CO.,LTD.

Plug : TM31P-TM-88P

HRS

Outer Appearance of TM31P-TM-88P with cover

TM31P-TM-88P can be assembled with TM21 covers.

Our CAT6A modular plug is consist of just 3 parts.

1. Plug Body (TM31P-TM-88P)
2. Guide Plate (TM31P Guide Plate)
3. Cover (TM21 Cover)

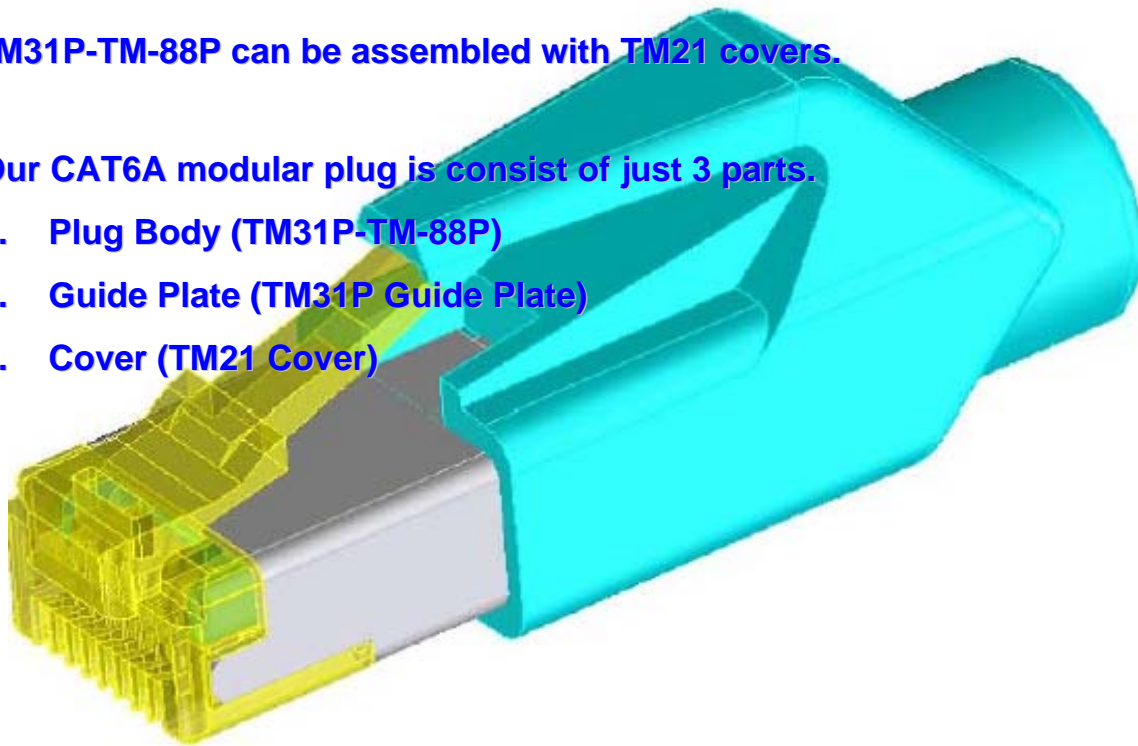

Copyright© 2007, HIROSE ELECTRIC CO.,LTD.

Plug : TM31P-TM-88P

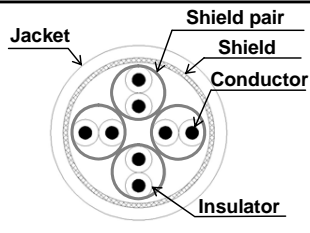

Applicable Cable

	PIMF cable	
	Conductor	AWG 24 stranded wire
		AWG 27 stranded wire
	O/D of Insulator	ϕ 0.9 to ϕ 1.0
O/D of Jacket	ϕ 5.8 to ϕ 6.0	

Cable Assembly Tool

Cable Assembly Tool of TM21DP-TM-88P
can be also used for TM31P-TM-88P



Copyright © 2007, HIROSE ELECTRIC CO.,LTD.

Plug : TM31P-TM-88P



CAT6a Performance Measurement : Plug single TM31P Model sample

Measurement Method : Direct Probe Method
Measurement Equipment : Network Analyzer
(Agilent E8357A)

Frequency : 10~500MHz

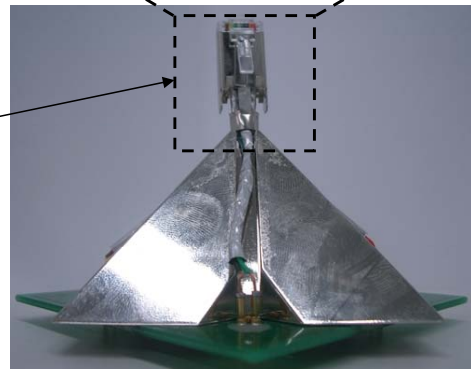
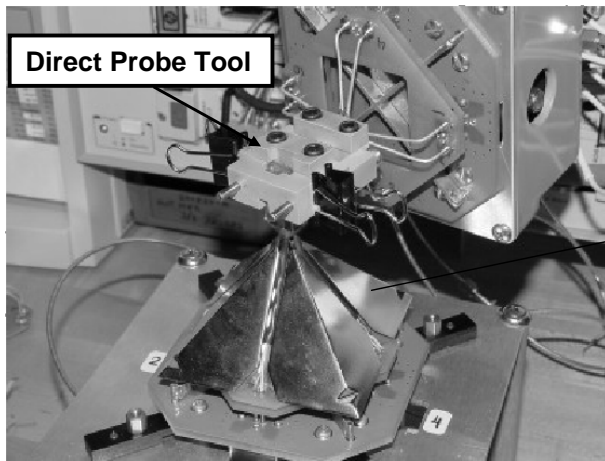

Copyright© 2007, HIROSE ELECTRIC CO.,LTD.

Plug : TM31P-TM-88P



NEXT36-45

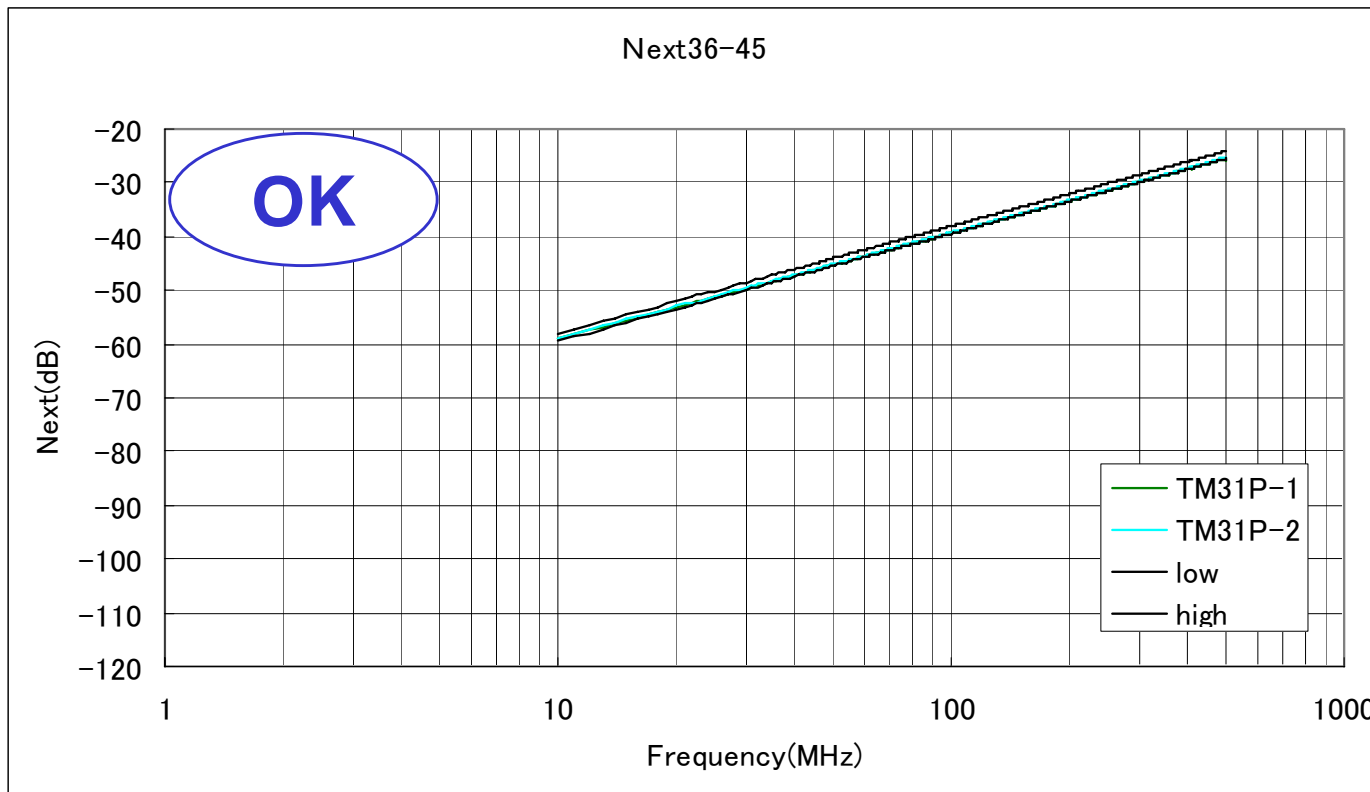

Copyright © 2007, HIROSE ELECTRIC CO.,LTD.

Plug : TM31P-TM-88P



NEXT12-36

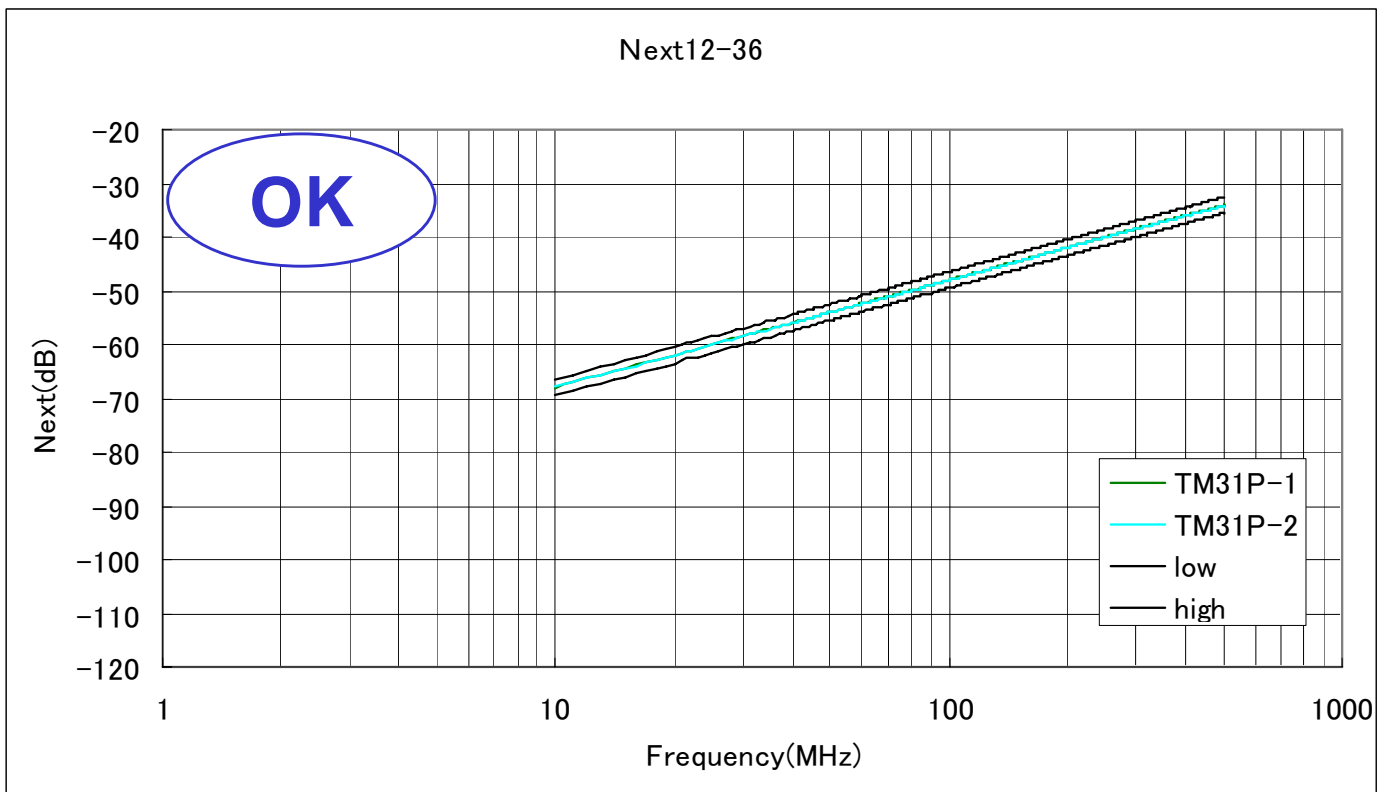

Copyright © 2007, HIROSE ELECTRIC CO.,LTD.

Plug : TM31P-TM-88P



NEXT36-78

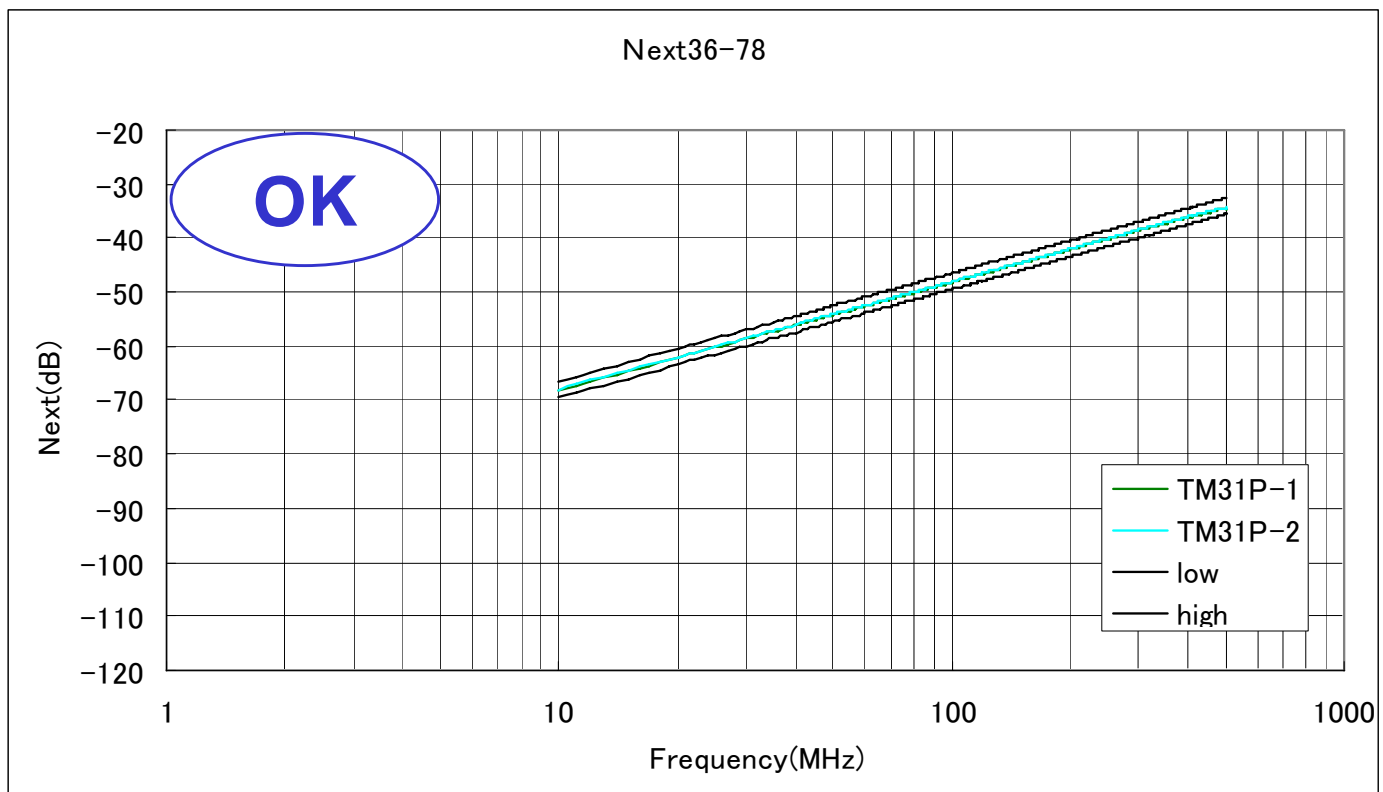

Copyright © 2007, HIROSE ELECTRIC CO.,LTD.

Plug : TM31P-TM-88P



NEXT12-45

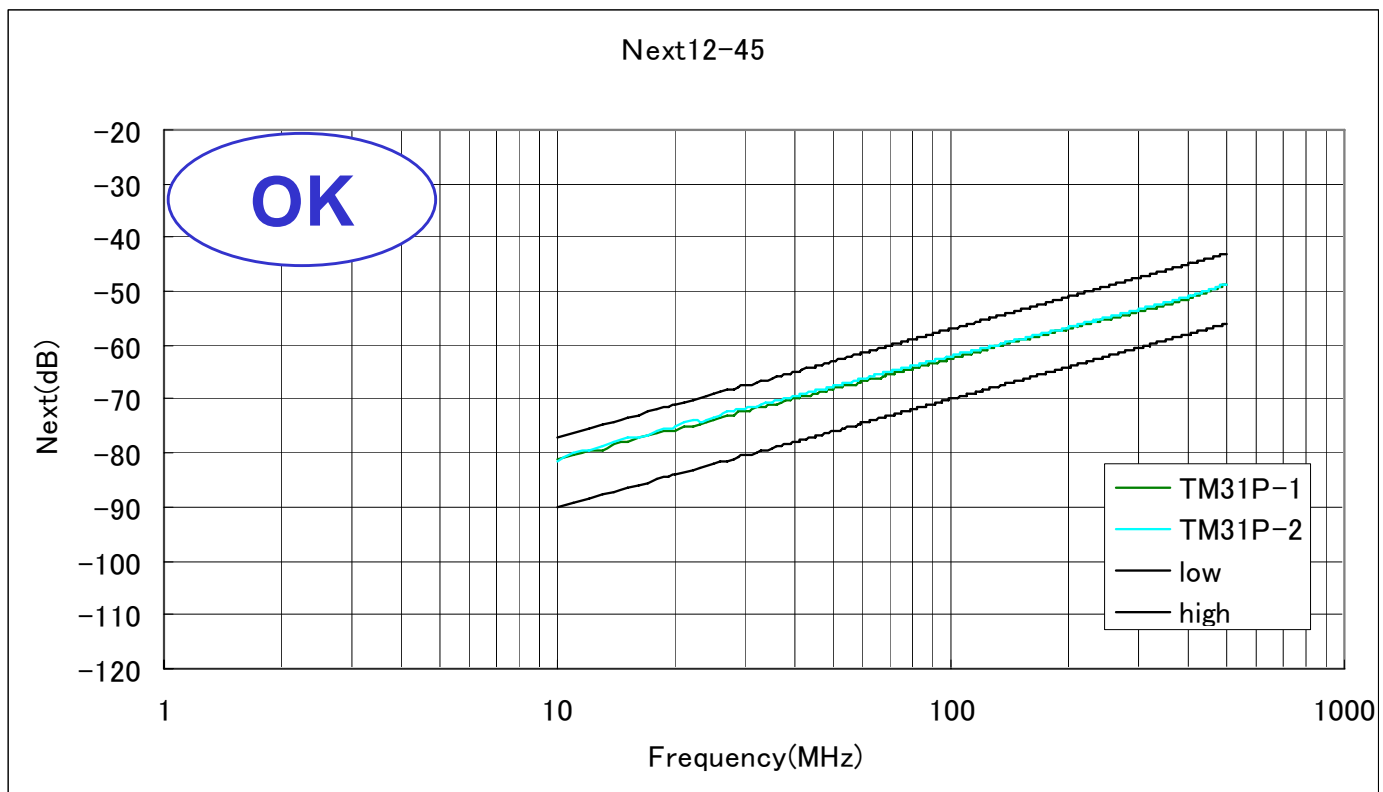

Copyright © 2007, HIROSE ELECTRIC CO.,LTD.

Plug : TM31P-TM-88P



NEXT45-78

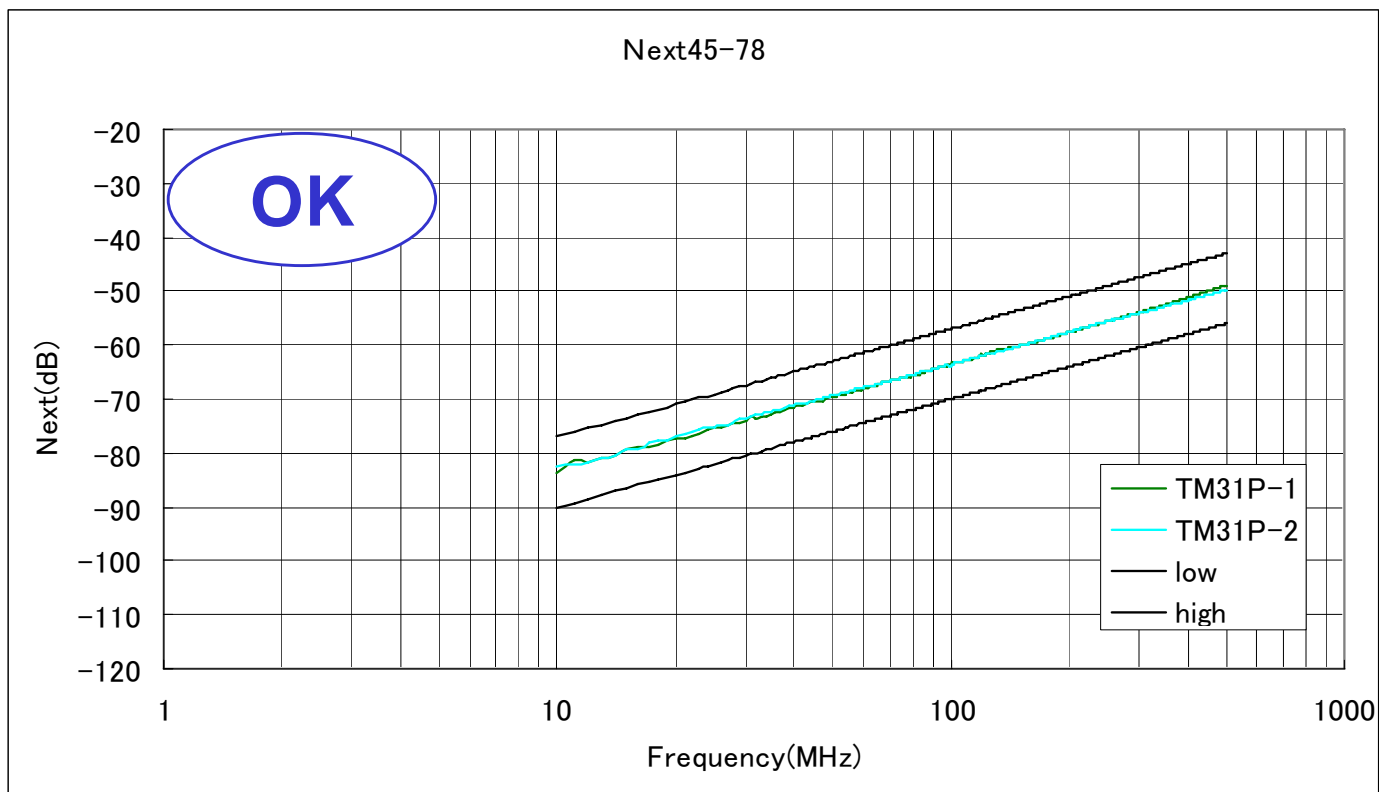

Copyright © 2007, HIROSE ELECTRIC CO.,LTD.

Plug : TM31P-TM-88P



NEXT12-78

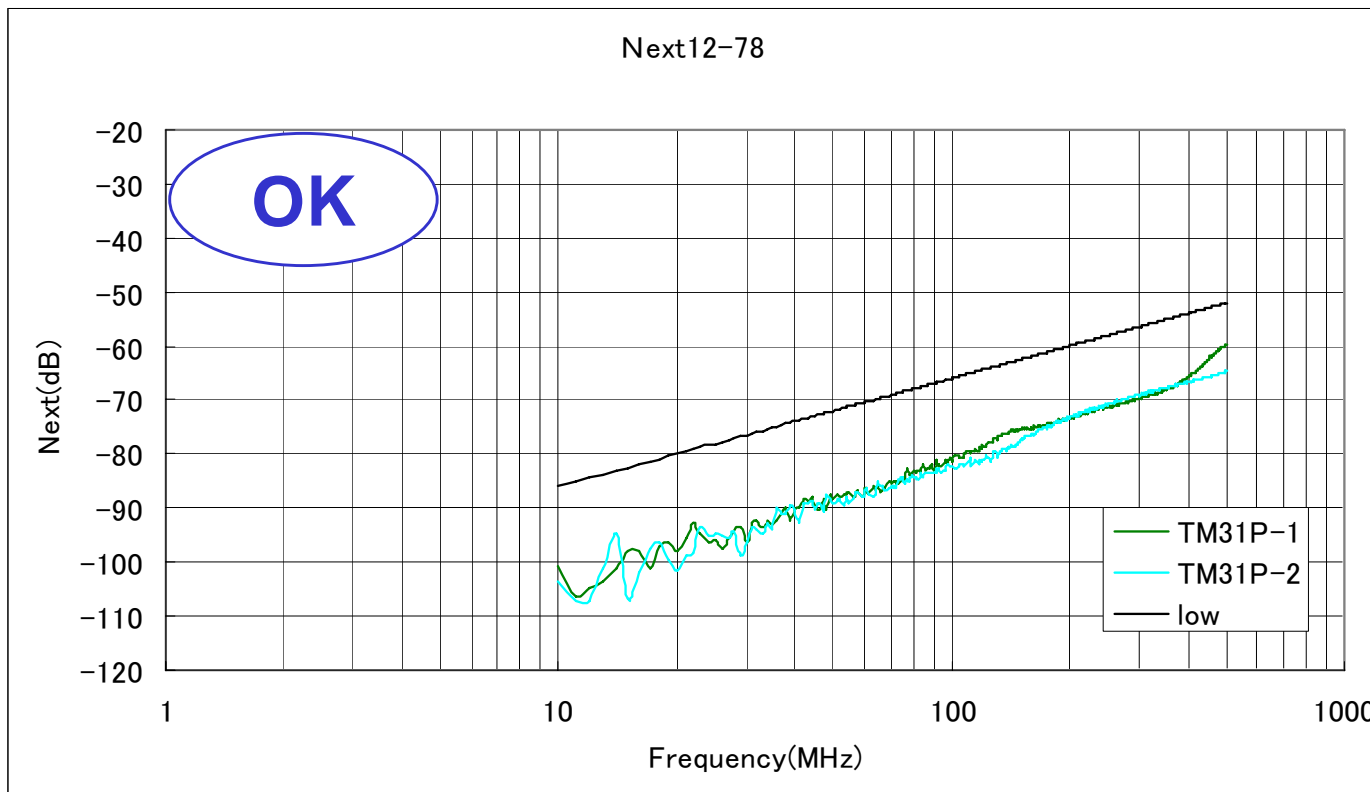

Copyright © 2007, HIROSE ELECTRIC CO.,LTD.