

Power Panel Potentiometer

FEATURES

- High power rating (6 W at 50 °C)
- Cermet element
- Full sealing
- Mechanical strength
- Industrial and professional grade
- Tests according to CECC 41 000



DIMENSIONS in millimeters

PE 60 L

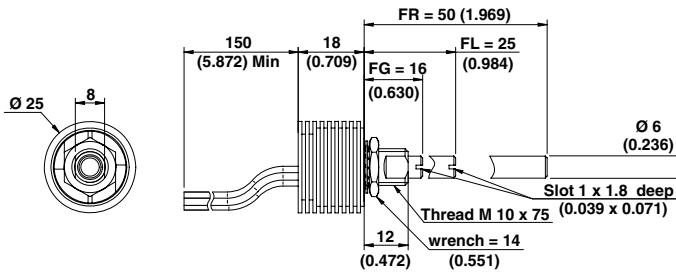

PE 60 F

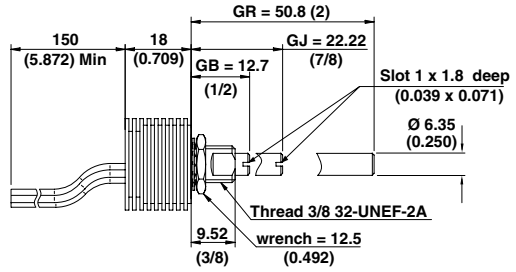

OPTION D: DBAN SHAFT LOCKING

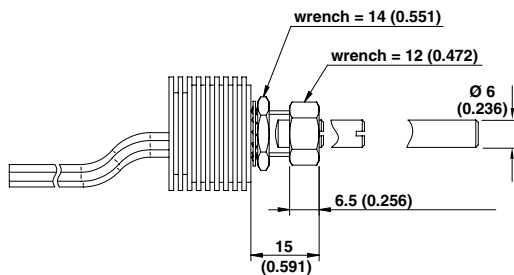

Available only with PE 60 L

OPTION L: PE 60 LPRP - WITH LOCATING PEG

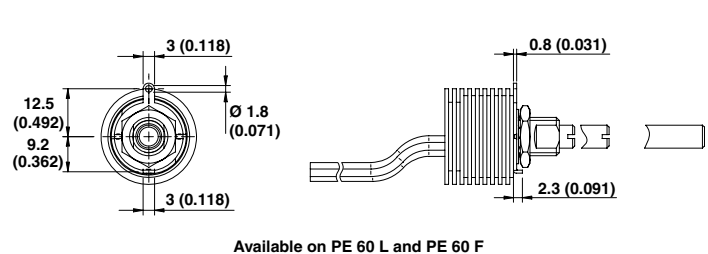

Available on PE 60 L and PE 60 F

Panel sealed version

PE 60 M

OPTION E: Including locating peg (available only for PE 60 M)

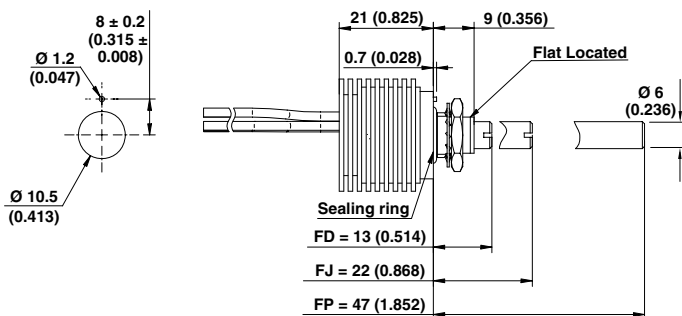

Available only with bushing M10 x 0.75 and shafts Ø 6 mm

CIRCUIT DIAGRAM

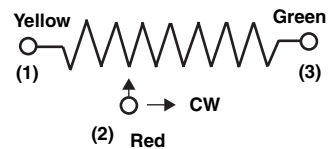

**SPECIAL FEATURES
COMMAND SHAFT**

Length is measured from the mounting surface to the free end of the shaft. The screwdriver slot is aligned with the wiper within $\pm 10^\circ$. Special shafts are available, in accordance to drawings supplied by customers. We recommend that customers should not machine shafts, in order to avoid damage.

PANEL SEALING: PE60M

The panel sealing device consists of a ring located in a slot on the potentiometer face. Sealing is obtained by tightening the ring against the panel when mounting the potentiometer.

SHAFT LOCKING: DBAN

The shaft locking device consists of a tapered nut tightening a slotted notched washer against both bushing and shaft. DBAN tightening torque is 200 Ncm, shaft locking torque being 30 Ncm.

DBAN is also available with all special types.

This device is normally supplied in a separate bag. Can be pre-mounted on request.

LOCATING PEG: LPRP

Location is obtained by fitting a special washer on the potentiometer face. The peg can therefore be positioned at 90° , 180° , 270° and 360° .

ELECTRICAL SPECIFICATIONS		
Resistive Element		cermet
Electrical Travel		$270^\circ \pm 10^\circ$
Resistance Range	Linear Law	1Ω to $1 \text{ M}\Omega$
	Logarithmic Laws	100Ω to $2.2 \text{ M}\Omega$
Standard series E3		1 - 2 - 2.5 - 5
Tolerance	Standard	$\pm 20 \%$
	On Request	$\pm 10 \%$ - $\pm 5 \%$
Power Rating	Linear	6 W at $+ 50^\circ \text{C}$
	Logarithmic	3 W at $+ 50^\circ \text{C}$
Temperature Coefficient		see Standard Resistance Element Data
Limiting Element Voltage (Linear Law)		350 V
Contact Resistance Variation (Linear Law)		3 % R_n or 0.5Ω
End Resistance (Typical)		0.5Ω or 1 %
Dielectric Strength (RMS)		2500 V
Insulation Resistance (500 VDC)		$10^6 \text{ M}\Omega$

MECHANICAL SPECIFICATIONS

Mechanical Travel	$300^\circ \pm 5^\circ$
Operating Torque (max. Ncm)	3 typical
End Stop Torque (max. Ncm)	70
Max Tightening Torque of Mounting Nut (Ncm)	250
Unit Weight (max. g)	25 to 35

ENVIRONMENTAL SPECIFICATIONS

Temperature Range	$- 55^\circ \text{C}$ to $+ 125^\circ \text{C}$
Climatic Category	55/125/56
Sealing	fully sealed container IP67

POWER RATING CHART

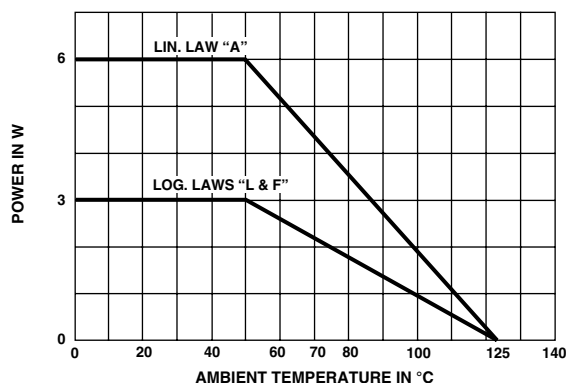

RESISTANCE LAWS

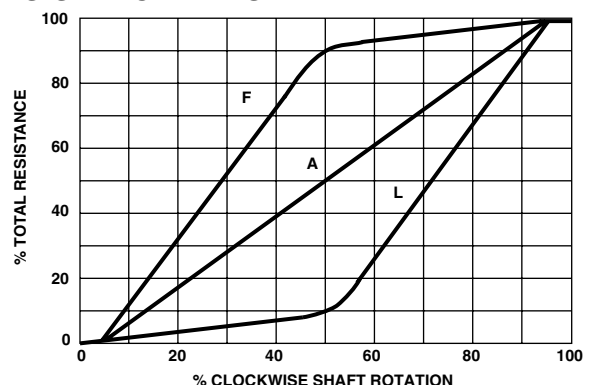



PERFORMANCE			
TESTS	CONDITIONS	TYPICAL VALUES AND DRIFTS	
		$\frac{\Delta RT}{RT}$ (%)	$\frac{\Delta R_{1-2}}{R_{1-2}}$ (%)
Climatic Sequence	Phase A dry heat 125 °C Phase B damp heat Phase C cold - 55 °C Phase D damp heat 5 cycles	± 0.5 %	± 1 %
Long Term Damp Heat	56 days	± 0.5 % Insulation resistance: > 10 ⁴ MΩ	± 1 %
Rotational Life	25 000 cycles	± 3 % Contact res. variation: < 5 % R _n	
Load Life	1000 hours at rated power 90°/30' - ambient temp. 25 °C	± 3 % Contact res. variation: < 3 % R _n	
Rapid Temperature Change	5 cycles - 55 °C at + 125 °C	± (0.5 % ± 0.1 %)	
Shock	50 g at 11 ms 3 successive shocks in 3 directions	± 0.1 %	± 0.2 %
Vibration	10 - 55 Hz 0.75 mm or 10 g during 6 hours	± 0.1 %	± 0.2 %

STANDARD RESISTANCE ELEMENT DATA				
STANDARD RESISTANCE VALUES	LINEAR LAW			TYPICAL TCR - 55 °C + 125 °C
	MAX. POWER AT 25 °C	MAX. WORKING VOLTAGE	MAX. CUR. THROUGH WIPER	
Ω	W	V	mA	ppm/°C
1	6	2.4	2449	± 500
2	↓	3.5	1732	
5		5.5	1095	
10		7.7	775	
20		11.0	548	
25		12.2	490	
50		↓	17.3	
100	24.5		245	
200	34.6		173.2	
250	38.7		154.9	
500	54.8		109.5	
1K	77.5		77.5	
2K	110		54.8	
2.5K	122		49.0	
5K	173		34.64	
10K	245		24.49	
20K	6	346	17.32	
25K	4.90	350	14.00	
50K	2.45	↓	7.00	
100K	1.23		3.50	
200K	0.61		1.75	
250K	0.49		1.40	
500K	0.25		0.70	
1M	0.12	350	0.35	

MARKING

- Printed:
- VISHAY trademark
 - SAP Part number
 - manufacturing date

PACKAGING

- in box of 5 pieces



SAP ORDERING INFORMATION (Part Number 18 digits)																	
P	E	6	0	L	0	F	G	W	2	0	4	M	A				
MODEL	BUSHING	OPTION			SHAFT			LEADS	OHMIC VALUE	TOLERANCE		LAW		SPECIAL NUMBER			
	M = Panel sealed L = STD F = 3/8"	0 = none For L Bushing D = DBAN L = LPRP B = DBAN and LPRP For F Bushing L = LPRP For M Bushing E = Peg			For L Bushing FG 16 mm, slotted FL 25 mm, slotted FR 50 mm, plain For F Bushing GB 1/2", slotted GJ 7/8", slotted GR 2", slotted For M Bushing FD = 13 mm, slotted FJ = 22 mm, slotted FP = 47 mm, plain			W: Wire	204 = 200 kΩ	± 20 % on request ± 10 % ± 5 %		A = Linear L = clockwise logarithmic F = clockwise inverse logarithmic		(if applicable) Given by VISHAY for custom design			

PART NUMBER DESCRIPTION (for information only)											
PE60	L	0	FG	W	200 kΩ	20 %	A	BO5			e4
MODEL	BUSHING	OPTION	SHAFT	LEADS	OHMIC VALUE	TOL	LAW	PACKAGING	SPECIAL	SPECIAL	LEAD (Pb)-FREE



Disclaimer

All product specifications and data are subject to change without notice.

Vishay Intertechnology, Inc., its affiliates, agents, and employees, and all persons acting on its or their behalf (collectively, "Vishay"), disclaim any and all liability for any errors, inaccuracies or incompleteness contained herein or in any other disclosure relating to any product.

Vishay disclaims any and all liability arising out of the use or application of any product described herein or of any information provided herein to the maximum extent permitted by law. The product specifications do not expand or otherwise modify Vishay's terms and conditions of purchase, including but not limited to the warranty expressed therein, which apply to these products.

No license, express or implied, by estoppel or otherwise, to any intellectual property rights is granted by this document or by any conduct of Vishay.

The products shown herein are not designed for use in medical, life-saving, or life-sustaining applications unless otherwise expressly indicated. Customers using or selling Vishay products not expressly indicated for use in such applications do so entirely at their own risk and agree to fully indemnify Vishay for any damages arising or resulting from such use or sale. Please contact authorized Vishay personnel to obtain written terms and conditions regarding products designed for such applications.

Product names and markings noted herein may be trademarks of their respective owners.