

Spezifikation für Freigabe / specification for release

Kunde / customer :
 Artikelnummer / part number : **744212820**
 Bezeichnung : **STROMKOMP. SMD LINE FILTER WE-SL1**
 description : **COMMON MODE SMD LINE FILTER WE-SL1**



DATUM / DATE : 2010-11-03

A Mechanische Abmessungen / dimensions:

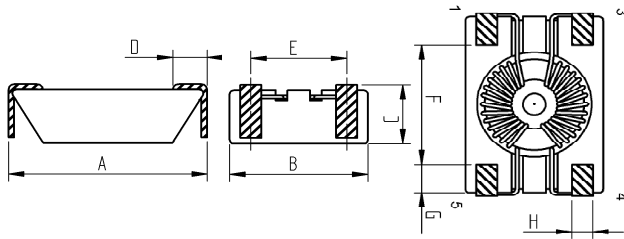

A	6,50 max.	mm
B	3,60 ± 0,15	mm
C	1,65 ± 0,15	mm
D	0,90 min.	mm
E	2,50 ± 0,15	mm
F	3,40 ± 0,20	mm
G	0,80 max.	mm
H	0,55 ± 0,10	mm

B Elektrische Eigenschaften / electrical properties:

Eigenschaften / properties	Testbedingungen / test conditions		Wert / value	Einheit / unit	tol.
Induktivität / inductance	100 mV / 100 kHz	L _{1-5;3-4}	82	μH	±50%
DC-Widerstand / DC-resistance		R _{DC}	0,20	Ω	max.
Nennstrom / rated current	ΔT= 20K	I _{DC}	300	mA	max.
Impedanz / impedance		Z _{COM}	440	Ω	max.
Nennspannung / rated voltage		U _{DC}	80	V	max.

C Lötpad / Land pattern.:

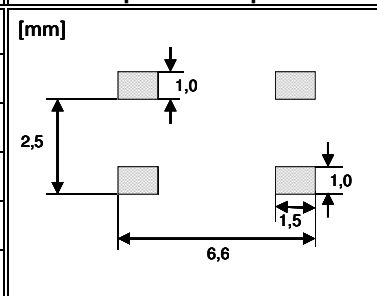

D Prüfgeräte / test equipment:

Agilent E4991A für/for Z und/and material
GMC Metrahit 271 für/for R_{DC} und/and IDC
Wayne Kerr 3260B für/for L

E Testbedingungen / test conditions:

Luftfeuchtigkeit / humidity: 33%
 Umgebungstemperatur / temperature: +20 °C
 High-Pot Test (60 Hz, 3 mA, 1 min.): 250 VAC

F Werkstoffe & Zulassungen / material & approvals:

Basismaterial / base material: Ferrit / ferrite
 Draht / wire: 2-SFBW / 155 °C
 Gehäuse / Housing: UL94 V-0

G Eigenschaften / general specifications:

Betriebstemp. / operating temperature: -40 °C - +105 °C
 Umgebungstemp. / ambient temperature: -40 °C - +85 °C
 It is recommended that the temperature of the part does not exceed 105 °C under worst case operating conditions.

Freigabe erteilt / general release:	Kunde / customer		
	SBa	Version 7	2010-11-03
.....	BKO	Version 6	2008-12-04
	MST	Version 5	2007-02-02
Datum / date	Unterschrift / signature		
	SSi	Version 4	2006-01-31
.....	Würth Elektronik		
	MST	Version 3	2005-05-25
.....	MST	Version 2	2004-10-11
	ME	Version 1	2004-04-26
Geprüft / checked	Kontrolliert / approved		Name
			Änderung / modification
			Datum / date

Würth Elektronik eiSos GmbH & Co. KG

D-74638 Waldenburg · Max-Eyth-Strasse 1 - 3 · Germany · Telefon (+49) (0) 7942 - 945 - 0 · Telefax (+49) (0) 7942 - 945 - 400

Spezifikation für Freigabe / specification for release

Kunde / customer :
 Artikelnummer / part number : **744212820**
 Bezeichnung : **STROMKOMP. SMD LINE FILTER WE-SL1**
 description : **COMMON MODE SMD LINE FILTER WE-SL1**



DATUM / DATE : 2010-11-03

H Impedanzverlauf / impedance curve:

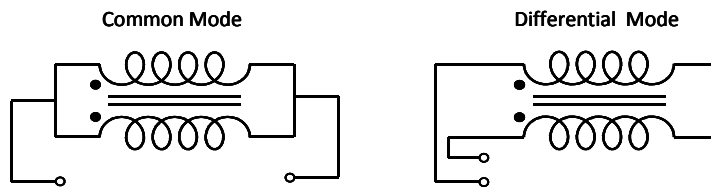
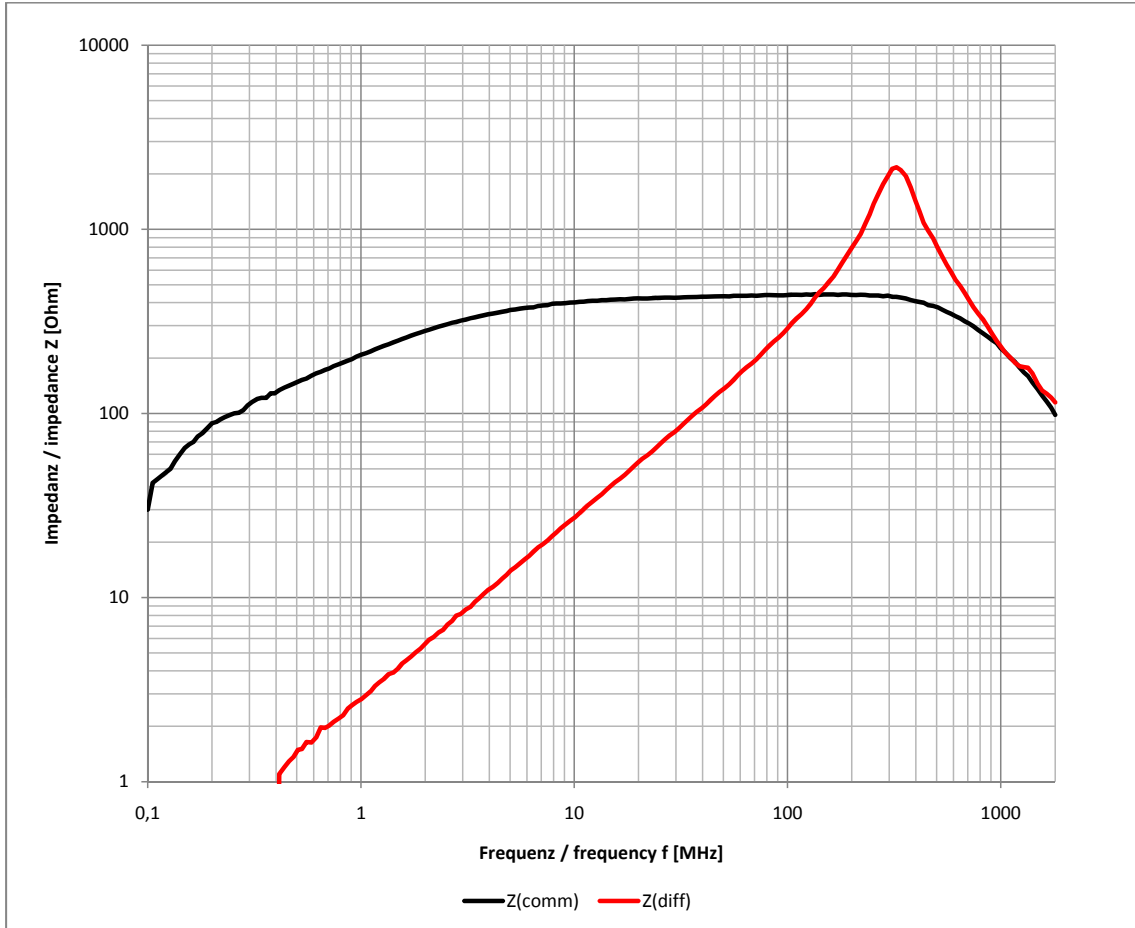

Freigabe erteilt / general release:	Kunde / customer			
		SBa	Version 7	2010-11-03
		BKO	Version 6	2008-12-04
		MST	Version 5	2007-02-02
Datum / date	Unterschrift / signature	SSt	Version 4	2006-01-31
	Würth Elektronik	MST	Version 3	2005-05-25
		MST	Version 2	2004-10-11
		ME	Version 1	2004-04-26
Geprüft / checked	Kontrolliert / approved	Name	Änderung / modification	Datum / date

Würth Elektronik eiSos GmbH & Co. KG

D-74638 Waldenburg · Max-Eyth-Strasse 1 - 3 · Germany · Telefon (+49) (0) 7942 - 945 - 0 · Telefax (+49) (0) 7942 - 945 - 400

Spezifikation für Freigabe / specification for release

Kunde / customer :

Artikelnummer / part number : **744212820**

Bezeichnung : **STROMKOMP. SMD LINE FILTER WE-SL1**
 description : **COMMON MODE SMD LINE FILTER WE-SL1**



DATUM / DATE : 2010-11-03

I Rollenspezifikation / tape and reel specification:

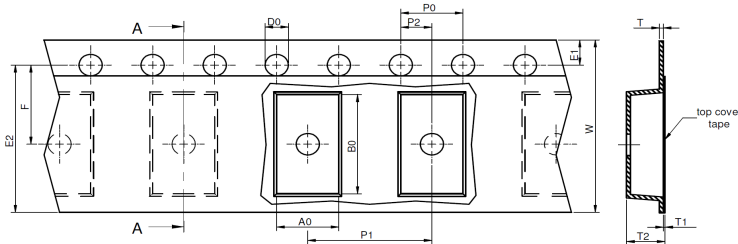

Gurtspezifikation / Tape specification:

A0	4,00 typ.	mm
B0	6,90 typ.	mm
W	12,00 +0,3/-0,1	mm
P1	8,00 ± 0,10	mm
T	0,40 ± 0,10	mm
T1	0,10 max.	mm
T2	2,35 typ.	mm
D0	1,50 +0,1/-0,0	mm
E1	1,75 ± 0,1	mm
E2	10,25 min.	mm
F	5,50 ± 0,05	mm
P0	4,00 ± 0,10	mm
P2	2,00 ± 0,05	mm

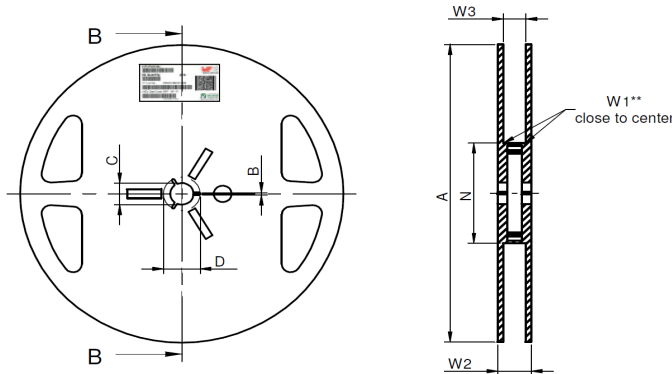

Rollenspezifikation / Reel specification:

A	178,00	mm
B	1,50 min.	mm
C	13,00 ± 0,80	mm
D	20,20 min.	mm
N	50,00 min.	mm
W1	12,40 +1,5	mm
W2	18,40 max.	mm
W3	11,90 min.	mm
W3	15,40 max.	mm

165 to 180

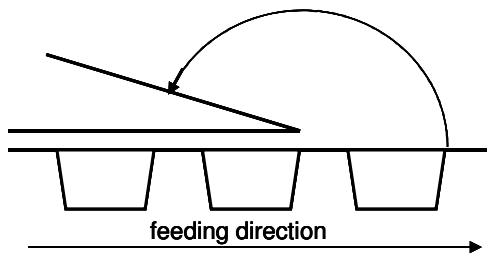

The force for tearing off cover tape is 10 to 130 grams in arrow direction

Freigabe erteilt / general release:	Kunde / customer		
	SBa	Version 7	2010-11-03
Datum / date	Unterschrift / signature		
	Würth Elektronik		
Geprüft / checked	Kontrolliert / approved		
	Name	Änderung / modification	Datum / date
	BKO	Version 6	2008-12-04
	MST	Version 5	2007-02-02
	SSt	Version 4	2006-01-31
	MST	Version 3	2005-05-25
	MST	Version 2	2004-10-11
	ME	Version 1	2004-04-26

This electronic component has been designed and developed for usage in general electronic equipment. Before incorporating this component into any equipment where higher safety and reliability is especially required or if there is the possibility of direct damage or injury to human body, for example in the range of aerospace, aviation, nuclear control, submarine, transportation, (automotive control, train control, ship control), transportation signal, disaster prevention, medical, public information network etc, Würth Elektronik eiSos GmbH must be informed before the design-in stage. In addition, sufficient reliability evaluation checks for safety must be performed on every electronic component which is used in electrical circuits that require high safety and reliability functions or performance.

Würth Elektronik eiSos GmbH & Co. KG

D-74638 Waldenburg · Max-Eyth-Strasse 1 - 3 · Germany · Telefon (+49) (0) 7942 - 945 - 0 · Telefax (+49) (0) 7942 - 945 - 400
<http://www.we-online.com>