

# Spezifikation für Freigabe / specification for release

Kunde / customer :

Artikelnummer / part number : **744212100**



Bezeichnung : **STROMKOMP. SMD LINE FILTER WE-SL1**  
 description : **COMMON MODE SMD LINE FILTER WE-SL1**

DATUM / DATE : 2010-11-03

## A Mechanische Abmessungen / dimensions:

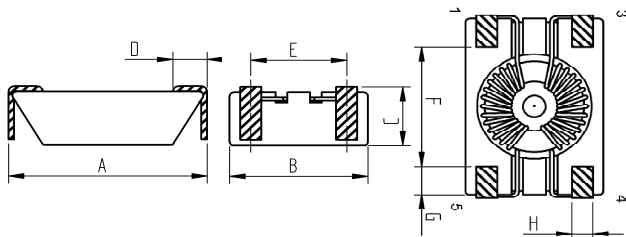

|   |                    |    |
|---|--------------------|----|
| A | <b>6,50 max.</b>   | mm |
| B | <b>3,60 ± 0,15</b> | mm |
| C | <b>1,65 ± 0,15</b> | mm |
| D | <b>0,90 min.</b>   | mm |
| E | <b>2,50 ± 0,15</b> | mm |
| F | <b>3,40 ± 0,20</b> | mm |
| G | <b>0,80 max.</b>   | mm |
| H | <b>0,55 ± 0,10</b> | mm |

## B Elektrische Eigenschaften / electrical properties:

| Eigenschaften / properties    | Testbedingungen / test conditions |                      | Wert / value | Einheit / unit | tol. |
|-------------------------------|-----------------------------------|----------------------|--------------|----------------|------|
| Induktivität / inductance     | <b>100 mV / 100 kHz</b>           | L <sub>1-5,3-4</sub> | <b>10</b>    | μH             | ±50% |
| DC-Widerstand / DC-resistance |                                   | R <sub>DC</sub>      | <b>0,24</b>  | Ω              | max. |
| Nennstrom / rated current     | <b>ΔT= 20K</b>                    | I <sub>DC</sub>      | <b>300</b>   | mA             | max. |
| Impedanz / impedance          |                                   | Z <sub>COM</sub>     | <b>1200</b>  | Ω              | max. |
| Nennspannung / rated voltage  |                                   | U <sub>DC</sub>      | <b>80</b>    | V              | max. |

## C Lötpad / Land pattern.:

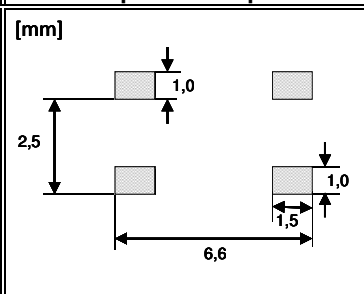

## D Prüfgeräte / test equipment:

**Agilent E4991A** für/for Z und/and material  
**GMC Metrahit 271** für/for R<sub>DC</sub> und/and IDC  
**Wayne Kerr 3260B** für/for L

## E Testbedingungen / test conditions:

Luftfeuchtigkeit / humidity: 33%  
 Umgebungstemperatur / temperature: +20 °C  
 High-Pot Test (60 Hz, 3 mA, 1 min.): 250 VAC

## F Werkstoffe & Zulassungen / material & approvals:

Basismaterial / base material: Ferrit / ferrite  
 Draht / wire: 2-SFBW / 155 °C  
 Gehäuse / Housing: UL94 V-0

## G Eigenschaften / general specifications:

Betriebstemp. / operating temperature: -40 °C - +105 °C  
 Umgebungstemp. / ambient temperature: -40 °C - +85 °C  
 It is recommended that the temperature of the part does not exceed 105 °C under worst case operating conditions.

|                                     |                          |                         |              |
|-------------------------------------|--------------------------|-------------------------|--------------|
| Freigabe erteilt / general release: | <b>Kunde / customer</b>  |                         |              |
|                                     | SBa                      | Version 7               | 2010-11-03   |
| .....                               | BKO                      | Version 6               | 2008-12-04   |
|                                     | MST                      | Version 5               | 2007-02-02   |
| Datum / date                        | Unterschrift / signature |                         |              |
|                                     | SSi                      | Version 4               | 2006-01-31   |
| .....                               | <b>Würth Elektronik</b>  |                         |              |
|                                     | MST                      | Version 3               | 2005-05-25   |
| .....                               | MST                      | Version 2               | 2004-10-11   |
|                                     | ME                       | Version 1               | 2004-04-26   |
| Geprüft / checked                   | Kontrolliert / approved  |                         |              |
|                                     | Name                     | Änderung / modification | Datum / date |

### Würth Elektronik eiSos GmbH & Co. KG

D-74638 Waldenburg · Max-Eyth-Strasse 1 - 3 · Germany · Telefon (+49) (0) 7942 - 945 - 0 · Telefax (+49) (0) 7942 - 945 - 400

# Spezifikation für Freigabe / specification for release

Kunde / customer :  
 Artikelnummer / part number : **744212100**  
 Bezeichnung : **STROMKOMP. SMD LINE FILTER WE-SL1**  
 description : **COMMON MODE SMD LINE FILTER WE-SL1**



DATUM / DATE : 2010-11-03

## H Impedanzverlauf / impedance curve:

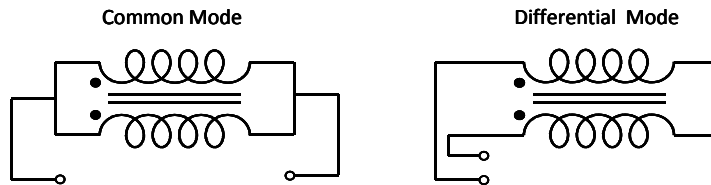
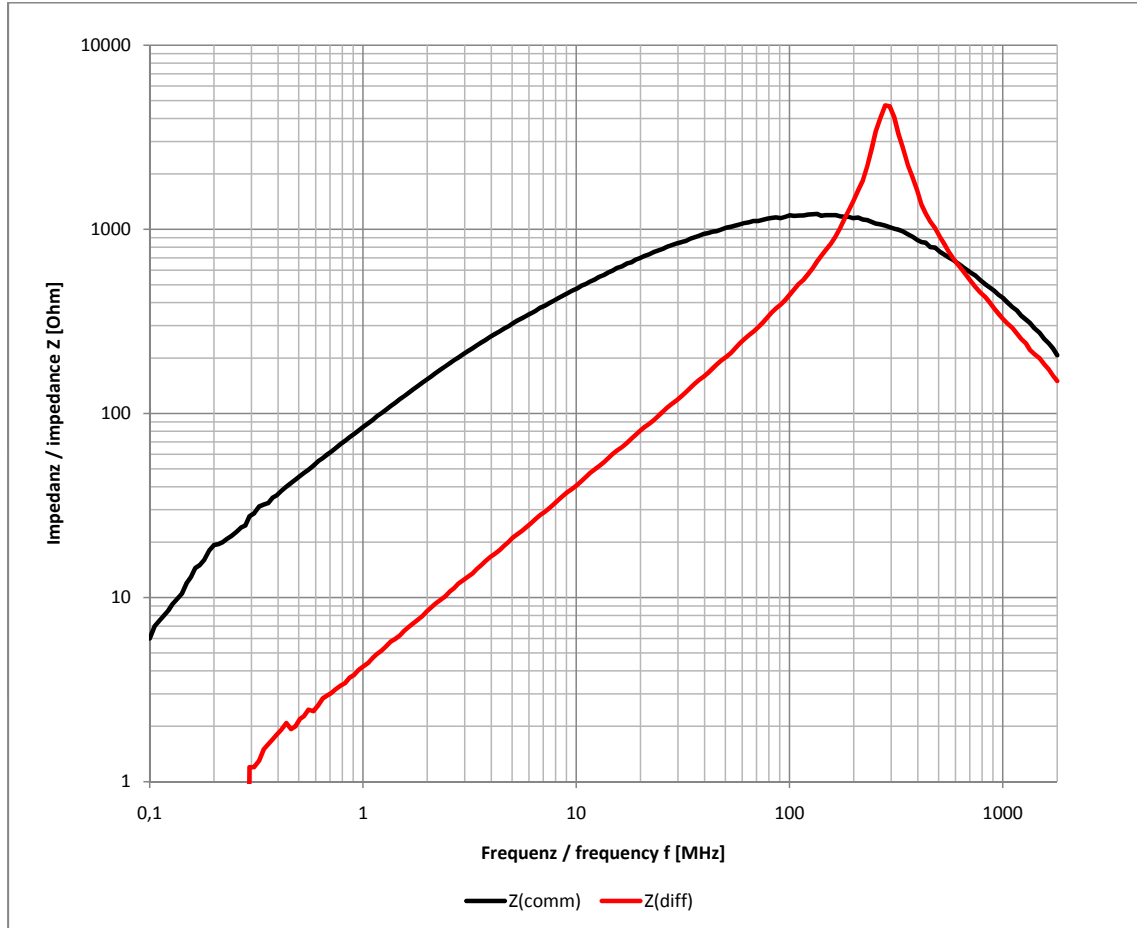

|                                     |                          |      |                         |              |
|-------------------------------------|--------------------------|------|-------------------------|--------------|
| Freigabe erteilt / general release: | <b>Kunde / customer</b>  |      |                         |              |
|                                     |                          | SBa  | Version 7               | 2010-11-03   |
|                                     |                          | BKO  | Version 6               | 2008-12-04   |
|                                     |                          | MST  | Version 5               | 2007-02-02   |
| Datum / date                        | Unterschrift / signature | SSt  | Version 4               | 2006-01-31   |
|                                     | <b>Würth Elektronik</b>  | MST  | Version 3               | 2005-05-25   |
|                                     |                          | MST  | Version 2               | 2004-10-11   |
|                                     |                          | ME   | Version 1               | 2004-04-26   |
| Geprüft / checked                   | Kontrolliert / approved  | Name | Änderung / modification | Datum / date |

### Würth Elektronik eiSos GmbH & Co. KG

D-74638 Waldenburg · Max-Eyth-Strasse 1 - 3 · Germany · Telefon (+49) (0) 7942 - 945 - 0 · Telefax (+49) (0) 7942 - 945 - 400

# Spezifikation für Freigabe / specification for release

Kunde / customer :

Artikelnummer / part number : **744212100**

Bezeichnung : **STROMKOMP. SMD LINE FILTER WE-SL1**  
 description : **COMMON MODE SMD LINE FILTER WE-SL1**



DATUM / DATE : 2010-11-03

## I Rollenspezifikation / tape and reel specification:

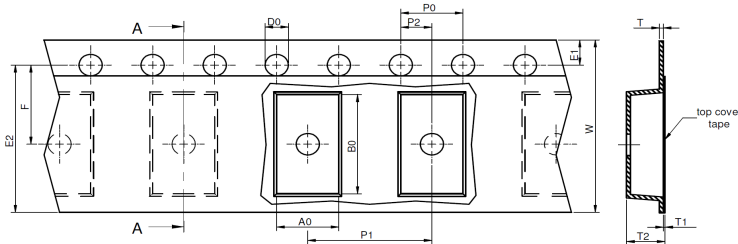

### Gurtspezifikation / Tape specification:

|    |                        |    |
|----|------------------------|----|
| A0 | <b>4,00 typ.</b>       | mm |
| B0 | <b>6,90 typ.</b>       | mm |
| W  | <b>12,00 +0,3/-0,1</b> | mm |
| P1 | <b>8,00 ± 0,10</b>     | mm |
| T  | <b>0,40 ± 0,10</b>     | mm |
| T1 | <b>0,10 max.</b>       | mm |
| T2 | <b>2,35 typ.</b>       | mm |
| D0 | <b>1,50 +0,1/-0,0</b>  | mm |
| E1 | <b>1,75 ± 0,1</b>      | mm |
| E2 | <b>10,25 min.</b>      | mm |
| F  | <b>5,50 ± 0,05</b>     | mm |
| P0 | <b>4,00 ± 0,10</b>     | mm |
| P2 | <b>2,00 ± 0,05</b>     | mm |

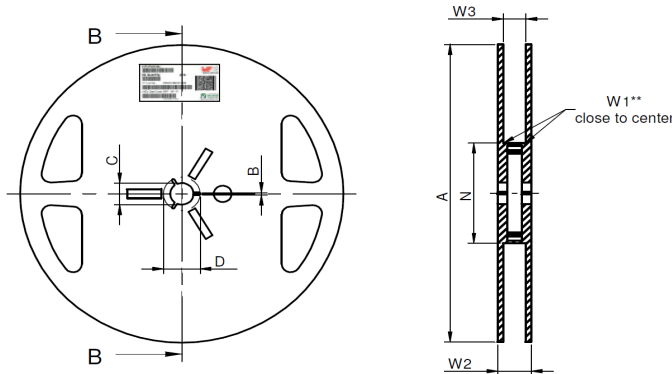

### Rollenspezifikation / Reel specification:

|    |                     |    |
|----|---------------------|----|
| A  | <b>178,00</b>       | mm |
| B  | <b>1,50 min.</b>    | mm |
| C  | <b>13,00 ± 0,80</b> | mm |
| D  | <b>20,20 min.</b>   | mm |
| N  | <b>50,00 min.</b>   | mm |
| W1 | <b>12,40 +1,5</b>   | mm |
| W2 | <b>18,40 max.</b>   | mm |
| W3 | <b>11,90 min.</b>   | mm |
| W3 | <b>15,40 max.</b>   | mm |

165 to 180

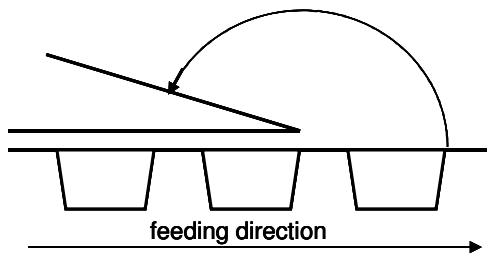

The force for tearing off cover tape is 10 to 130 grams in arrow direction

|                                     |                          |                         |              |
|-------------------------------------|--------------------------|-------------------------|--------------|
| Freigabe erteilt / general release: | Kunde / customer         |                         |              |
|                                     | SBa                      | Version 7               | 2010-11-03   |
| Datum / date                        | Unterschrift / signature |                         |              |
|                                     | BKO                      | Version 6               | 2008-12-04   |
| Geprüft / checked                   | Würth Elektronik         |                         |              |
|                                     | MST                      | Version 5               | 2007-02-02   |
|                                     | SSt                      | Version 4               | 2006-01-31   |
|                                     | MST                      | Version 3               | 2005-05-25   |
|                                     | MST                      | Version 2               | 2004-10-11   |
|                                     | ME                       | Version 1               | 2004-04-26   |
|                                     | Name                     | Änderung / modification | Datum / date |

This electronic component has been designed and developed for usage in general electronic equipment. Before incorporating this component into any equipment where higher safety and reliability is especially required or if there is the possibility of direct damage or injury to human body, for example in the range of aerospace, aviation, nuclear control, submarine, transportation, (automotive control, train control, ship control), transportation signal, disaster prevention, medical, public information network etc, Würth Elektronik eiSos GmbH must be informed before the design-in stage. In addition, sufficient reliability evaluation checks for safety must be performed on every electronic component which is used in electrical circuits that require high safety and reliability functions or performance.

**Würth Elektronik eiSos GmbH & Co. KG**

D-74638 Waldenburg · Max-Eyth-Strasse 1 - 3 · Germany · Telefon (+49) (0) 7942 - 945 - 0 · Telefax (+49) (0) 7942 - 945 - 400  
<http://www.we-online.com>