

Belling Lee

SF 4200

2 STAGE, HIGH PERFORMANCE CHASSIS MOUNTED FILTER H' VERSION OFFERING OUTSTANDING PERFORMANCE

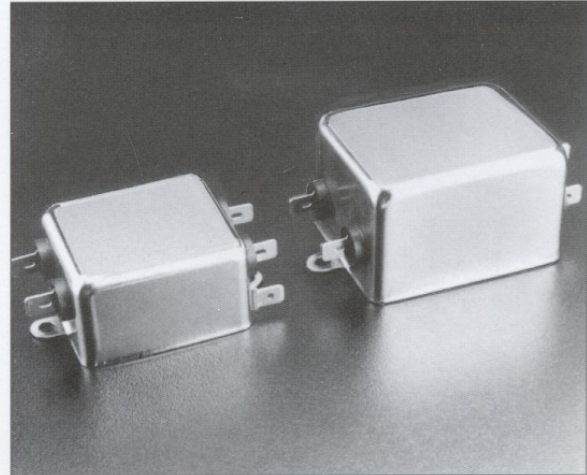
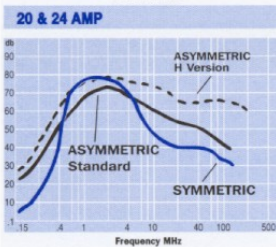
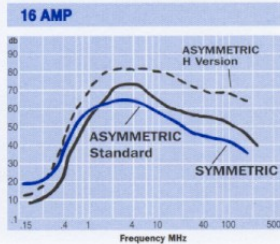
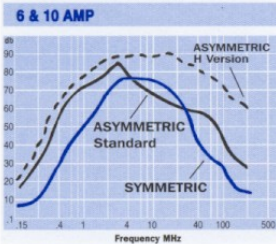
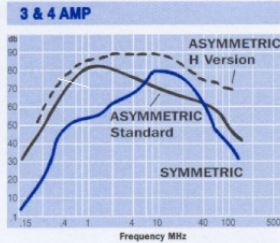
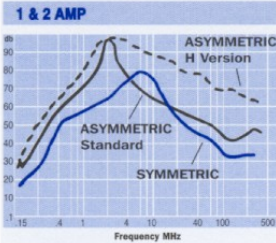

SF 4200	Rated Current A	Leakage Current @ 250V 50Hz	Inductance mH L1	L2	Connections	Resistor Value MΩ	Approvals			
SF 4200-1/01	1	0.2mA	4.3	4.3	6.3 x 0.8 Faston	1	<input checked="" type="checkbox"/>	<input checked="" type="checkbox"/>	<input checked="" type="checkbox"/>	<input checked="" type="checkbox"/>
SF 4200-2/01	2	0.2mA	2.2	2.2	6.3 x 0.8 Faston	1	<input checked="" type="checkbox"/>	<input checked="" type="checkbox"/>	<input checked="" type="checkbox"/>	<input checked="" type="checkbox"/>
SF 4200-3/01	3	0.2mA	2.2	2.2	6.3 x 0.8 Faston	1	<input checked="" type="checkbox"/>	<input checked="" type="checkbox"/>	<input checked="" type="checkbox"/>	<input checked="" type="checkbox"/>
SF 4200-4/01	4	0.2mA	2.2	2.2	6.3 x 0.8 Faston	1	<input checked="" type="checkbox"/>	<input checked="" type="checkbox"/>	<input checked="" type="checkbox"/>	<input checked="" type="checkbox"/>
SF 4200-6/01	6	0.2mA	1.3	1.3	6.3 x 0.8 Faston	1	<input checked="" type="checkbox"/>	<input checked="" type="checkbox"/>	<input checked="" type="checkbox"/>	<input checked="" type="checkbox"/>
SF 4200-10/01	10	0.2mA	1.0	1.0	6.3 x 0.8 Faston	1	<input checked="" type="checkbox"/>	<input checked="" type="checkbox"/>	<input checked="" type="checkbox"/>	<input checked="" type="checkbox"/>
SF 4200-16/01	16	0.2mA	0.45	0.45	6.3 x 0.8 Faston	1	<input checked="" type="checkbox"/>	<input checked="" type="checkbox"/>	<input checked="" type="checkbox"/>	<input checked="" type="checkbox"/>
SF 4200-16/04	16	0.2mA	0.45	0.45	M4 Stud	1	<input checked="" type="checkbox"/>	<input checked="" type="checkbox"/>	<input checked="" type="checkbox"/>	<input checked="" type="checkbox"/>
SF 4200-20/04	20	0.2mA	0.68	0.68	M4 Stud	1	<input checked="" type="checkbox"/>	<input checked="" type="checkbox"/>	<input checked="" type="checkbox"/>	<input checked="" type="checkbox"/>
SF 4200-24/04	24	0.2mA	0.45	0.45	M4 Stud	1	<input checked="" type="checkbox"/>	<input checked="" type="checkbox"/>	<input checked="" type="checkbox"/>	<input checked="" type="checkbox"/>
Higher Performance										
SF 4200H-1/01	1	0.4mA	4.3	4.3	6.3 x 0.8 Faston	1	<input checked="" type="checkbox"/>	<input checked="" type="checkbox"/>	<input checked="" type="checkbox"/>	<input checked="" type="checkbox"/>
SF 4200H-2/01	2	0.4mA	2.2	2.2	6.3 x 0.8 Faston	1	<input checked="" type="checkbox"/>	<input checked="" type="checkbox"/>	<input checked="" type="checkbox"/>	<input checked="" type="checkbox"/>
SF 4200H-3/01	3	0.4mA	2.2	2.2	6.3 x 0.8 Faston	1	<input checked="" type="checkbox"/>	<input checked="" type="checkbox"/>	<input checked="" type="checkbox"/>	<input checked="" type="checkbox"/>
SF 4200H-4/01	4	0.4mA	2.2	2.2	6.3 x 0.8 Faston	1	<input checked="" type="checkbox"/>	<input checked="" type="checkbox"/>	<input checked="" type="checkbox"/>	<input checked="" type="checkbox"/>
SF 4200H-6/01	6	0.4mA	1.3	1.3	6.3 x 0.8 Faston	1	<input checked="" type="checkbox"/>	<input checked="" type="checkbox"/>	<input checked="" type="checkbox"/>	<input checked="" type="checkbox"/>
SF 4200H-10/01	10	0.4mA	1.0	1.0	6.3 x 0.8 Faston	1	<input checked="" type="checkbox"/>	<input checked="" type="checkbox"/>	<input checked="" type="checkbox"/>	<input checked="" type="checkbox"/>
SF 4200H-16/01	16	0.4mA	0.45	0.45	6.3 x 0.8 Faston	1	<input checked="" type="checkbox"/>	<input checked="" type="checkbox"/>	<input checked="" type="checkbox"/>	<input checked="" type="checkbox"/>
SF 4200H-16/04	16	0.4mA	0.45	0.45	M4 Stud	1	<input checked="" type="checkbox"/>	<input checked="" type="checkbox"/>	<input checked="" type="checkbox"/>	<input checked="" type="checkbox"/>
SF 4200H-20/04	20	0.4mA	0.68	0.68	M4 Stud	1	<input checked="" type="checkbox"/>	<input checked="" type="checkbox"/>	<input checked="" type="checkbox"/>	<input checked="" type="checkbox"/>
SF 4200H-24/04	24	0.4mA	0.45	0.45	M4 Stud	1	<input checked="" type="checkbox"/>	<input checked="" type="checkbox"/>	<input checked="" type="checkbox"/>	<input checked="" type="checkbox"/>

Temperature Range: -25°C to +85°C
 Operating Voltage: 250Vac
 Operating Frequency: 0 to 400Hz
 Test Voltage: L+N to ground, 2700Vdc, 2 seconds

Approved Submitted for Approval

IEC 950 (EN 60950 Applications)

Continued on next page

FOR MORE INFORMATION PLEASE PHONE **01638 665161**

Belling Lee SF 4200

Continued from previous page

DIMENSIONS

All dimensions are nominal and in mm

SF 4200 -1/01 & -2/01

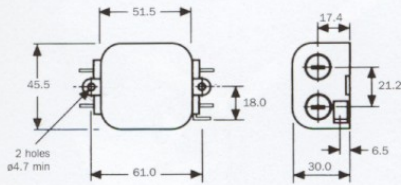

SF 4200 -3/01, -4/01 & -6/01

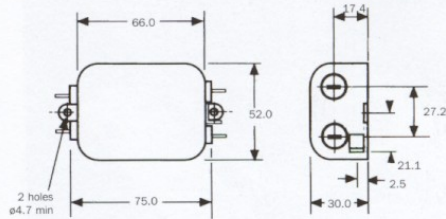

SF 4200 -10/01 & -16/01

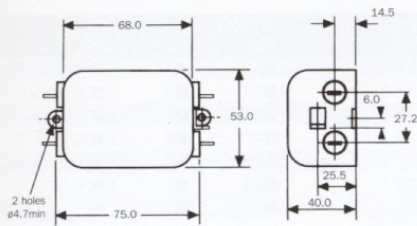

SF 4200 -16/04

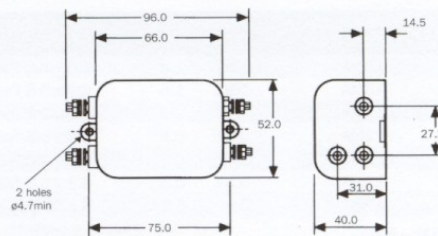

SF 4200-20/04 & SF 4200-24/04

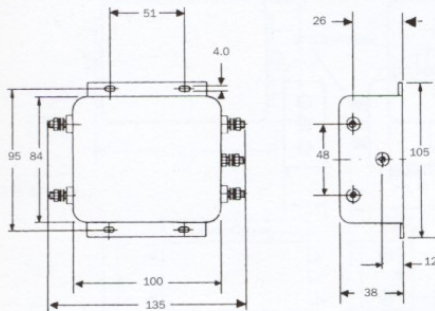

CIRCUIT DIAGRAMS

Standard Version

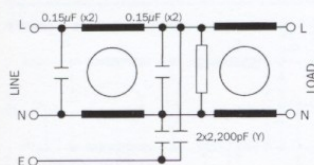

Higher Performance Version 1 to 6A

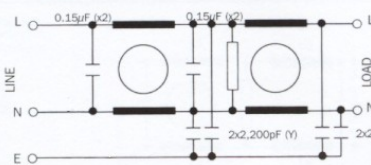

Higher Performance Version 10 to 24A

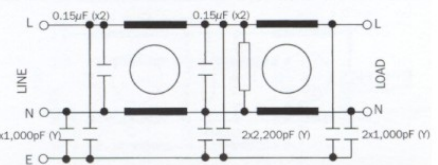

FOR MORE INFORMATION PLEASE PHONE **01638 665161**