

Two-stage filter

FN 343

- 1 to 10A current ratings
- 2-stage design with earth line choke
- Nennströme von 1 bis 10A
- Zweistufen-Design mit Erdleiterdrossel
- Courants de service de 1 à 10A
- Conception à double-étage avec self de terre



Filter selection table

Choose the family FN xxx with the required current rating and features, and add /?? to determine input/output (line/load) connection style. Example: FN 343-3/01 is a 3A filter with solder lug connections.

Approvals



Family	Connections 	Current ratings at 40°C (25°) A	Inductance L/L ₁ /L ₂ mH	Housing	Weight g
FN 343 -1 /??	/05	1 (1.15)	5.6/10/0.4	J2	160
FN 343 -3 /??	/05	3 (3.4)	1.1/2/0.4	J2	160
FN 343 -6 /??	/05	6 (6.9)	0.43/0.77/0.4	J2	160
FN 343 -10 /??	/05	10 (11.5)	0.27/0.66/0.4	J2	170

Additional specifications

Filter type	Capacitance		Res. R MΩ	Maximum leakage μA/phase	Maximum operating voltage		Operating frequency Hz	Hipot test voltage	
	C _x /C _{x1} nF	C _y nF			VAC	Hz		PN→E VAC	P→N VAC
Standard types	100/100	2.2	1	190	250	50/60	DC to 400	2000	760

MTBF at 40°C, 230V, per Mil-HB-217F: 970,000 hours.

FN 343 insertion loss

Per CISPR 17; A = 50Ω/50Ω sym, B = 50Ω/50Ω asym, C = 0.1Ω/100Ω sym, D = 100Ω/0.1Ω sym

1 amp types

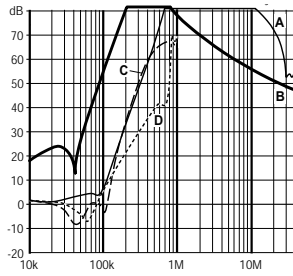

3 amp types

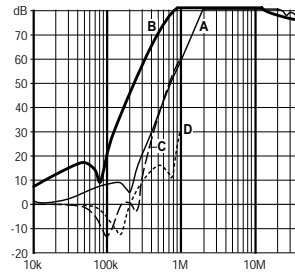

6 amp types

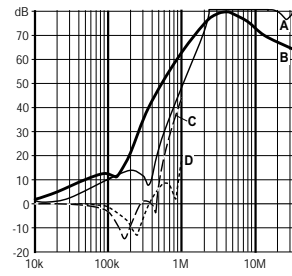

10 amp types

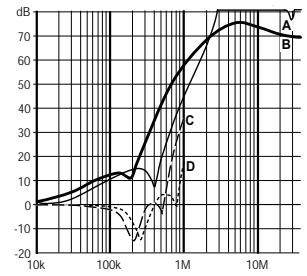

Electrical schematic

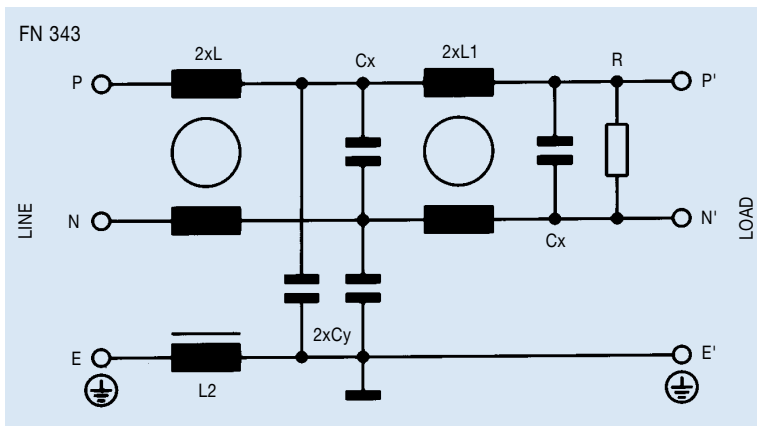

See tables for component values.

Mechanical data

		Tol. mm
A	70	± 0.5
B	69	± 0.5
C	30.3	± 1
D	64.8	± 1
E	88.2	± 1
F	60	± 0.2
J	27	± 0.5
K	12.3	± 0.5
M	5.3	± 0.1
N	6.3	± 0.1

Front view

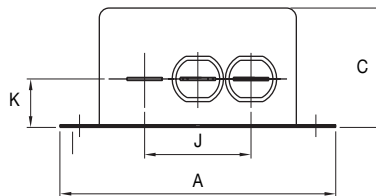

Top view

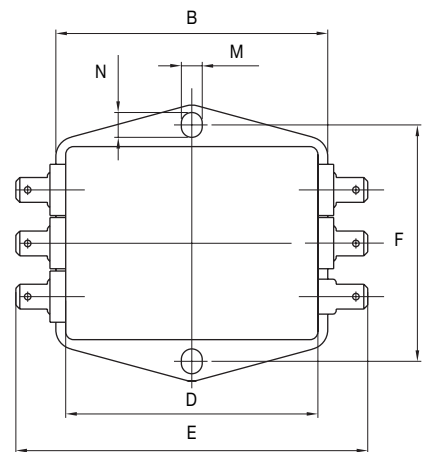

All dimensions in mm; 1 inch = 25.4 mm