

# Multi-stage general-purpose filter FN 2060

- Current ratings from 1 to 30A
  - High differential and common mode attenuation
  - Optional medical versions (B types)
  - Optional safety versions (A types)
- 
- Nennströme von 1 bis 30A
  - Hohe Gleich- und Gegentaktdämpfung
  - Optionale medizinische Versionen (Typ B)
  - Optionale Sicherheitsversionen (Typ A)
- 
- Courants de service de 1 à 30A
  - Bonne atténuation en modes différentiel et commun
  - En option version pour appareils médicaux (type B)
  - En option version pour la sécurité (type A)



## Filter selection table

Choose the filter FN xxxx-x with the required current rating and features, and add /?? to determine input/output (line/load) connection style. Example: FN 2060-10/06 is a 10A filter with fast-on connections.

## Approvals



Filter	Connections			Current ratings at 40°C (25°) A	Inductance L mH	Capacitance		Resistance R MΩ	Housing	Weight g
						Cx μF	Cy nF			
FN 2060 -1 /??	/06	/07		1 (1.15)	12	0.22	4.7	1	H2	120
FN 2060 -3 /??	/06	/07		3 (3.45)	2.5	0.22	4.7	1	H2	120
FN 2060 -6 /??	/06	/07		6 (6.9)	0.97	0.22	4.7	1	H2	120
FN 2060 -10 /??	/06	/07		10 (11.5)	0.8	0.47	4.7	0.47	K1	190
FN 2060 -12 /??	/06	/07		12 (13.8)	0.58	0.47	4.7	0.47	K1	190
FN 2060 -16 /??	/06	/07	/08	16 (18.4)	0.65	0.33	4.7	1	K2	260
FN 2060 -20 /??	/06		/08	20 (23)	0.6	1	4.7	0.22	P	480
FN 2060 -30 /??			/08	30 (34.5)	0.6	1	10	0.22	L2	950

## Additional specifications

Filter type	Maximum operating voltage		Operating frequency Hz	Hipot test voltage		MTBF Per Mil-HB-217F at 40°C 230V hours	Maximum leakage mA/phase
	VAC	Hz		PN→E VAC	P→N VDC		
Standard types	250	50/60	DC to 400	2000	1700	950 000	0.4*
B medical types (no Y capacitors)	250	50/60	DC to 400	2500	1700	1 650 000	0.002
A safety types (lower capacitance)	250	50/60	DC to 400	2500	1700	950 000	0.040

\* 1mA for 30A version

## Electrical schematic

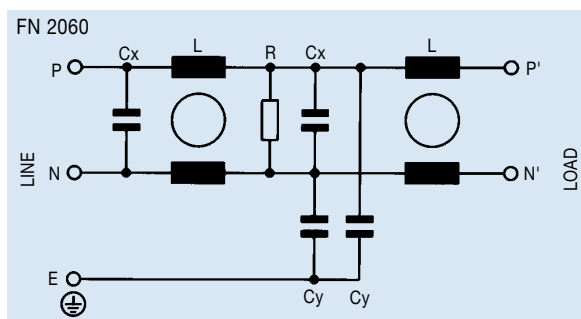

See tables for component values.

## FN 2060 insertion loss

Per CISPR 17; A = 50Ω/50Ω sym, B = 50Ω/50Ω asym, C = 0.1Ω/100Ω sym, D = 100Ω/0.1Ω sym

### 1A types

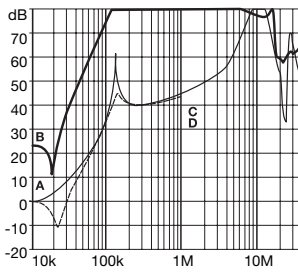

### 3A types

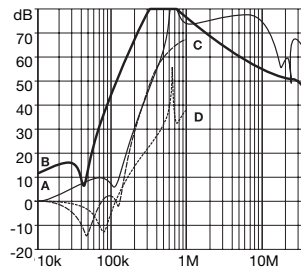

### 6A types

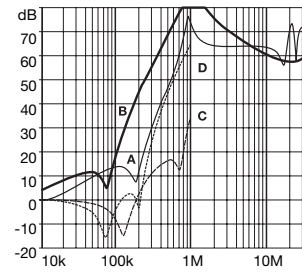

### 10A types (12A\*)

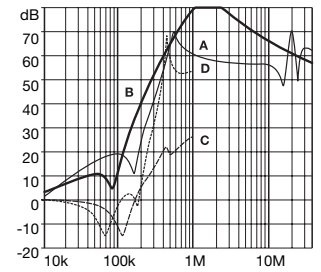

### 16A types

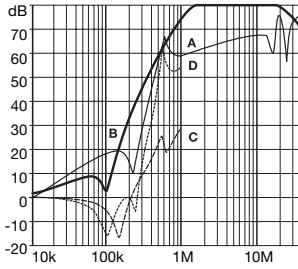

### 20A types

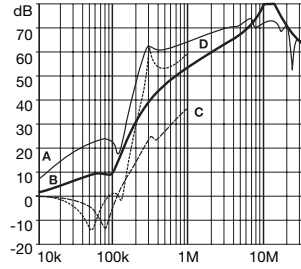

### 30A types

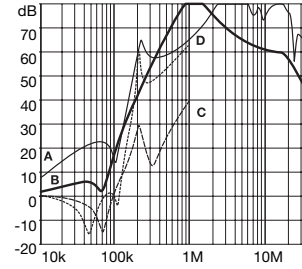

\* attenuation performance of the 12A version is similar to the 10A component.

## Mechanical data

Housing style	H2	K1	K2	Tol. ± mm
A	71	85		± 0.5
B	46.6	54		± 0.5
C	29.3	30.3	40.3	± 0.5
D	50.5	64.8		± 0.5
F	61	75		± 0.3
J	21	27		± 0.2
K	10.8/8.3 <sup>§</sup>	12.3/8.3 <sup>§</sup>		± 0.5
L	19.3	20.8/23.3	29.8	± 0.5
M		5.3		± 0.1
N		6.3		± 0.1
P		0.7		± 0.1
S	20.1/30.5 <sup>§</sup>	19.9/34.9 <sup>§</sup>	11.4/34.9 <sup>§</sup>	± 0.5

<sup>§</sup> with /07 connections  
wire length of /07: 140 +5 mm

### Front

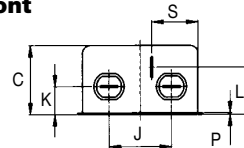

### Top

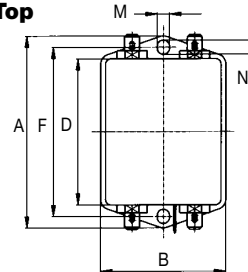

Housings H2, K1 and K2

Housing style	P	L2	Tol.* ± mm
A	113.5	119 ± 0.5	± 1
B	57.5	85.5	± 1
C	45.4 ± 1.2	57.6	± 1
D	94	98.5	± 1
F	103	109	± 0.3
J	25	40	± 0.2
K	12.4	15.6	± 0.5
L	32.4		± 0.5
M	4.4	4.4	± 0.1
N	6	7.4	± 0.1
P	0.9	1.2	± 0.1
Q		66	± 0.3
R		51	± 0.2
S	15.5		± 0.5

\* Measurements share this common tolerance unless otherwise stated.

### Front

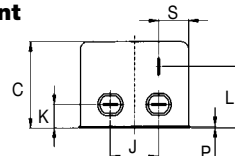

### Top

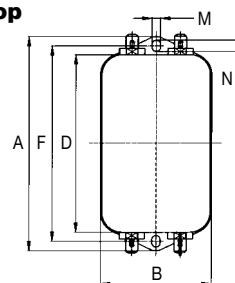

Housing P

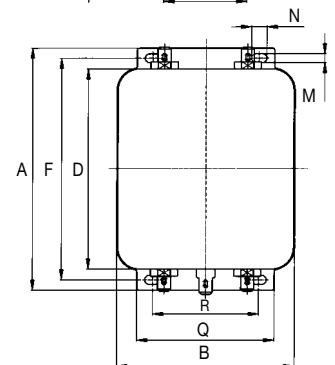
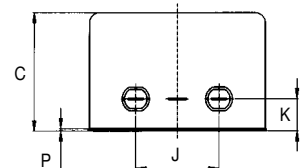

Housing L2

All dimensions in mm; 1 inch = 25.4 mm