

**tyco**

Electronics

## BCF Series

Very compact  
3-Phase Filter Series  
for universal application

*Sehr kompakter Dreiphasenfilter  
für den universellen Einsatz*

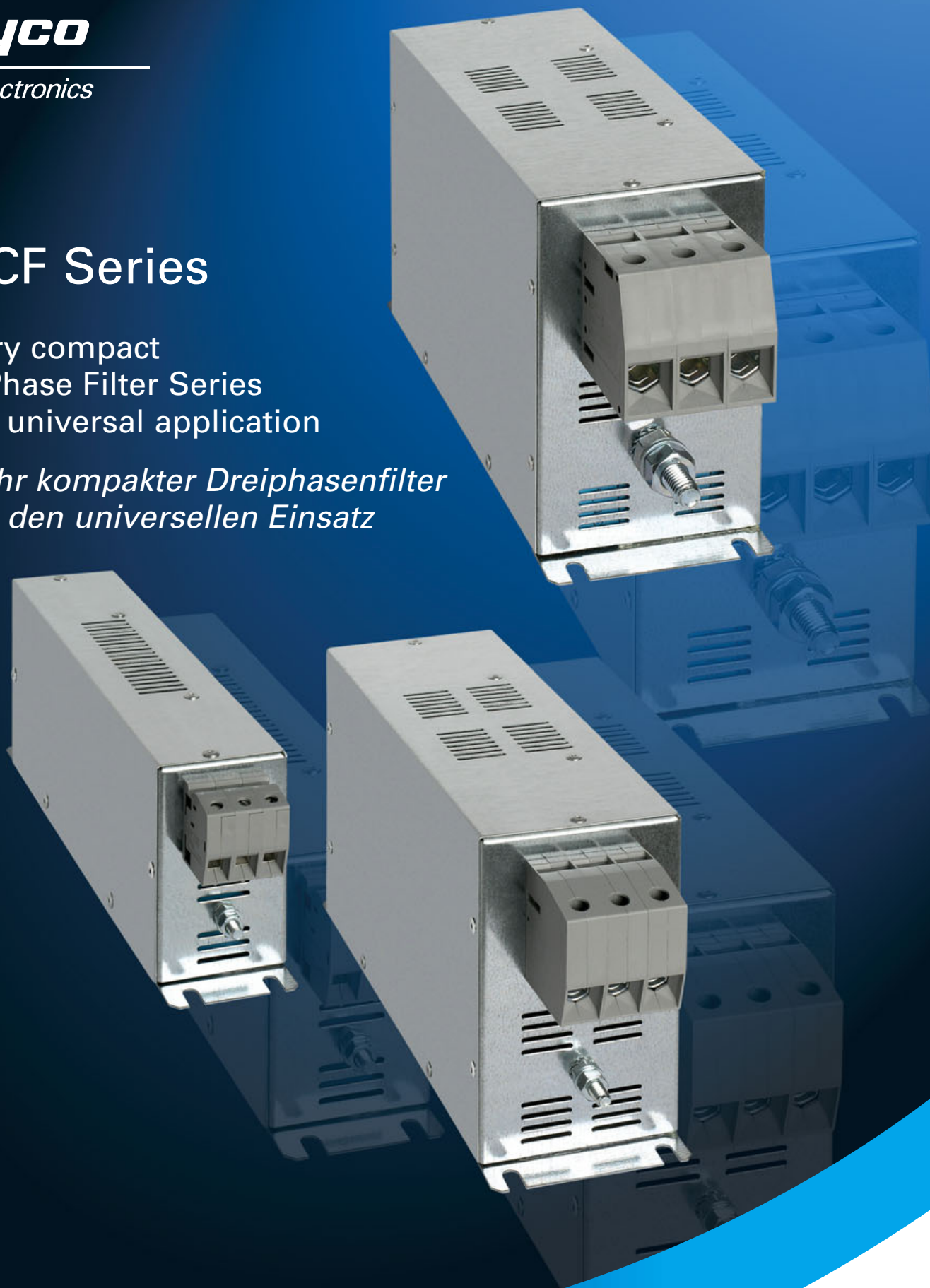

**corcom**

**General Information / Allgemeine Informationen**

- |  |  |
|--|--|
| ■ Very compact bookform filter   | ■ <i>Sehr kompakter Buchform-Filter</i>  |
| ■ Low weight design  | ■ <i>Geringes Gewicht</i>  |
| ■ Insulated, high quality safety terminals for in- and output  | ■ <i>Isolierte, hoch qualitative Sicherheitsklemmen auf der Ein- und Ausgangsseite</i>   |
| ■ For current rating up to 180 A   | ■ <i>Für Stromstärken bis zu 180 A</i>   |
| ■ Cost effective design  | ■ <i>Kostenoptimiertes Design</i>  |
| ■ Ideal for all kinds of industrial 3-phase applications requiring very high attenuation in the frequency range between 100 KHz and 30 MHz | ■ <i>Hervorragend geeignet für alle industriellen 3-Phasen-Anwendungen, die eine sehr hohe Einfügungsdämpfung im Frequenzbereich zwischen 100 KHz und 30 MHz benötigen</i> |
| ■ Very high common and differential mode performance over the whole frequency range  | ■ <i>Sehr hohe asymmetrische und symmetrische Dämpfung über den gesamten Frequenzbereich</i>   |

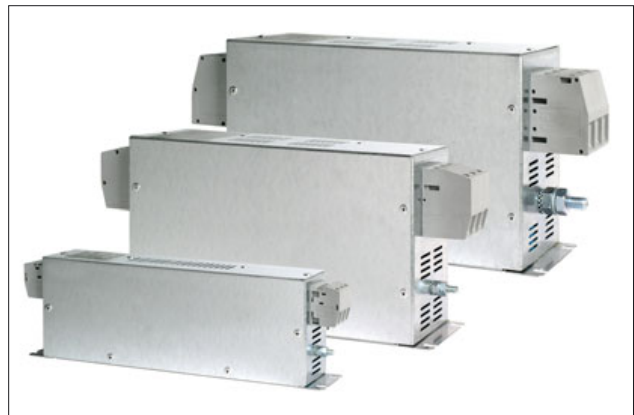

RoHS  
Ready



**Electrical Schematic / Elektrischer Schaltplan**

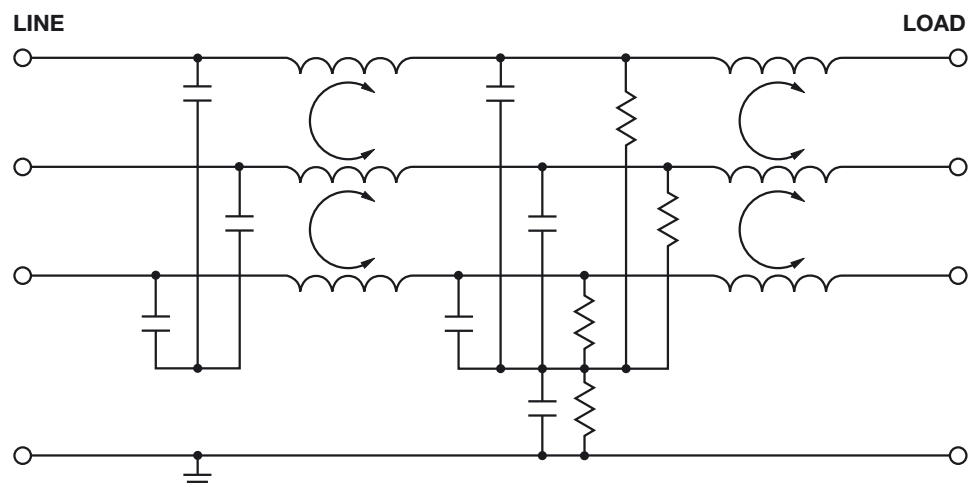

## Electrical Specifications / Elektrische Eigenschaften

**Maximum leakage current / Maximaler Ableitstrom:**

@ 400 VAC 50 Hz: 30 mA under normal circumstances  
(if 2 phases are interrupted, this leakage may rise to a significant higher level)

**Hipot rating (one minute) / Prüfspannung (1 Minute):**

line-to-ground 1850 VDC  
line-to-line 1850 VDC

**Operating frequency / Nennfrequenz:**

DC to 60 Hz

**Rated voltage (max.) / Nennspannung (max.):**

480 VAC

## Ordering Information / Bestellinformationen



Type	Order no.	Max. Current 50 °C / 40 °C	Inductance L	C <sub>x</sub>	C <sub>y</sub>
7BCF10	1609989-1	7 A / 8 A	2,44 mH	3,3 µF	2,0 µF
16BCF10	1609989-2	16 A / 18 A	2,32 mH	3,3 µF	2,0 µF
30BCF10	1609989-3	30 A / 33 A	1,61 mH	5,0 µF	2,1 µF
42BCF10	1609989-4	42 A / 46 A	1,14 mH	6,7 µF	2,2 µF
55BCF10	1609989-5	55 A / 61 A	1,80 mH	6,7 µF	2,2 µF
75BCF10	1609989-6	75 A / 83 A	1,08 mH	6,7 µF	2,2 µF
100BCF10	1609989-7	100 A / 110 A	0,82 mH	6,7 µF	2,2 µF
130BCF10	1609989-8	130 A / 143 A	0,56 mH	6,7 µF	2,2 µF
180BCF10	1609989-9	180 A / 198 A	0,72 mH	6,7 µF	2,2 µF

**Mechanical Data / Mechanische Eigenschaften**

Bottom view

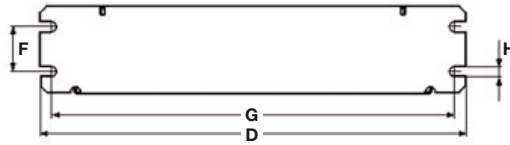

Side view

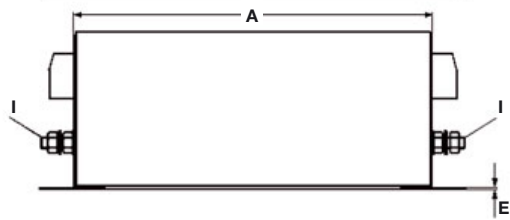

Front view

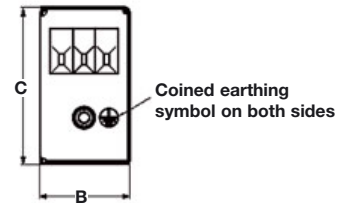

Top view

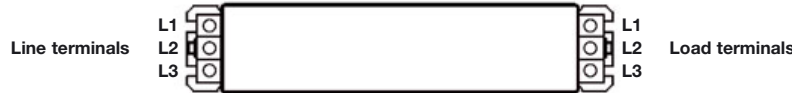

Type	A	B	C	D	E	F	G	H	GND (I)	Type of connection	Weight (kg)	Packing unit
7BCF10	160	40	70	190	0,8	20	180	4,5	M5	Terminal block 4 mm <sup>2</sup>	0,7	1
16BCF10	220	45	70	250	0,8	25	235	5,4	M5	Terminal block 4 mm <sup>2</sup>	1,1	1
30BCF10	240	50	85	270	0,8	30	255	5,4	M5	Terminal block 10 mm <sup>2</sup>	1,5	1
42BCF10	280	50	85	310	0,8	30	295	5,4	M6	Terminal block 10 mm <sup>2</sup>	1,7	1
55BCF10	220	85	90	250	1,0	60	235	5,4	M6	Terminal block 16 mm <sup>2</sup>	2,4	1
75BCF10	240	80	135	270	1,0	60	255	6,5	M6	Terminal block 25 mm <sup>2</sup>	3,2	1
100BCF10	240	90	150	270	1,0	65	255	6,5	M10	Terminal block 50 mm <sup>2</sup>	4,2	1
130BCF10	240	90	150	270	1,0	65	255	6,5	M10	Terminal block 50 mm <sup>2</sup>	4,4	1
180BCF10	350	120	170	380	1,0	102	365	6,5	M10	Terminal block 95 mm <sup>2</sup>	6,2	1

All dimensions in mm

**Typical Insertion Loss / Beispiel typischer Einfügungsdämpfung**

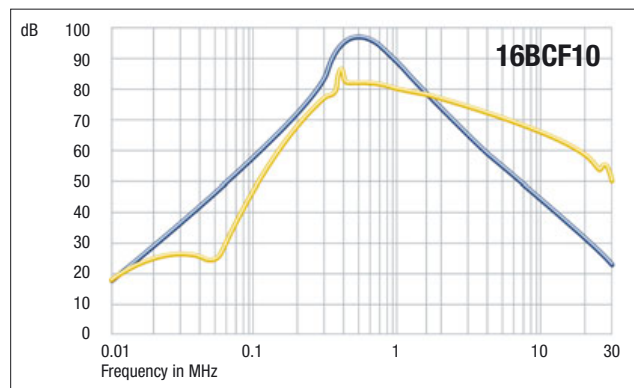
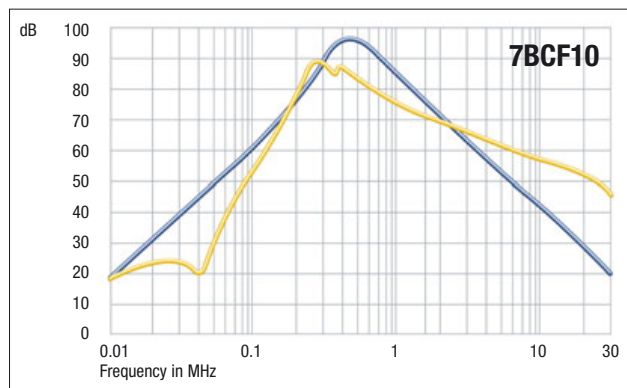

to be continued on next page/Fortsetzung auf folgender Seite

**Typical Insertion Loss / Beispiel typischer Einfügungsdämpfung**

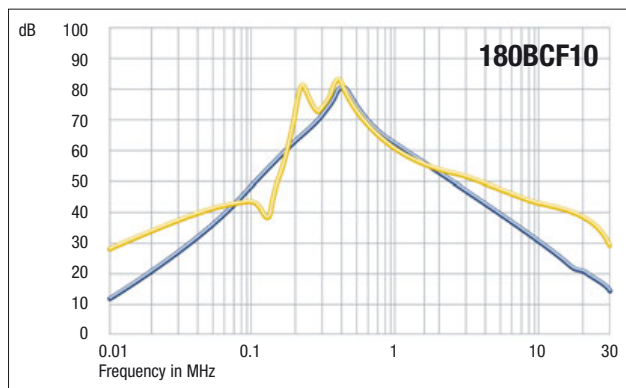
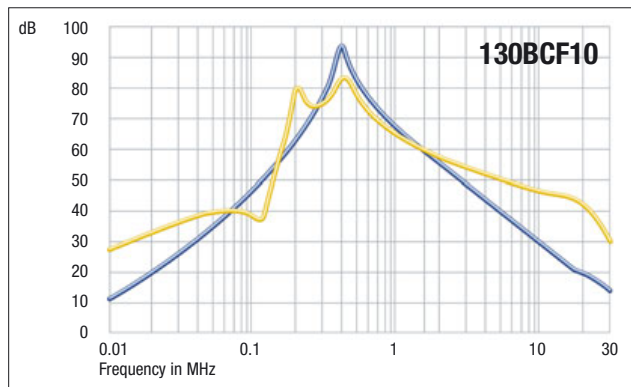
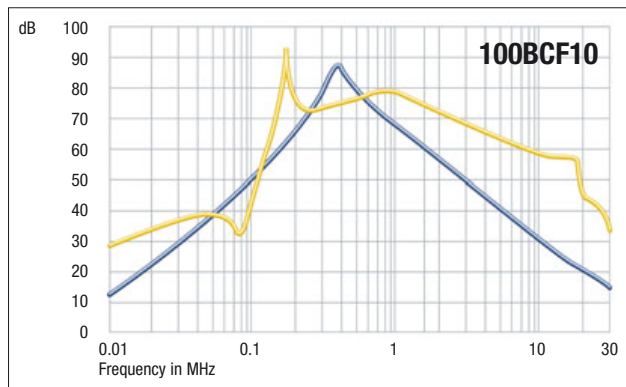
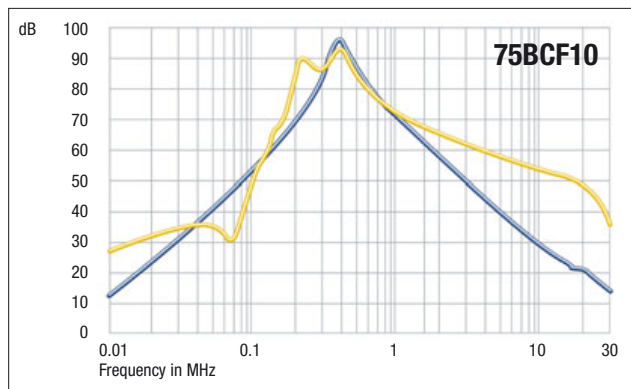
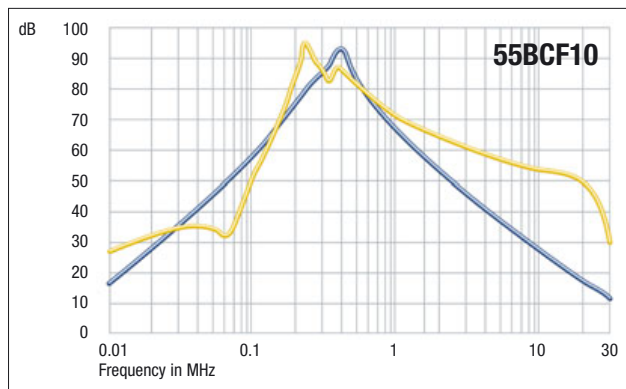
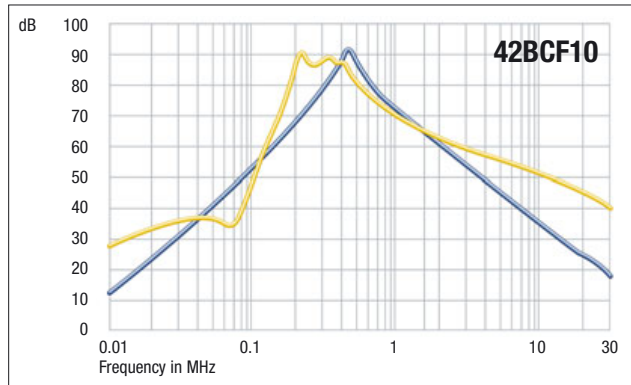
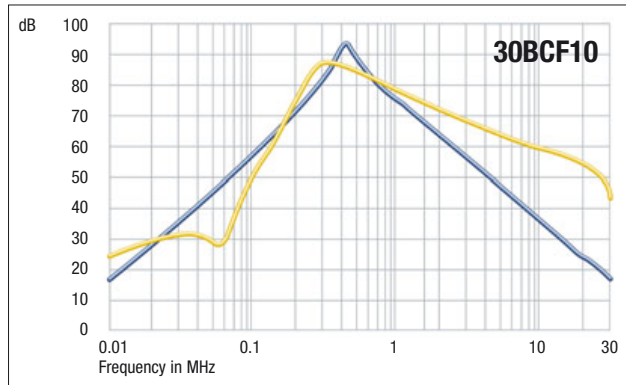

— sym.  
— asym.

Measuring method: closed 50  $\Omega$  system

**Austria** – Vienna

Phone: +43-1-905-60-0  
Fax: +43-1-905-60-1333

**Product Information Center:**

Phone: +43-1-905-60-1249  
Fax: +43-1-905-60-1251

**Belgium** – Kessel-Lo

Phone: +32-16-352-300  
Fax: +32-16-352-352

**Bulgaria** – Sofia

Phone: +359-2-971-2152  
Fax: +359-2-971-2153

**Czech Republic** – Kurim

Phone: +420-5-41-162-111  
Fax: +420-5-41-162-223

**Product Information Center:**

Phone: +420-5-41-162-113  
Fax: +420-5-41-162-132

**Denmark** – Glostrup

Phone: +45-43-480-452  
Fax: +45-43-441-414

**Egypt** – Cairo

Phone: +20-2-417-76-47  
Fax: +20-2-419-23-34

**Finland** – Helsinki

Phone: +358-95-12-34-20  
Fax: +358-95-12-34-250

**France** – Cergy-Pontoise Cedex

Phone: +33-1-3420-8888  
Fax: +33-1-3420-8600

**Product Information Center:**

Phone: +33-1-3420-8686  
Fax: +33-1-3420-8623

**France Export Divisions** –

Cergy-Pontoise Cedex  
Phone: +33-1-3420-8866  
Fax: +33-1-3420-8300

**Germany** – Bensheim**Tyco Electronics AMP GmbH**

Phone: +49-6251-133-0  
Fax: +49-6251-133-1600

**Product Information Center:**

Phone: +49-6251-133-1999  
Fax: +49-6251-133-1988

**Germany** – Langen**Tyco Electronics AMP GmbH**

Phone: +49-6103-709-0  
Fax: +49-6103-709-1223

**Germany** – Niefern**Tyco Electronics pretema GmbH & Co. KG**

Phone: +49-7233-69-0  
Fax: +49-7233-69-100

**Germany** – Ottobrunn**Tyco Electronics Raychem GmbH**

Phone: +49-89-6089-0  
Fax: +49-89-6096-345

**Great Britain** –

Stanmore Middlesex  
Phone: +44-8706-080-208  
Fax: +44-208-954-6234

**Product Information Center:**

Freephone GB: 0800-267-666  
Phone: +44-208-420-8341  
+44-208-420-8343  
Fax: +44-208-420-8081

**Greece** – Athens

Phone: +30-210-9370-396/397  
Fax: +30-210-9370-655

**Hungary** – Budapest

Phone: +36-1-289-1000  
Fax: +36-1-289-1010

**Product Information Center:**

Phone: +36-1-289-1016  
Fax: +36-1-289-1017

**Ireland** – Dublin

Phone: +353-1-820-3000  
Fax: +353-1-820-9790

**Israel** – Yokneam

Phone: +972-4-959-0508  
Fax: +972-4-959-0506

**Italy** – Collegno (Torino)

Phone: +39-011-4012-111  
Fax: +39-011-4031116

**Product Information Center:**

Phone: +39-011-4012-360  
Fax: +39-011-40287360

**Lithuania** – Vilnius

Phone: +370-5-2131-402  
Fax: +370-5-2131-403

**Netherlands** – 's-Hertogenbosch

Phone: +31-73-6246-246  
Fax: +31-73-6212-365

**Product Information Center:**

Phone: +31-73-6246-999  
Fax: +31-73-6246-998

**Norway** – Nesbru

Phone: +47-66-77-88-86  
Fax: +47-66-77-88-55

**Poland** – Warsaw

Phone: +48-22-4576-700  
Fax: +48-22-4576-720

**Product Information Center:**

Phone: +48-22-4576-704  
Fax: +48-22-4576-720

**Romania** – Bucharest

Phone: +40-21-311-3479 + 3596  
Fax: +40-21-312-0574

**Russia** – Moscow

Phone: +7-095-926-55-06...09  
Fax: +7-095-926-55-05

**Russia** – St. Petersburg

Phone: +7-812-718-8192  
Fax: +7-812-718-8193

**Slovenia** – Ljubljana

Phone: +386-1561-3270  
Fax: +386-1561-3240

**South Africa** – Port Elizabeth

Phone: +2741-503-4500  
Fax: +2741-581-0440

**Spain** – Barcelona

Phone: +34-93-291-0330  
Fax: +34-93-201-7879

**Sweden** – Upplands Väsby

Phone: +46-8-50-72-50-00  
Fax: +46-8-50-72-50-01

**Switzerland** – Steinach

Phone: +41-71-447-0447  
Fax: +41-71-447-0444

**Turkey** – Istanbul

Phone: +90-212-281-8181...3  
+90-212-282-5130/5430  
Fax: +90-212-281-8184

**Ukraine** – Kiev

Phone: +380-44-206-2265  
Fax: +380-44-206-2264