

Inlet filter, front- or rear side mounting, protection class I or II

Standard- or Medical-Filter



Front or rear mounting
Protection class I

Rear mounting with
integrated thread
Protection class I

Front or rear mounting
Protection class II

C14



70° C

C18



70° C



Description

- Panel Mount:
 - Screw-on version from front or rear side
- 2 Functions:
 - Inlet, protection class I or II, Line filter in standard and medical version
 - Quick connect terminals 6.3 x 0.8 mm

Approvals

- VDE License Number: 40016382
- UL License Number: E72928

Characteristics

- Compact high performance filter
- Qualified for use in equipment according IEC/EN 60950

Other versions on request

- Class X1 capacitor for enhanced surge withstand voltage
- Medical version M80

Weblinks

Approvals: <http://www.schurter.com/approvals>
RoHS: <http://www.schurter.com/rohs>

Technical Data

Ratings IEC	1 - 10 A @ Ta 40 °C / 250 VAC; 50 Hz
Ratings UL/CSA	1 - 15 A @ Ta 40 °C / 250 VAC; 60 Hz
Leakage Current	standard < 0.5 mA (250 V / 60 Hz) medical < 5 µA (250 V / 60 Hz)
Dielectric Strength	> 1.7 kVDC between L-N > 2.7 kVDC between L/N-PE Test voltage (2 sec)
Allowable Operation Temp.	-25 °C to 85 °C
Climatic Category	25/085/21 acc. to, IEC 60068-1
Degree of Protection	from front side IP 40 acc. to IEC 60529
Protection Class	Suitable for appliances with protection class I or II acc. to IEC 61140
Terminal	Quick connect terminals 6.3 x 0.8 mm
Panel Thickness s	Screw-on from rear side to 2.5 mm Mounting screw torque max 0.5 Nm
Material: Housing	Thermoplastic, black, UL 94V-0

Appliance-Inlet /-Outlet	C14/C18 acc. to IEC/EN 60320-1, UL 498, CSA C22.2 no. 42 (for cold condition) pin-temperature 70 °C, 10 A, Protection class I or II
Line Filter	Standard and Medical Version, IEC 60939, IEC 60601-1, UL 1283, UL 544, EN 133 200, CSA C22.2 no. 8 Technical details
MTBF	> 3'000'000 h acc. to MIL-HB-217 F

Dimensions

Length 54.5 mm

Front or rear side mounting for screws with nuts or blind rivets (panel cutout for frontside mounting)

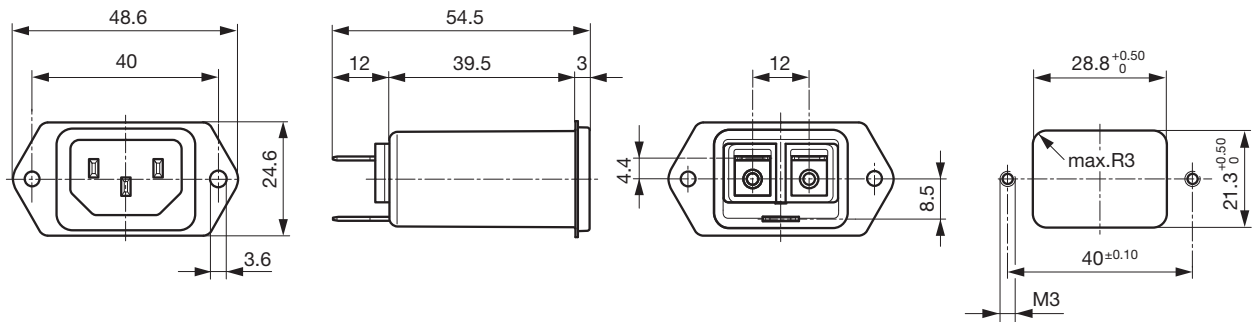

Dimensions for class I version also apply to class II

Rear side mounting with pre-formed, threaded holes for M3 screws (panel cutout for rear side mounting)

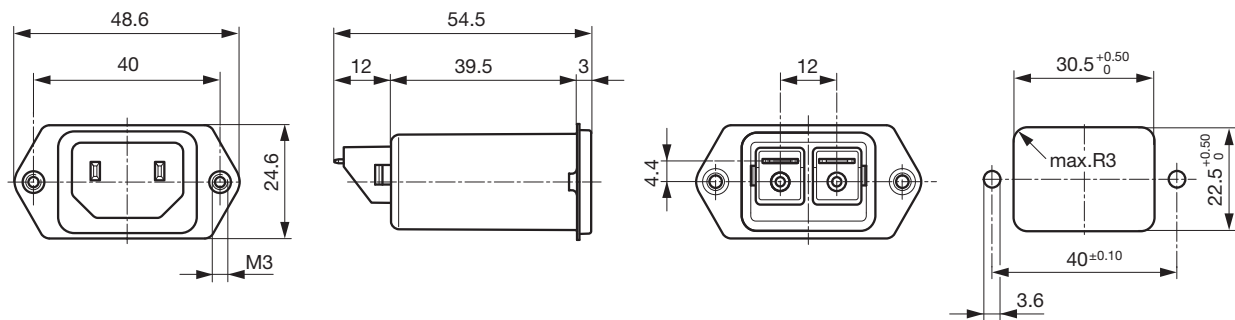

Dimensions for class II version also apply to class I

Technical Data of Filter-Components

Rated Current [A]	Filter-Type	Inductances L [mH]	Capacitance CX [nF]	Capacitance CY [nF]	R [MΩ]
1	Standard Version	2 x 12	100	2.2	-
2	Standard Version	2 x 5.2	100	2.2	-
4	Standard Version	2 x 2	100	2.2	-
6	Standard Version	2 x 0.8	100	2.2	-
10	Standard Version	2 x 0.4	100	2.2	-
15	Standard Version	2 x 0.1	100	2.2	-
1	Bleed Resistor Version	2 x 12	100	2.2	1
2	Bleed Resistor Version	2 x 5.2	100	2.2	1
4	Bleed Resistor Version	2 x 2	100	2.2	1
6	Bleed Resistor Version	2 x 0.8	100	2.2	1
10	Bleed Resistor Version	2 x 0.4	100	2.2	1
15	Bleed Resistor Version	2 x 0.1	100	2.2	1
1	Medical Version (M5)	2 x 12	100	-	1
2	Medical Version (M5)	2 x 5.2	100	-	1
4	Medical Version (M5)	2 x 2	100	-	1
6	Medical Version (M5)	2 x 0.8	100	-	1
10	Medical Version (M5)	2 x 0.4	100	-	1
15	Medical Version (M5)	2 x 0.1	100	-	1

Diagrams

Standard version

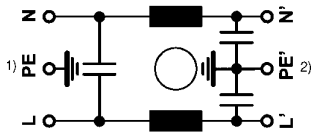

1) Line
2) Load

Bleed resistor version

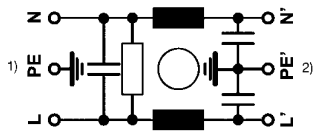

1) Line
2) Load

Medical version M5

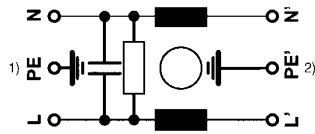

1) Line
2) Load

Medical version M5, prot. class II

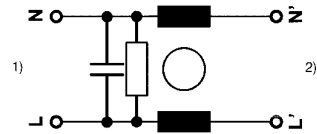

Attenuation loss

--- differential mode ____ common mode

Standard version

1 A

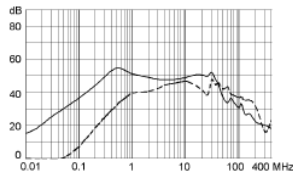

2 A

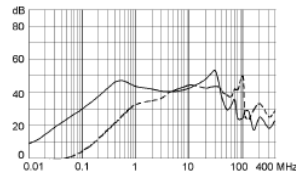

4 A

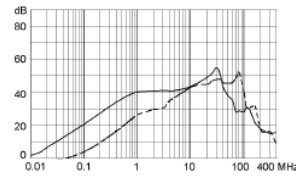

6 A

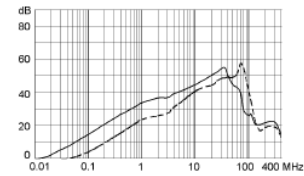

10 A

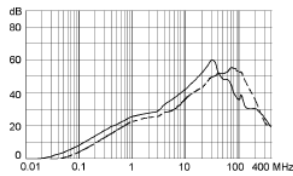

15 A

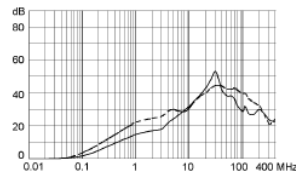

Medical version (M5)

1 A

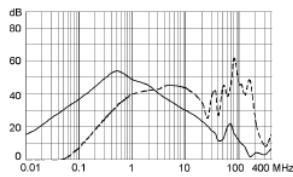

2 A

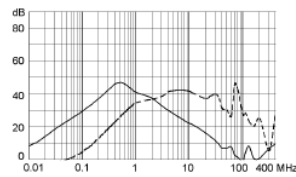

4 A

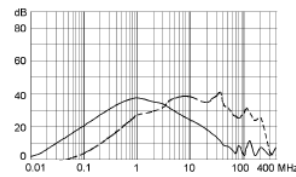

6 A

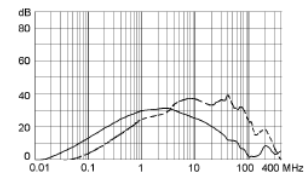

10 A

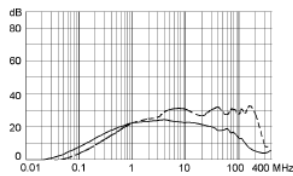

15 A

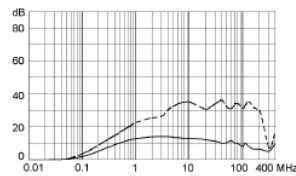

Variants

Rated Current [A]	Filter-Type	Screw-on version from front or rear for screws with nuts, or rivets	Screw-on version from rear with pre-formed, threaded holes for M3 screws	Protection Class	Order Number
1	Standard Version		●	I	5120.1000.0
2	Standard Version		●	I	5120.1001.0
4	Standard Version		●	I	5120.1003.0
6	Standard Version		●	I	5120.1004.0
10	Standard Version		●	I	5120.1006.0
15	Standard Version		●	I	5120.1007.0
1	Standard Version	●		I	5120.0000.0
2	Standard Version	●		I	5120.0001.0
4	Standard Version	●		I	5120.0003.0
6	Standard Version	●		I	5120.0004.0
10	Standard Version	●		I	5120.0006.0
15	Standard Version	●		I	5120.0007.0
1	Bleed Resistor Version			I	5120.0200.0
2	Bleed Resistor Version			I	5120.0201.0
4	Bleed Resistor Version			I	5120.0203.0
6	Bleed Resistor Version			I	5120.0204.0
10	Bleed Resistor Version			I	5120.0206.0
15	Bleed Resistor Version			I	5120.0207.0
1	Bleed Resistor Version	●		I	5120.1200.0
2	Bleed Resistor Version	●		I	5120.1201.0
4	Bleed Resistor Version	●		I	5120.1203.0
6	Bleed Resistor Version	●		I	5120.1204.0
10	Bleed Resistor Version	●		I	5120.1206.0
15	Bleed Resistor Version	●		I	5120.1207.0
1	Medical Version (M5)		●	I	5120.1300.0
2	Medical Version (M5)		●	I	5120.1301.0
4	Medical Version (M5)		●	I	5120.1303.0
6	Medical Version (M5)		●	I	5120.1304.0
10	Medical Version (M5)		●	I	5120.1306.0
15	Medical Version (M5)		●	I	5120.1307.0
1	Medical Version (M5)	●		I	5120.0300.0
2	Medical Version (M5)	●		I	5120.0301.0
4	Medical Version (M5)	●		I	5120.0303.0
6	Medical Version (M5)	●		I	5120.0304.0
10	Medical Version (M5)	●		I	5120.0306.0
15	Medical Version (M5)	●		I	5120.0307.0
1	Medical Version (M5)		●	II	5120.1300.1
2	Medical Version (M5)		●	II	5120.1301.1
6	Medical Version (M5)		●	II	5120.1304.1
10	Medical Version (M5)		●	II	5120.1306.1
2	Medical Version (M5)	●		II	5120.0301.1
4	Medical Version (M5)	●		II	5120.0303.1
6	Medical Version (M5)	●		II	5120.0304.1
4	Medical Version (M5)	●		II	5120.1303.1

15 A version only according UL/CSA

Packaging unit 10 Pcs

Accessory

Description

Assorted Covers



Cord retaining kits