

Spezifikation für Freigabe / specification for release

Kunde / customer :

Artikelnummer / part number : **744233670**



Bezeichnung / description : **SMD Stromkompensierter Datenleitungsfilter WE-CNSW HF**
SMD common mode noise suppressor WE-CNSW HF

DATUM / DATE : 2010-10-01

A Mechanische Abmessungen / dimensions:

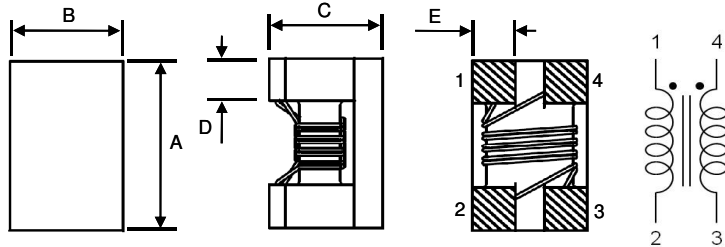

	0805	
A	2,00 ± 0,2	mm
B	1,20 ± 0,2	mm
C	1,20 ± 0,2	mm
D	0,50 ref.	mm
E	0,45 ref.	mm

B Elektrische Eigenschaften / electrical properties:

Eigenschaften / properties	Testbedingungen / test conditions		Wert / value	Einheit / unit	tol.
Impedanz / impedance	100 MHz	Z	67	Ω	± 25 %
Nennspannung / rated voltage		U _{DC}	50	V	max.
DC-Widerstand / DC-resistance	@ 20 °C	R _{DC}	240	mΩ	max.
Nennstrom / rated current	ΔT= 40 K	I _{DC}	320	mA	max.

C Lötpad / soldering spec.:

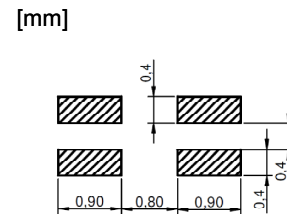

D Prüfgeräte / test equipment:

Agilent E4991A für/for Z
GMC Metrahit 271 für/for R_{DC} und/and I_{DC}
Agilent 6032A für/for I_{DC}

E Testbedingungen / test conditions:

Luftfeuchtigkeit / humidity: 33 %
 Umgebungstemperatur / temperature: +20 °C

F Werkstoffe & Zulassungen / material & approvals:

Basismaterial / base material: Ferrit / Ferrite

G Eigenschaften / general specifications:

Umgebungstemperatur / ambient temperature: -40 °C - +85 °C
 Betriebstemperatur / operating temperature: -40 °C - +125 °C
 It is recommended that the temperature of the part does not exceed 125 °C under worst case operating conditions.

Freigabe erteilt / general release:	Kunde / customer			
Datum / date	Unterschrift / signature			
	Würth Elektronik			
Geprüft / checked	Kontrolliert / approved		SBa	Version 1
			Name	Änderung / modification
				Datum / date

Würth Elektronik eiSos GmbH & Co. KG

D-74638 Waldenburg · Max-Eyth-Strasse 1 -3 · Germany · Telefon (+49) (0) 7942 - 945 - 0 · Telefax (+49) (0) 7942 - 945 - 400
<http://www.we-online.com>

Spezifikation für Freigabe / specification for release

Kunde / customer :

Artikelnummer / part number : **744233670**



Bezeichnung / **SMD Stromkompensierter Datenleitungsfilter WE-CNSW HF**
 description : **SMD common mode noise suppressor WE-CNSW HF**

WÜRTH ELEKTRONIK

DATUM / DATE : 2010-10-01

H Impedanzverlauf / impedance curve:

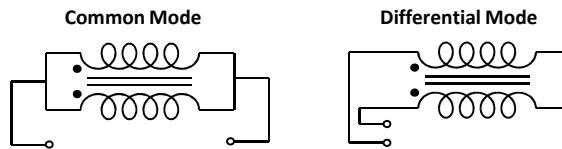
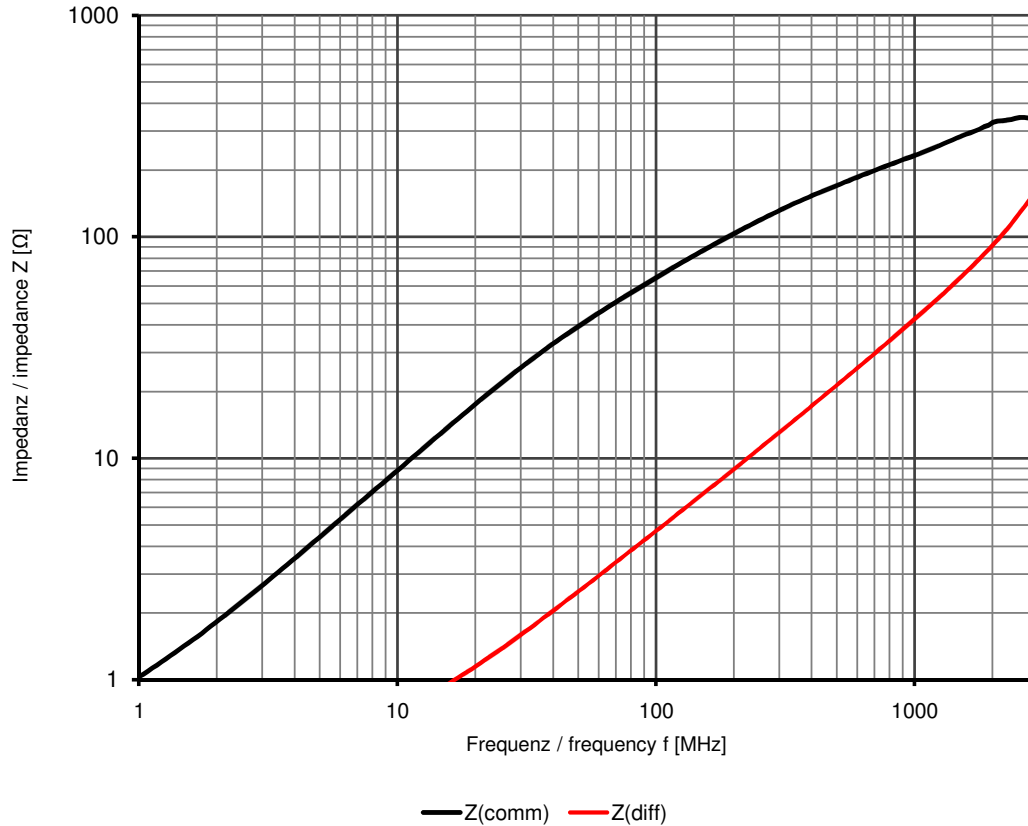

Freigabe erteilt / general release:	Kunde / customer			
.....			
Datum / date	Unterschrift / signature			
.....	Würth Elektronik			
.....	SBa	Version 1	2010-10-01
Geprüft / checked	Kontrolliert / approved	Name	Änderung / modification	Datum / date

Würth Elektronik eiSos GmbH & Co. KG

D-74638 Waldenburg · Max-Eyth-Strasse 1 -3 · Germany · Telefon (+49) (0) 7942 - 945 - 0 · Telefax (+49) (0) 7942 - 945 - 400
<http://www.we-online.com>

Spezifikation für Freigabe / specification for release

Kunde / customer :
 Artikelnummer / part number : **744233670**
 Bezeichnung / description : **SMD Stromkompensierter Datenleitungsfilter WE-CNSW HF**
SMD common mode noise suppressor WE-CNSW HF



DATUM / DATE : 2010-10-01

I Rollenspezifikation / tape and reel specifications:

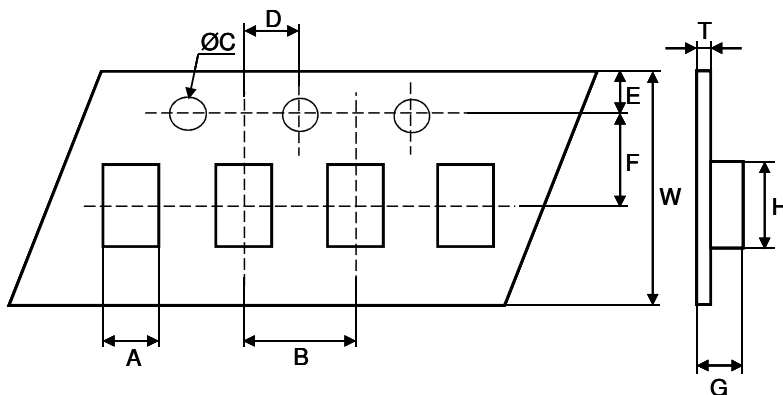

Gurtspezifikation / Tape specification:		
A	1,55 ± 0,2	mm
B	4,00 ± 0,1	mm
C	1,50 + 0,1	mm
D	2,00 ± 0,05	mm
E	1,75 ± 0,1	mm
F	3,50 ± 0,05	mm
G	1,55 max.	mm
H	2,25 ± 0,2	mm
T	0,30 max.	mm
W	8,00 ± 0,3	mm

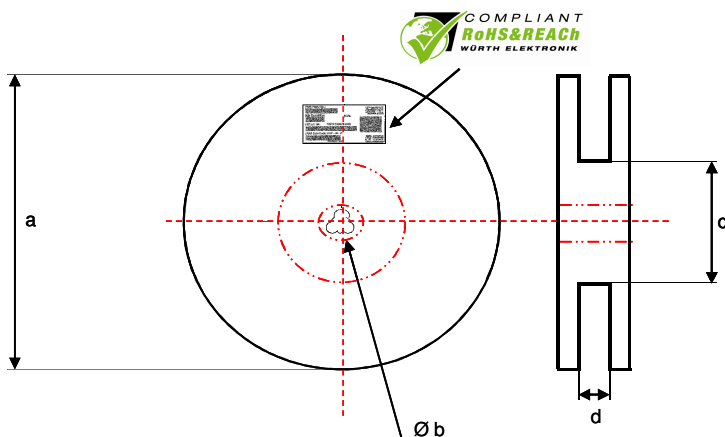

Rollenspezifikation / Reel Specification:		
a	178,0 ± 2,0	mm
b	20,20 min.	mm
c	58,00 ± 2,0	mm
d	9,00 ± 1,5	mm

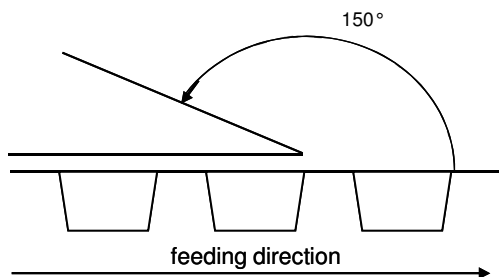

The force of tearing off cover tape is 0,1 to 0,7 N in arrow direction.

Freigabe erteilt / general release:	Kunde / customer		
Datum / date	Unterschrift / signature		
	Würth Elektronik		
Geprüft / checked	Kontrolliert / approved	SBa	Version 1
		Name	Änderung / modification
			Datum / date

This electronic component has been designed and developed for usage in general electronic equipment. Before incorporating this component into any equipment where higher safety and reliability is especially required or if there is the possibility of direct damage or injury to human body, for example in the range of aerospace, aviation, nuclear control, submarine, transportation, (automotive control, train control, ship control), transportation signal, disaster prevention, medical, public information network etc, Würth Elektronik eiSos GmbH must be informed before the design-in stage. In addition, sufficient reliability evaluation checks for safety must be performed on every electronic component which is used in electrical circuits that require high safety and reliability functions or performance.

Würth Elektronik eiSos GmbH & Co. KG

D-74638 Waldenburg · Max-Eyth-Strasse 1 -3 · Germany · Telefon (+49) (0) 7942 - 945 - 0 · Telefax (+49) (0) 7942 - 945 - 400
<http://www.we-online.com>