



ALL RIGHTS RESERVED. NO PORTION OF THIS PUBLICATION, WHETHER IN WHOLE OR IN PART CAN BE REPRODUCED WITHOUT THE EXPRESS WRITTEN CONSENT OF SPC TECHNOLOGY.

SPC-F005.DWG

REVISIONS

DCP #	REV	DESCRIPTION	DRAWN	DATE	CHECKD	DATE	APPRVD	DATE
1891	A	RELEASED	EO	5/1/06	SA	7/25/06	HO	7/25/06

DOC. NO. SPC-F005 * Effective: 7/8/02 * DCP No: 1398



RoHS Compliant

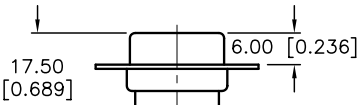
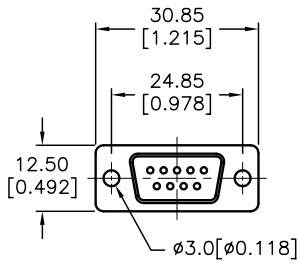

DB9(F)

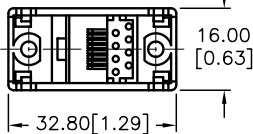
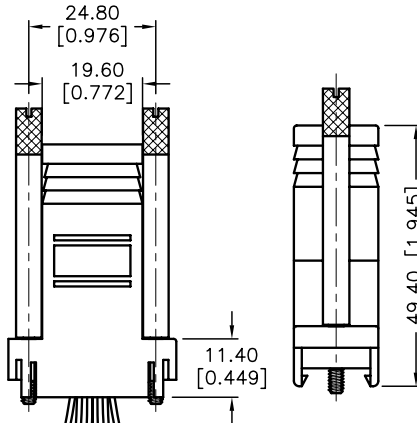
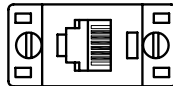
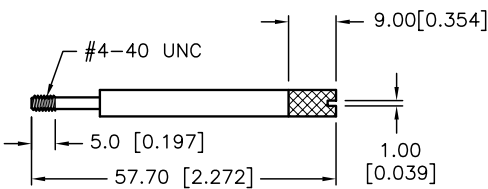

FRONT VIEW OF 6P6C TELEPHONE JACK

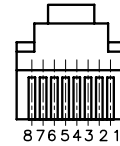

Wire System	
1	-
2	White
3	Black
4	Red
5	Green
6	Yellow
7	Blue
8	-

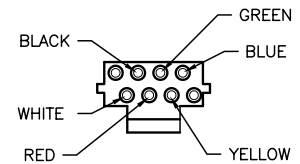

SPECIFICATION:

- D-Sub Connector: Tin-Plated Shell with Black Color Insulator
- Contact:
 - D-Sub: Brass, Gold-Plated
 - RJ12: Brass, Gold-Plated
- Body: ABS, Ivory (Beige) color
- Thumb Screw: Steel, Nickel-plated
- Electronic Wire: UL1061, 26AWG

DISCLAIMER: ALL STATEMENTS AND TECHNICAL INFORMATION CONTAINED HEREIN ARE BASED UPON INFORMATION AND/OR TESTS WE BELIEVE TO BE ACCURATE AND RELIABLE. SINCE CONDITIONS OF USE ARE BEYOND OUR CONTROL, THE USER SHALL DETERMINE THE SUITABILITY OF THE PRODUCT FOR THE INTENDED USE AND ASSUME ALL RISK AND LIABILITY WHATSOEVER IN CONNECTION THEREWITH.

TOLERANCES:
Unless Otherwise Specified, Fractions Decimals Angles
.x ±0.20
.xx ±0.12

DRAWN BY:	DATE:
EKLAS ODISH	5/1/06
CHECKED BY:	DATE:
SAMI ALNADI	7/25/06
APPROVED BY:	DATE:
HISHAM ODISH	7/25/06

DRAWING TITLE: Telephone Adapter, DB9 Female to RJ12, 6 Conductors

SIZE	DWG. NO.	ELECTRONIC FILE	REV
A	SPC19787	84K8551.DWG	A
SCALE:	NTS	U.O.M.: [mm] INCHES	SHEET: 1 OF 1