

Foreword

AVX offers a broad line of solid Tantalum capacitors in a wide range of sizes, styles, and ratings to meet any design needs. This catalog combines into one source AVX's leaded tantalum capacitor information from its worldwide tantalum operations.

The TAP is rated for use from -55°C to $+85^{\circ}\text{C}$ at rated voltage and up to $+125^{\circ}\text{C}$ with voltage derating. There are three preferred wire forms to choose from which are available on tape and reel, and in bulk for hand insertion.

Four sizes of molded axials, the TAR series, are also available. The TAR is fully marked and available on tape and reel for high speed insertion. The TAA is a hermetically sealed series also with four case sizes available.

AVX has a complete tantalum applications service available for use by all our customers. With the capability to prototype and mass produce solid tantalum capacitors in special configurations, almost any design need can be fulfilled. And if the customer requirements are outside our standard testing, AVX will work with you to define and implement a test or screening plan.

AVX is determined to become the world leader in tantalum capacitor technology and has made, and is continuing to make, significant investments in equipment and research to reach that end. We believe that the investment has paid off with the devices shown on the following pages.

Dipped Radial Capacitors

SOLID TANTALUM RESIN DIPPED SERIES TAP

The TAP resin dipped series of miniature tantalum capacitors is available for individual needs in both commercial and professional applications. From computers to automotive to industrial, AVX has a dipped radial for almost any application.

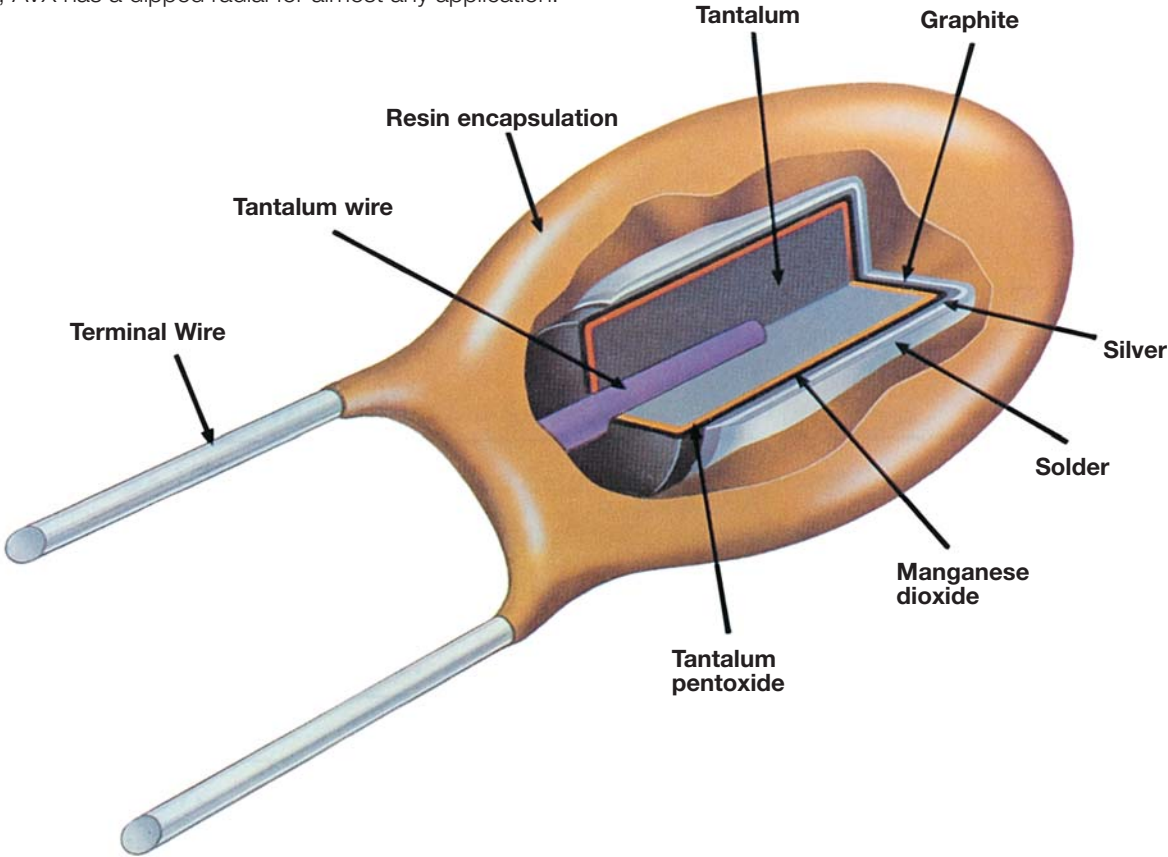

Dipped Radial Capacitors



Wire Form Outline

SOLID TANTALUM RESIN DIPPED TAP

Preferred Wire Forms

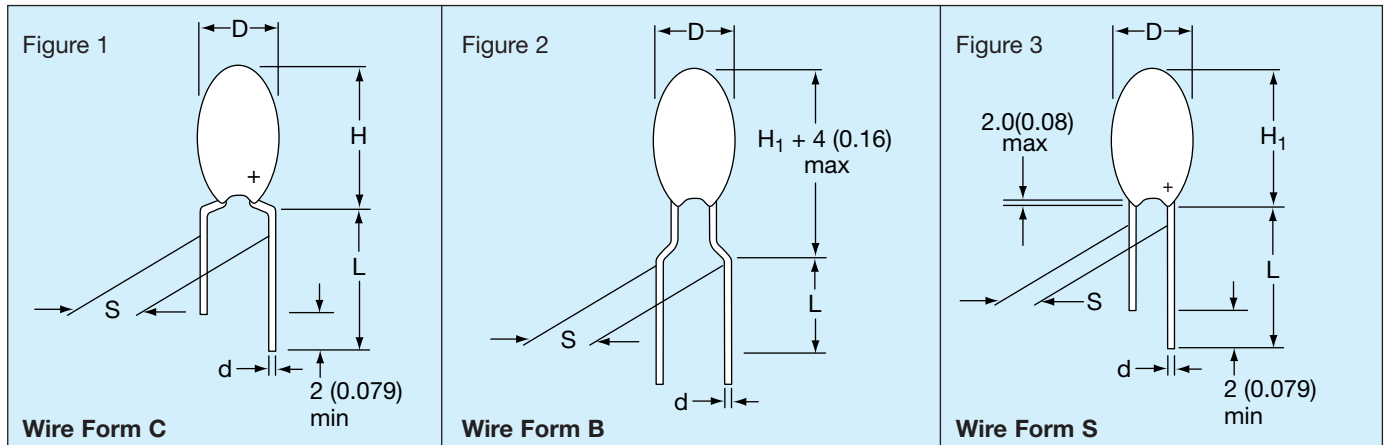

Non-Preferred Wire Forms (Not recommended for new designs)

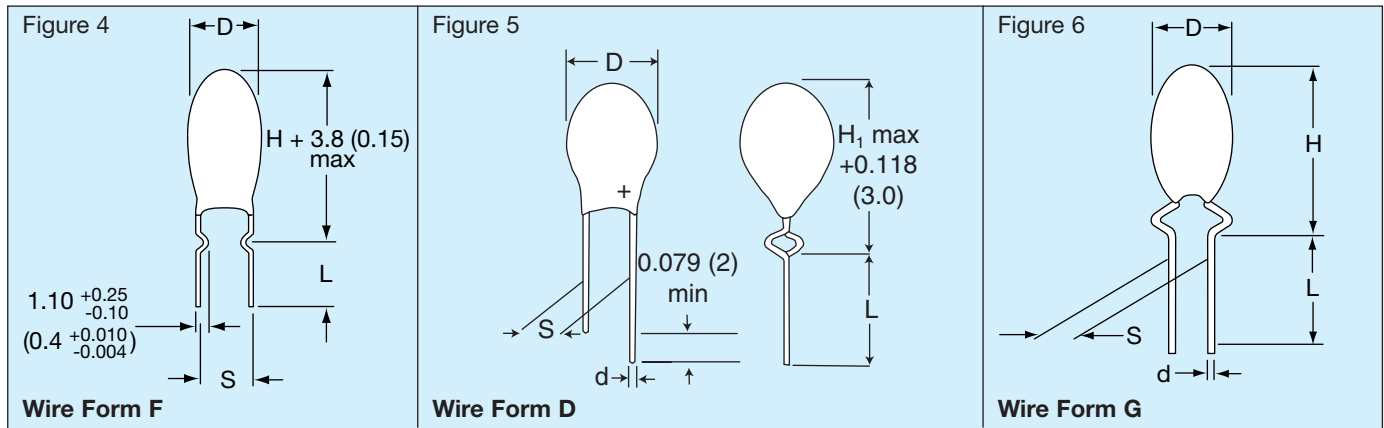

DIMENSIONS

Wire Form	Figure	Case Size	L (see note 1)	S	d	Packaging Suffixes Available*
-----------	--------	-----------	----------------	---	---	-------------------------------

Preferred Wire Forms

C	Figure 1	A - R*	16.0±4.00 (0.630±0.160)	5.00±1.00 (0.200±0.040)	0.50±0.05 (0.020±0.002)	CCS Bulk CRW Tape/Reel CRS Tape/Ammo
B	Figure 2	A - J*	16.0±4.00 (0.630±0.160)	5.00±1.00 (0.200±0.040)	0.50±0.05 (0.020±0.002)	BRW Tape/Reel BRS Tape/Ammo
S	Figure 3	A - J*	16.0±4.00 (0.630±0.160)	2.50±0.50 (0.100±0.020)	0.50±0.05 (0.020±0.002)	SCS Bulk SRW Tape/Reel SRS Tape/Ammo

Non-Preferred Wire Forms (Not recommended for new designs)

F	Figure 4	A - R	3.90±0.75 (0.155±0.030)	5.00±0.50 (0.200±0.020)	0.50±0.05 (0.020±0.002)	FCS Bulk
D	Figure 5	A - H*	16.0±4.00 (0.630±0.160)	2.50±0.75 (0.100±0.020)	0.50±0.05 (0.020±0.002)	DCS Bulk DTW Tape/Reel DTS Tape/Ammo
G	Figure 6	A - J	16.0±4.00 (0.630±0.160)	3.18±0.50 (0.125±0.020)	0.50±0.05 (0.020±0.002)	GSB Bulk
H	Similar to Figure 1	A - R	16.0±4.00 (0.630±0.160)	6.35±1.00 (0.250±0.040)	0.50±0.05 (0.020±0.002)	HSB Bulk

Notes: (1) Lead lengths can be supplied to tolerances other than those above and should be specified in the ordering information.

(2) For D, H, and H₁ dimensions, refer to individual product on following pages.

* For case size availability in tape and reel, please refer to pages 133-134.



Dipped Radial Capacitors



TAP Series

SOLID TANTALUM RESIN DIPPED CAPACITORS

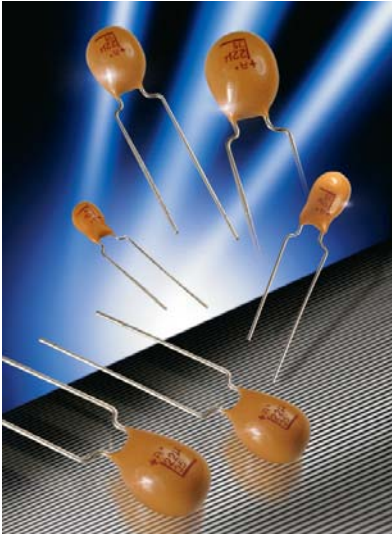

TAP is a professional grade device manufactured with a flame retardant coating and featuring low leakage current and impedance, very small physical sizes and exceptional temperature stability. It is designed and conditioned to operate to +125°C (see page 165 for voltage derating above 85°C) and is available loose or taped and reeled for auto insertion. The 15 case sizes with wide capacitance and working voltage ranges means the TAP can accommodate almost any application.

MAXIMUM CASE DIMENSIONS: millimeters (inches)

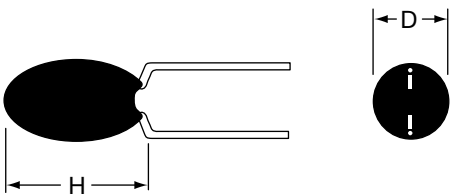

Wire Case	C, F, G, H H	B, S, D *H ₁	D
A	8.50 (0.330)	7.00 (0.280)	4.50 (0.180)
B	9.00 (0.350)	7.50 (0.300)	4.50 (0.180)
C	10.0 (0.390)	8.50 (0.330)	5.00 (0.200)
D	10.5 (0.410)	9.00 (0.350)	5.00 (0.200)
E	10.5 (0.410)	9.00 (0.350)	5.50 (0.220)
F	11.5 (0.450)	10.0 (0.390)	6.00 (0.240)
G	11.5 (0.450)	10.0 (0.390)	6.50 (0.260)
H	12.0 (0.470)	10.5 (0.410)	7.00 (0.280)
J	13.0 (0.510)	11.5 (0.450)	8.00 (0.310)
K	14.0 (0.550)	12.5 (0.490)	8.50 (0.330)
L	14.0 (0.550)	12.5 (0.490)	9.00 (0.350)
M	14.5 (0.570)	13.0 (0.510)	9.00 (0.350)
N	16.0 (0.630)		9.00 (0.350)
P	17.0 (0.670)		10.0 (0.390)
R	18.5 (0.730)		10.0 (0.390)

HOW TO ORDER

TAP

Type

475

Capacitance Code
pF code: 1st two digits represent significant figures, 3rd digit represents multiplier (number of zeros to follow)

M

Capacitance Tolerance
K = ±10%
M = ±20%
(For J = ±5% tolerance, please consult factory)

035

Rated DC Voltage

SCS

Suffix indicating wire form and packaging (see page 129)

Dipped Radial Capacitors



TAP Series

TECHNICAL SPECIFICATIONS

Technical Data:		All technical data relate to an ambient temperature of +25°C							
Capacitance Range:		0.1 µF to 330 µF							
Capacitance Tolerance:		±20%; ±10% (±5% consult your AVX representative for details)							
Rated Voltage DC (V _R)	≤+85°C:	6.3	10	16	20	25	35	50	
Category Voltage (V _C)	≤+125°C:	4	6.3	10	13	16	23	33	
Surge Voltage (V _S)	≤+85°C:	8	13	20	26	33	46	65	
	≤+125°C:	5	9	12	16	21	28	40	
Temperature Range:		-55°C to +125°C							
Environmental Classification:		55/125/56 (IEC 68-2)							
Dissipation Factor:		≤0.04 for C _R 0.1-1.5µF ≤0.06 for C _R 2.2-6.8µF ≤0.08 for C _R 10-68µF ≤0.10 for C _R 100-330µF							
Reliability:		1% per 1000 hrs. at 85°C with 0.1Ω/V series impedance, 60% confidence level.							
Qualification:		CECC 30201 - 032							

Capacitance Range (letter denotes case size)								
Capacitance		Rated voltage DC (V _R)						
µF	Code	6.3V	10V	16V	20V	25V	35V	50V
0.1	104						A	A
0.15	154						A	A
0.22	224						A	A
0.33	334						A	A
0.47	474						A	A
0.68	684						A	B
1.0	105				A	A	A	C
1.5	155			A	A	A	A	D
2.2	225		A	A	A	A	B	E
3.3	335	A	A	A	B	B	C	F
4.7	475	A	A	B	C	C	E	G
6.8	685	A	B	C	D	D	F	H
10	106	B	C	D	E	E	F	J
15	156	C	D	E	F	F	H	K
22	226	D	E	F	H	H	K	L
33	336	E	F	F	J	J	M	
47	476	F	G	J	K	M	N	
68	686	G	H	L	N	N		
100	107	H	K	N	N			
150	157	K	N	N				
220	227	M	P	R				
330	337	P	R					

Values outside this standard range may be available on request.
 AVX reserves the right to supply capacitors to a higher voltage rating, in the same case size, than that ordered.

MARKING

Polarity, capacitance, rated DC voltage, and an "A" (AVX logo) are laser marked on the capacitor body which is made of flame retardant gold epoxy resin with a limiting oxygen index in excess of 30 (ASTM-D-2863).

- Polarity
- Capacitance
- Voltage
- AVX logo
- Tolerance code:
 - ±20% = Standard (no marking)
 - ±10% = "K" on reverse side of unit
 - ±5% = "J" on reverse side of unit

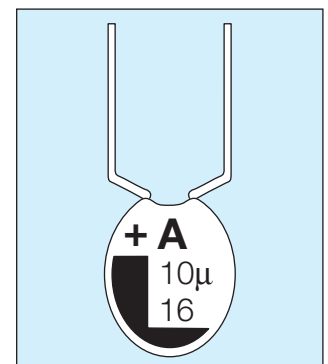

Dipped Radial Capacitors



TAP Series

RATINGS AND PART NUMBER REFERENCE

AVX Part No.	Case Size	Capacitance μF	DCL (μA) Max.	DF % Max.	ESR Max. (Ω) @ 100 kHz
6.3 volt @ 85°C (4 volt @ 125°C)					
TAP 335(+006)	A	3.3	0.5	6	13.0
TAP 475(+006)	A	4.7	0.5	6	10.0
TAP 685(+006)	A	6.8	0.5	6	8.0
TAP 106(+006)	B	10	0.5	8	6.0
TAP 156(+006)	C	15	0.8	8	5.0
TAP 226(+006)	D	22	1.1	8	3.7
TAP 336(+006)	E	33	1.7	8	3.0
TAP 476(+006)	F	47	2.4	8	2.0
TAP 686(+006)	G	68	3.4	8	1.8
TAP 107(+006)	H	100	5.0	10	1.6
TAP 157(+006)	K	150	7.6	10	0.9
TAP 227(+006)	M	220	11.0	10	0.9
TAP 337(+006)	P	330	16.6	10	0.7
10 volt @ 85°C (6.3 volt @ 125°C)					
TAP 225(+010)	A	2.2	0.5	6	13.0
TAP 335(+010)	A	3.3	0.5	6	10.0
TAP 475(+010)	A	4.7	0.5	6	8.0
TAP 685(+010)	B	6.8	0.5	6	6.0
TAP 106(+010)	C	10	0.8	8	5.0
TAP 156(+010)	D	15	1.2	8	3.7
TAP 226(+010)	E	22	1.7	8	2.7
TAP 336(+010)	F	33	2.6	8	2.1
TAP 476(+010)	G	47	3.7	8	1.7
TAP 686(+010)	H	68	5.4	8	1.3
TAP 107(+010)	K	100	8.0	10	1.0
TAP 157(+010)	N	150	12.0	10	0.8
TAP 227(+010)	P	220	17.6	10	0.6
TAP 337(+010)	R	330	20.0	10	0.5
16 volt @ 85°C (10 volt @ 125°C)					
TAP 155(+016)	A	1.5	0.5	4	10.0
TAP 225(+016)	A	2.2	0.5	6	8.0
TAP 335(+016)	A	3.3	0.5	6	6.0
TAP 475(+016)	B	4.7	0.6	6	5.0
TAP 685(+016)	C	6.8	0.8	6	4.0
TAP 106(+016)	D	10	1.2	8	3.2
TAP 156(+016)	E	15	1.9	8	2.5
TAP 226(+016)	F	22	2.8	8	2.0
TAP 336(+016)	F	33	4.2	8	1.6
TAP 476(+016)	J	47	6.0	8	1.3
TAP 686(+016)	L	68	8.7	8	1.0
TAP 107(+016)	N	100	12.8	10	0.8
TAP 157(+016)	N	150	19.2	10	0.6
TAP 227(+016)	R	220	20.0	10	0.5
20 volt @ 85°C (13 volt @ 125°C)					
TAP 105(+020)	A	1.0	0.5	4	10.0
TAP 155(+020)	A	1.5	0.5	4	9.0
TAP 225(+020)	A	2.2	0.5	6	7.0
TAP 335(+020)	B	3.3	0.5	6	5.5
TAP 475(+020)	C	4.7	0.7	6	4.5
TAP 685(+020)	D	6.8	1.0	6	3.6
TAP 106(+020)	E	10	1.6	8	2.9
TAP 156(+020)	F	15	2.4	8	2.3
TAP 226(+020)	H	22	3.5	8	1.8

AVX Part No.	Case Size	Capacitance μF	DCL (μA) Max.	DF % Max.	ESR Max. (Ω) @ 100 kHz
20 volt @ 85°C (13 volt @ 125°C) continued					
TAP 336(+020)	J	33	5.2	8	1.4
TAP 476(+020)	K	47	7.5	8	1.2
TAP 686(+020)	N	68	10.8	8	0.9
TAP 107(+020)	N	100	16.0	10	0.6
25 volt @ 85°C (16 volt @ 125°C)					
TAP 105(+025)	A	1.0	0.5	4	10.0
TAP 155(+025)	A	1.5	0.5	4	8.0
TAP 225(+025)	A	2.2	0.5	6	6.0
TAP 335(+025)	B	3.3	0.6	6	5.0
TAP 475(+025)	C	4.7	0.9	6	4.0
TAP 685(+025)	D	6.8	1.3	6	3.1
TAP 106(+025)	E	10	2.0	8	2.5
TAP 156(+025)	F	15	3.0	8	2.0
TAP 226(+025)	H	22	4.4	8	1.5
TAP 336(+025)	J	33	6.6	8	1.2
TAP 476(+025)	M	47	9.4	8	1.0
TAP 686(+025)	N	68	13.6	8	0.8
35 volt @ 85°C (23 volt @ 125°C)					
TAP 104(+035)	A	0.1	0.5	4	26.0
TAP 154(+035)	A	0.15	0.5	4	21.0
TAP 224(+035)	A	0.22	0.5	4	17.0
TAP 334(+035)	A	0.33	0.5	4	15.0
TAP 474(+035)	A	0.47	0.5	4	13.0
TAP 684(+035)	A	0.68	0.5	4	10.0
TAP 105(+035)	A	1.0	0.5	4	8.0
TAP 155(+035)	A	1.5	0.5	4	6.0
TAP 225(+035)	B	2.2	0.6	6	5.0
TAP 335(+035)	C	3.3	0.9	6	4.0
TAP 475(+035)	E	4.7	1.3	6	3.0
TAP 685(+035)	F	6.8	1.9	6	2.5
TAP 106(+035)	F	10	2.8	8	2.0
TAP 156(+035)	H	15	4.2	8	1.6
TAP 226(+035)	K	22	6.1	8	1.3
TAP 336(+035)	M	33	9.2	8	1.0
TAP 476(+035)	N	47	10.0	8	0.8
50 volt @ 85°C (33 volt @ 125°C)					
TAP 104(+050)	A	0.1	0.5	4	26.0
TAP 154(+050)	A	0.15	0.5	4	21.0
TAP 224(+050)	A	0.22	0.5	4	17.0
TAP 334(+050)	A	0.33	0.5	4	15.0
TAP 474(+050)	A	0.47	0.5	4	13.0
TAP 684(+050)	B	0.68	0.5	4	10.0
TAP 105(+050)	C	1.0	0.5	4	8.0
TAP 155(+050)	D	1.5	0.6	4	6.0
TAP 225(+050)	E	2.2	0.8	6	3.5
TAP 335(+050)	F	3.3	1.3	6	3.0
TAP 475(+050)	G	4.7	1.8	6	2.5
TAP 685(+050)	H	6.8	2.7	6	2.0
TAP 106(+050)	J	10	4.0	8	1.6
TAP 156(+050)	K	15	6.0	8	1.2
TAP 226(+050)	L	22	8.8	8	1.0

(*) Insert capacitance tolerance code; M for $\pm 20\%$, K for $\pm 10\%$ and J for $\pm 5\%$

NOTE: Voltage ratings are minimum values. AVX reserves the right to supply higher voltage ratings in the same case size.

SOLID TANTALUM RESIN DIPPED TAP

TAPE AND REEL PACKAGING FOR AUTOMATIC COMPONENT INSERTION

TAP types are all offered on radial tape, in reel or 'ammo' pack format for use on high speed radial automatic insertion equipment, or preforming machines.

The tape format is compatible with EIA 468A standard for component taping set out by major manufacturers of radial automatic insertion equipment.

TAP – available in three formats. See page 134 for dimensions.

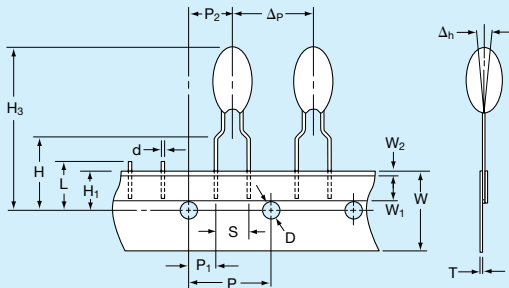

'B' wires for normal automatic insertion on 5mm pitch.

BRW suffix for reel
BRS suffix for 'ammo' pack
Available in case sizes A - J

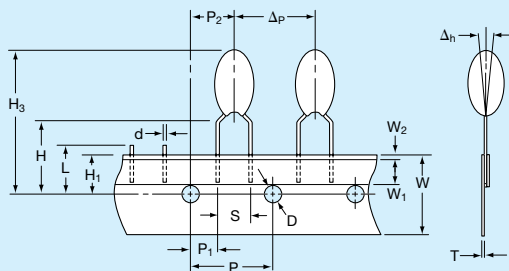

'C' wires for preforming.

CRW suffix for reel
CRS suffix for 'ammo' pack
Available in case sizes A - R

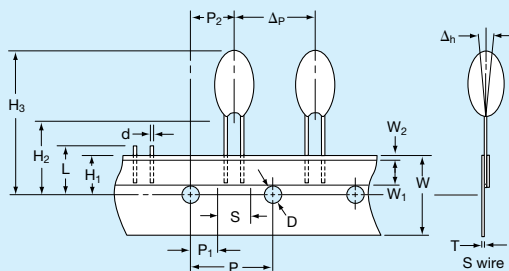

'S' and 'D' wire for special applications, automatic insertion on 2.5mm pitch.

SRW, DTW suffix for reel
SRS, DTS suffix for 'ammo' pack
Available in case sizes A - J

Dipped Radial Capacitors



Tape and Reel Packaging

SOLID TANTALUM RESIN DIPPED TAP

DIMENSIONS:

Description	Code	Dimension millimeters (inches)
Feed hole pitch	P	12.7 ± 0.30 (0.500 ± 0.010)
Hole center to lead	P ₁	3.85 ± 0.70 (0.150 ± 0.030) to be measured at bottom of clench
		5.05 ± 1.00 (0.200 ± 0.040) for S wire
Hole center to component center	P ₂	6.35 ± 0.40 (0.250 ± 0.020)
Change in pitch	Δp	± 1.00 (± 0.040)
Lead diameter	d	0.50 ± 0.05 (0.020 ± 0.003)
Lead spacing	S	See wire form table
Component alignment	Δh	0 ± 2.00 (0 ± 0.080)
Feed hole diameter	D	4.00 ± 0.20 (0.150 ± 0.008)
Tape width	W	18.0 + 1.00 (0.700 + 0.040) - 0.50 - 0.020)
Hold down tape width	W ₁	6.00 (0.240) min.
Hold down tape position	W ₂	1.00 (0.040) max.
Lead wire clench height	H	16.0 ± 0.50 (0.630 ± 0.020)
		19.0 ± 1.00 (0.750 ± 0.040) on request
Hole position	H ₁	9.00 ± 0.50 (0.350 ± 0.020)
Base of component height	H ₂	18.0 (0.700) min. (S wire only)
Component height	H ₃	32.25 (1.300) max.
Length of snipped lead	L	11.0 (0.430) max.
Total tape thickness	T	0.70 ± 0.20 (0.030 ± 0.001)
		Carrying card 0.50 ± 0.10 (0.020 ± 0.005)

REEL CONFIGURATION AND DIMENSIONS:

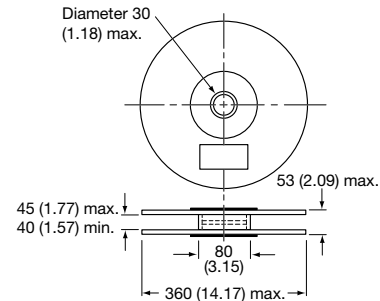

Manufactured from cardboard with plastic hub.

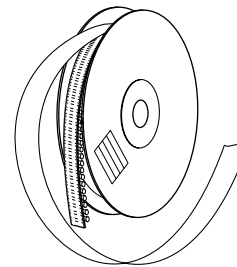

Holding tape outside. Positive terminal leading.

PACKAGING QUANTITIES

For Reels

Style	Case size	No. of pieces
TAP	A	1500
	B, C, D	1250
	E, F	1000
	G, H, J	750
	K, L, M, N, P, R	500

For 'Ammo' pack

Style	Case size	No. of pieces
TAP	A, B, C, D	3000
	E, F, G	2500
	H, J	2000
	K, L, M, N, P, R	1000

For bulk products

Style	Case size	No. of pieces
TAP	A to H	1000
	J to L	500
	M to R	100

AMMO PACK DIMENSIONS

millimeters (inches) max.

Height 360 (14.17), width 360 (14.17), thickness 60 (2.36)

GENERAL NOTES

Resin dipped tantalum capacitors are only available taped in the range of case sizes and in the modular quantities by case size as indicated.

Packaging quantities on tape may vary by ±1%.