

# UMR

## Epoxy-Dipped Radial Lead Inductive Film/Foil Capacitors



- Coupling
- Ceramic Disk Alternative
- Blocking
- Bypass

<b>Operating Temperature Range</b>		<b>-55°C to 85°C</b>	
<b>Capacitance Tolerance</b>		<b>±10% at 1kHz, 25°C</b>	
<b>Voltage Range</b>	<b>WVDC</b>	<b>100</b>	
	<b>VAC</b>	63	
<b>Dissipation Factor</b>		<b>1.0% at 1 kHz, 25°C</b>	
<b>Insulation Resistance</b>		<b>30,000 MΩ</b>	
<b>2,000 hours, +85°C with 125% rated DC voltage</b>			
<b>Load Life</b>	Capacitance Change	≤8% maximum	
	Dissipation Factor Change	<110% maximum specification	
	Insulation Resistance	≥ 4,500 MΩ	
<b>250 hours, 95% RH, 25°C and no applied voltage</b>			
<b>Humidity Test</b>	Capacitance Change	<10% of initial readings @ +25°C, 1kHz	
	Dissipation Factor Change	≤ 10% of initial +25°C 1kHz	
	Insulation Resistance	≥ Minimum 2700MΩ	
<b>Self-inductance</b>		≤1 nH/mm along the capacitor pitch	
<b>Capacitance Drift Factor</b>		(after 2 years) ≤ 3.0% up to 40°C	
<b>Capacitance Temperature Coefficient</b>		+500 ppm/°C, ± 200ppm/°C	
<b>Type</b>		Inductive film/foil	
<b>Dielectric</b>		Polyester film	
<b>Electrodes</b>		Aluminum foil	
<b>Leads</b>		Tinned copper wire	
<b>Coating</b>		Flame retardant epoxy sealed resin (UL 94V-0)	



**ILLINOIS CAPACITOR, INC.** 3757 W. Touhy Ave., Lincolnwood, IL 60712 • (847) 675-1760 • Fax (847) 673-2850 • [www.illcap.com](http://www.illcap.com)

## STANDARD PART LISTING

Capacitance (μF)	WVDC	ic <sup>®</sup> PART NUMBER	dv/dt (v/μs)	L Max.	H Max.	T Max.	S Lead Spacing	d Lead Wire Diameter
.001	100	102UMR100K	10	5.5	10.5	3.0	3.5	0.5
.0015	100	152UMR100K	10	5.5	10.5	3.0	4.0	0.5
.0022	100	222UMR100K	10	5.5	10.5	3.0	4.0	0.5
.0033	100	332UMR100K	10	5.5	10.5	3.0	4.0	0.5
.0039	100	392UMR100K	10	5.5	10.5	3.0	4.0	0.5
.0047	100	472UMR100K	10	5.5	10.5	3.0	4.0	0.5
.0056	100	562UMR100K	10	5.5	10.5	3.0	4.0	0.5
.0068	100	682UMR100K	10	5.5	10.5	3.0	4.0	0.5
.01	100	103UMR100K	10	6.5	10.5	3.0	5.0	0.5
.015	100	153UMR100K	10	6.5	11.5	3.0	5.0	0.5
.022	100	223UMR100K	10	6.5	11.5	3.5	5.0	0.5
.033	100	333UMR100K	10	7.5	11.5	3.5	6.5	0.5
.047	100	473UMR100K	10	7.5	12.5	4.5	6.5	0.5
.056	100	563UMR100K	10	9.0	12.5	4.5	7.0	0.5
.068	100	683UMR100K	10	9.0	12.5	4.5	7.0	0.5
.1	100	104UMR100K	10	10.0	12.5	5.5	7.5	0.5
.15	100	154UMR100K	10	12.5	18.5	6.0	8.5	0.5
.22	100	224UMR100K	10	12.5	18.5	6.0	8.5	0.6
.33	100	334UMR100K	10	15.0	19.5	8.0	9.5	0.6
.47	100	474UMR100K	10	18.5	19.5	11.5	10.0	0.6

Convert to inches, divide by 25.4

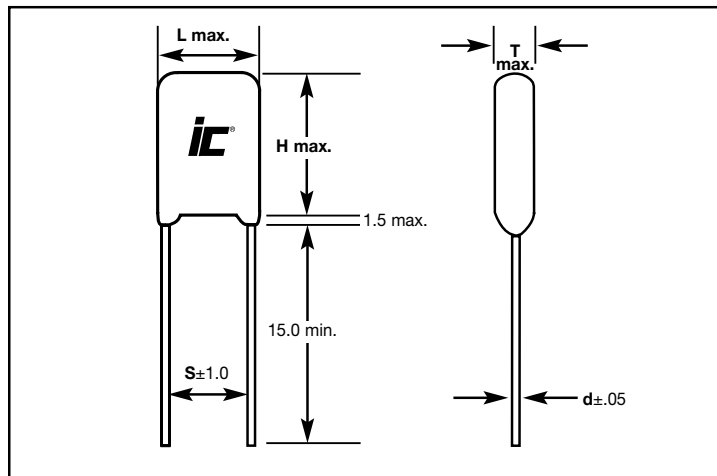

## ENVIRONMENTAL/ENDURANCE DATA

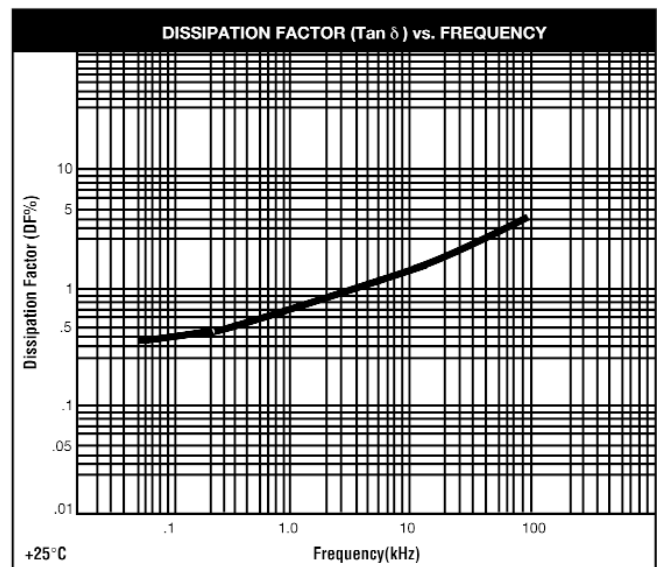
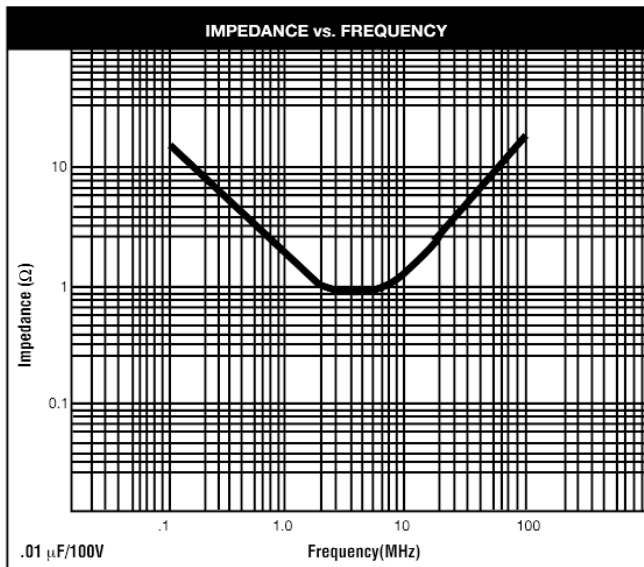
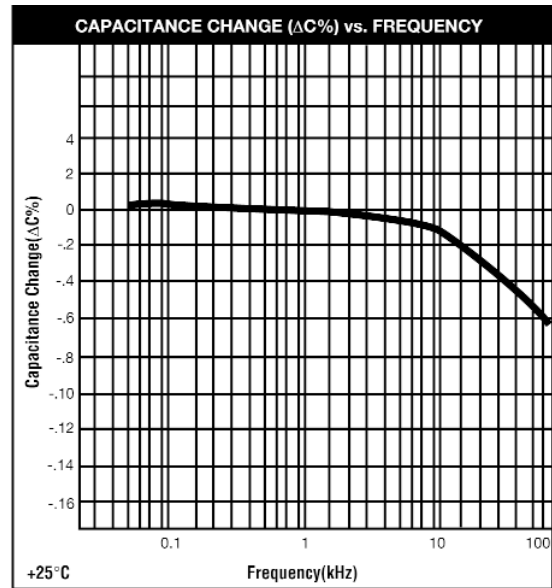
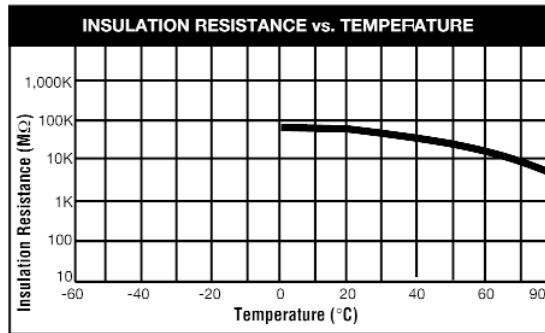
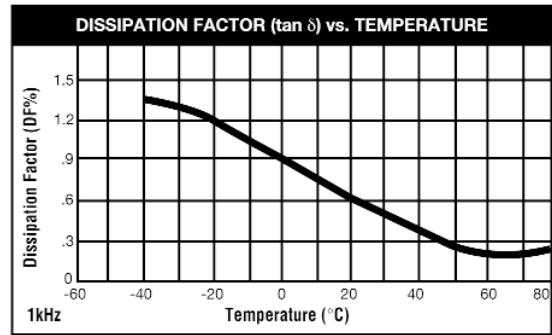
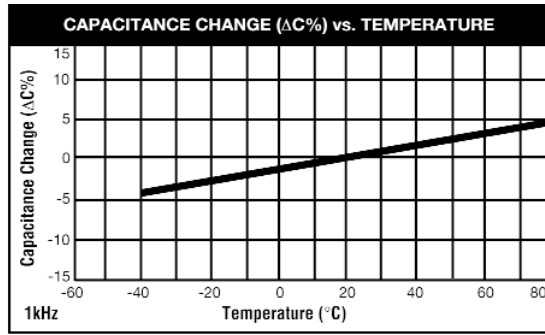

NOTE: These graphs reflect typical measurements.

## RADIAL LEAD TAPING SPECIFICATIONS

### GENERAL SPECIFICATIONS

#### FILM CAPACITORS BODY SIZE:

- Maximum Body Length (L): 10.5 mm
- Minimum Body Height (Hc): 12.5 mm
- Maximum Body Thickness (T): 6.5 mm

**INTERRUPTION OF SEQUENCE:** No consecutive capacitors may be absent. Empty spaces < 0.1% of package quantity.

**SPLICES:** Spliced tape strength is equal to non-spliced tape  
Splice thickness is ≤ 4 single tape layers  
Splice offset ± .3mm

**REFERENCE STANDARD:** EIA RS 468A

TAPE REFERENCE DIMENSIONS		
Carrier Width (W)	18.0	±0.5
Capacitor Bottom to Feed Hole (H)	20.0	±.75
Height of Seating Plane (Formed Lead) H <sub>0</sub>	16.0	±0.5
Lead Spacing: (Formed) (F)	5.0	±0.5
Capacitor Pitch (P)	12.7	±1.00
Sprocket Hole Pitch (P <sub>0</sub> )	12.7	±0.30
Sprocket Hole Dia. (F)	4.0	±0.30
Front Back Alignment (Δ)	0	±1.00
Case Top to Feed Hole (H <sub>1</sub> )	32.0	Max.
Sprocket Hole to First Lead (P <sub>1</sub> )	3.85	±.70
Lead Extension (I)	2.2	Max.
Component Tape Width (C)	43.2	Max.
Cut Out Length (L <sub>1</sub> )	11.0	Max.
Sprocket Hole Position (W <sub>1</sub> )	9.0	±0.5

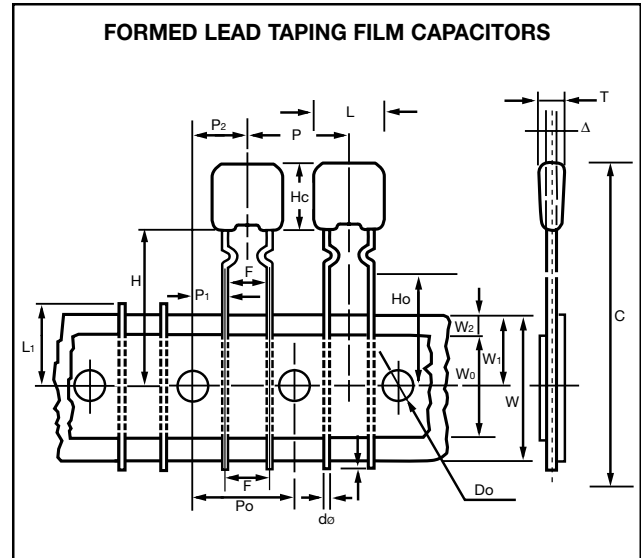

### AMMO PACKAGING

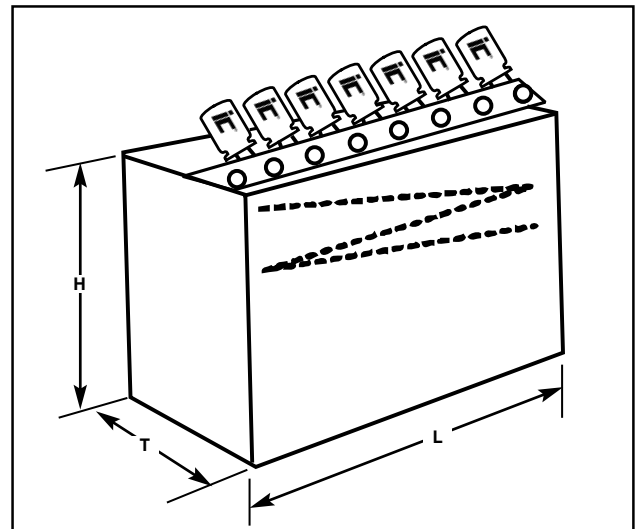

### QUANTITIES PER BOX

Capacitance (μF)	Ammo
.001 - .0082	3,500
.010 - .012	3,000
.015 - .027	3,000
.032 - .047	2,000
.056 - .068	1,500
.082 - .1	1,000

BOX DIMENSIONS			mm
L (max)	H (max)	T (max)	
340	360	65	