

Features

- Award winning kinematic design allows rapid connection/disconnection.
- High retention force with socket (at angles less than 30°) and eight point contact ensures low contact resistance.
- Low detachment force with socket (at angles greater than 30°) reduces risk of inadvertent damage to pcb during test.
- Surface mount, self retaining and straight shank designs available.
- Hand or semi-automatic machine assembly. Details on request.

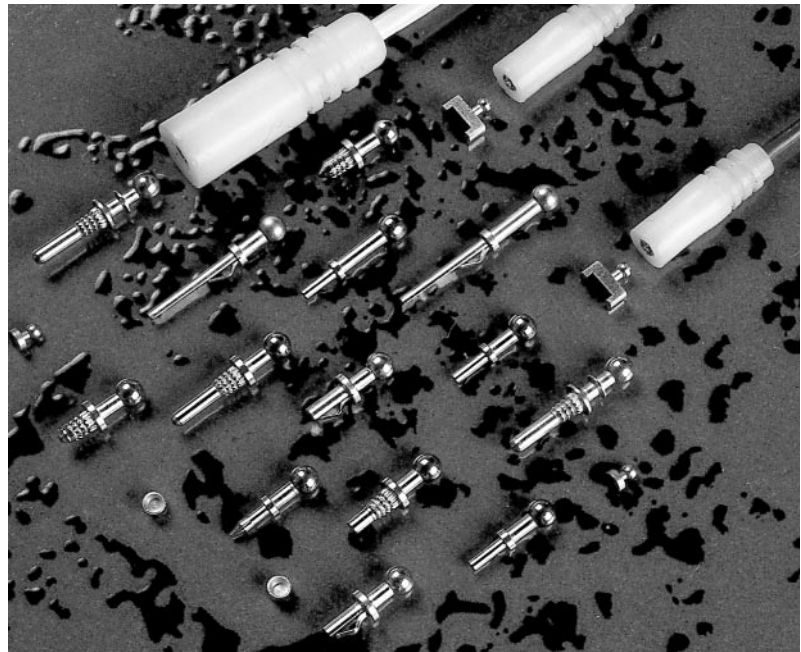

Approvals

- Approved to BS 9000 (BS 9525 F0050)

Application

- Plated through hole, multilayer and ceramic and printed circuits and hybrids.

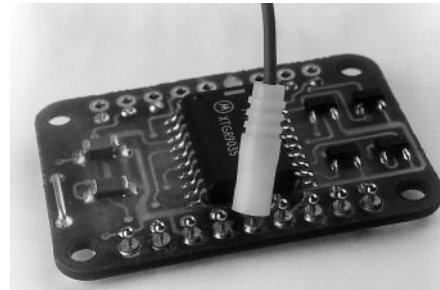

Miscellaneous

- SMOX/060/B1/LP and SMOX/060/B1 available packaged in 8 mm wide, 4 mm pitch clear tape on 7 inch (3,000 components) and 1 3/4 inch (10,000 components) reels.

Snaplox®

The Snaplox® name has firmly established itself in the world electronics market. The award winning design has yielded use in a vast range of applications in the commercial and military electronics world. Applications which use them include towed sonar arrays and rolling stock electronics equipment.

The Snaplox® concept enables highly accurate testing to be done whilst reducing the risk of board damage. This is due to the unique ball and socket arrangement which provides 8 points of low resistance contact through a 60° connection angle. Beyond this 60° the socket disconnects with ease preventing stress to the pin and board.

The standard finishes are palladium or Gold plated pin and PTFE insulated Silver plated socket to give a robust, long life, low contact resistance test point system. Other finishes are available on request.

They are available with a range of PCB (surface mount, Kinky Pin and Snale) and chassis mounting (Barb Cone-Lock) retention mechanisms to suit most applications and bespoke styles can be manufactured as needed due to our in-house, high precision machining capabilities.

Prefix: 060/-
 Mounting Hole Diameter:
 1.52 mm (0.060") - 1.62 mm (0.064")
PCB Thickness:
 1.4 mm (0.055") min.
Shoulder Diameter A:
 2.4 mm (0.094")
Assembly Tool:
 Snaplox Kinky-Pins - AT 1/KP2

Snaplox (Surface Mount)

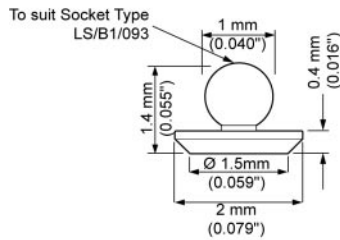

SMOX/060/B1/LP
 (To suit socket type LS/B1/093)

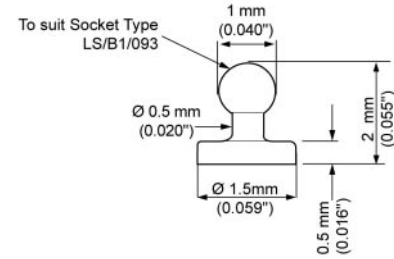

SMOX/060/B1

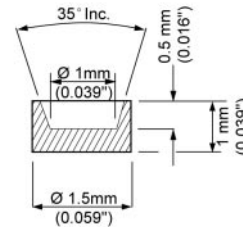

SMOX/060/TP
 Contact Test Point

LS/B1/093
 To mate with:
 AT 2/15 & ATS 3/08

1 mm Miniature Snaplox Socket

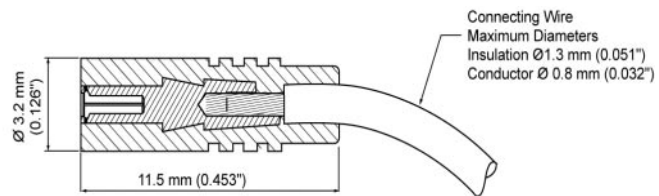

LS/B1/093
 (All 1 mm (0.040") Snaplox)

Part Number: 030/B1/KP2

Mounting Hole Diameter:
0.81 mm (0.032") - 0.96 mm (0.038")

PCB Thickness:
1.4 mm (0.055") min.

Shoulder Diameter A:
1.6 mm (0.063")

Assembly Tool:
Snaplox Kinky-Pins - AT 1/KP2

Part Number: 040/B1/KP2

Mounting Hole Diameter:
0.96 mm (0.038") - 1.12 mm (0.044")

PCB Thickness:
1.4 mm (0.055") min.

Shoulder Diameter A:
1.6 mm (0.063")

Assembly Tool:
Snaplox Kinky-Pins - AT 1/KP2

Part Number: 050/B1/KP2

Mounting Hole Diameter:
1.21 mm (0.048") - 1.37 mm (0.054")

PCB Thickness:
1.4 mm (0.055") min.

Shoulder Diameter A:
2.4 mm (0.094")

Assembly Tool:
Snaplox Kinky-Pins - AT 1/KP2

Part Number: SN/040/-/B1

Mounting Hole Diameter:
0.81 mm (0.032") - 0.96 mm (0.038")

PCB Thickness:
1.4 mm (0.055") min.

Shoulder Diameter A:
1.6 mm (0.063")

Assembly Tool:
Snaplox Kinky-Pins - AT 1/09

Part Number: 062/B1

Mounting Hole Diameter:
1.57 mm (0.062")

PCB Thickness:
0.56 mm (0.022") - 0.71 (0.028")

Shoulder Diameter A:
N/A

Assembly Tool:
AT 1/01

1 mm Miniature Snaplox (Kinky Pin)

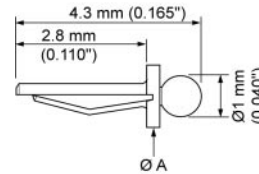

030/B1/KP2
040/B1/KP2
050/B1/KP2

1 mm Miniature Snaplox (Snale)

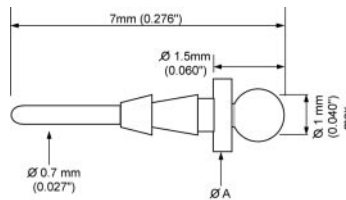

SN/040/LT/B1

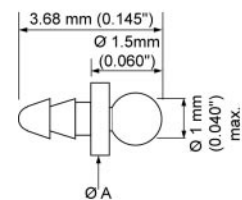

SN/040/SO/B1

1 mm Miniature Snaplox (Barb Cone Lock)

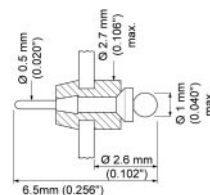

062/B1

Prefix: 028/-

Mounting Hole Diameter:
0.68 mm (0.027") - 0.84 mm (0.033")

PCB Thickness:
1.4 mm (0.055") min.

Shoulder Diameter A:
1.6 mm (0.063")

Assembly Tool:
AT 1/KP2

Prefix: 030/-

Mounting Hole Diameter:
0.81 mm (0.032") - 0.96 mm (0.038")

PCB Thickness:
1.4 mm (0.055") min.

Shoulder Diameter A:
1.6 mm (0.063")

Assembly Tool:
AT 1/KP2

Prefix: 040/-

Mounting Hole Diameter:
0.96 mm (0.038") - 1.12 mm (0.044")

PCB Thickness:
1.4 mm (0.055") min.

Shoulder Diameter A:
1.6 mm (0.063")

Assembly Tool:
AT 1/KP2

Prefix: 050/-

Mounting Hole Diameter:
1.21 mm (0.048") - 1.37 mm (0.054")

PCB Thickness:
1.4 mm (0.055") min.

Shoulder Diameter A:
2.4 mm (0.094")

Assembly Tool:
AT 1/KP2

Prefix: 060/-

Mounting Hole Diameter:
1.52 mm (0.060") - 1.62 mm (0.064")

PCB Thickness:
1.4 mm (0.055") min.

Shoulder Diameter A:
2.4 mm (0.094")

Assembly Tool:
AT 1/KP2

Kinky Pin Snaplox
(self retaining compliant fit for plated through hole multilayer pcbs)

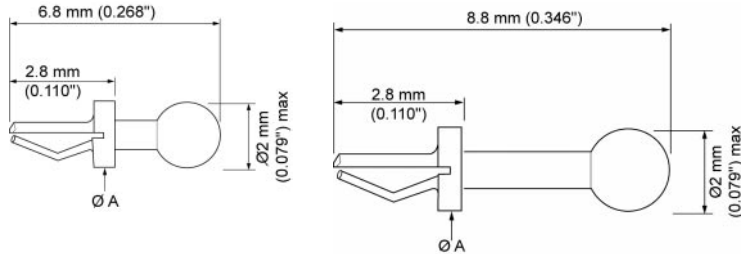

028/SO/BK2P
030/SO/BK2P
040/SO/BK2P
050/SO/BK2P
060/SO/BK2P

028/SO/BK2F
030/SO/BK2F
040/SO/BK2F
050/SO/BK2F
060/SO/BK2F

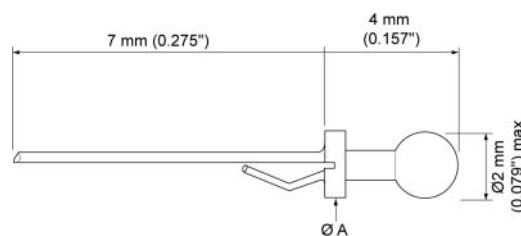

040/LT/BK2P
050/LT/BK2P
060/LT/BK2P

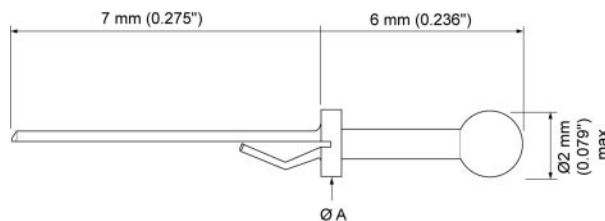

040/LT/BK2F
050/LT/BK2F
060/LT/BK2F

Prefix: B2/PCA/-
Mounting Hole Diameter:
 0.9 mm (0.035") - 1.1 mm (0.043")
PCB Thickness:
 1.4 mm (0.055") min.
Shoulder Diameter A:
 N/A
Assembly Tool:
 AT 1/01

PCB Edge Mounted Snaplox

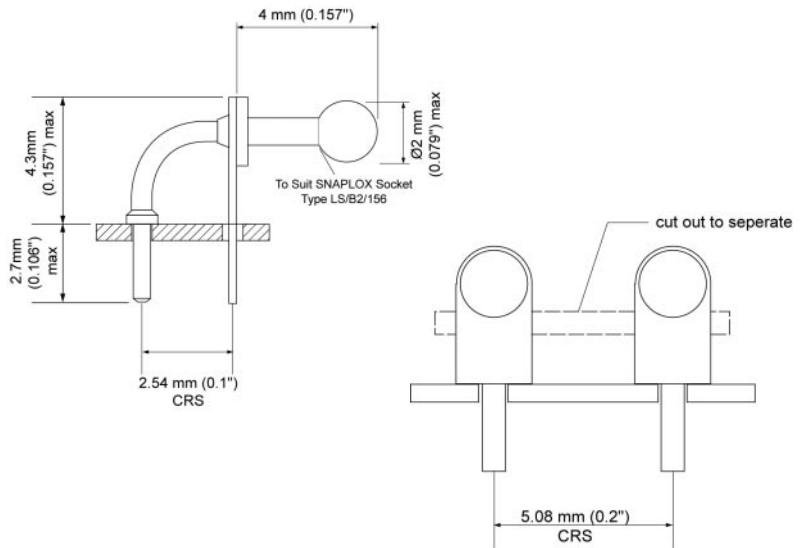

B2/PCA/-
 (Available linked up to 10 ways for ease of assembly)

Prefix: 050/- (Snales)
Mounting Hole Diameter:
 1.25 mm (0.049") - 1.40 mm (0.055")
PCB Thickness:
 1.4 mm (0.055") min.
Shoulder Diameter A:
 2.4 mm (0.094")
Assembly Tool:
 AT 1/09

Snales Snaplox
 (Self Retaining Fit for Single and Double sided pcbs)

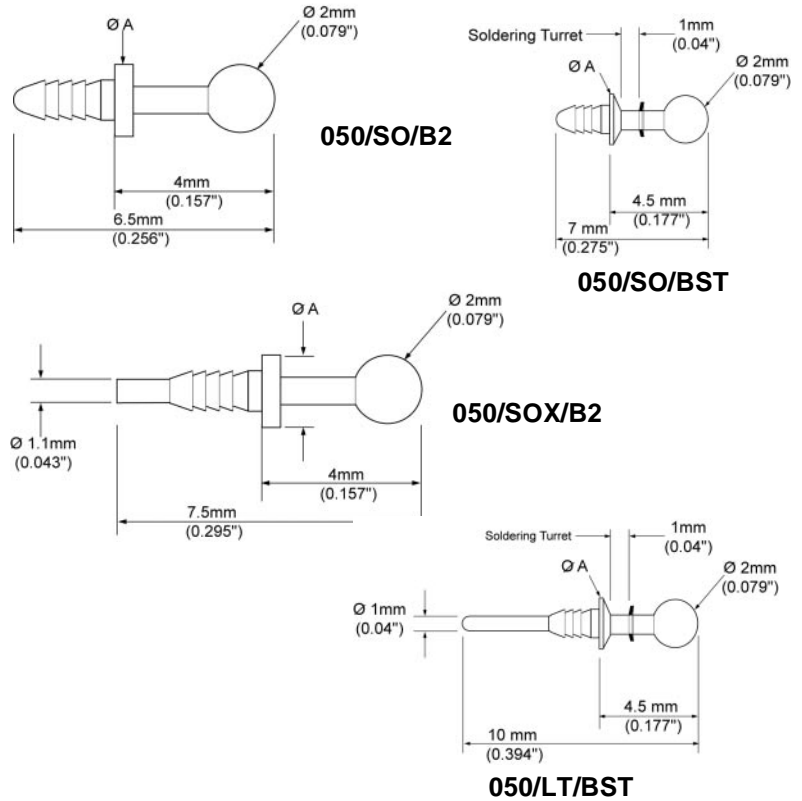

Prefix: 050/-(Snales)

Mounting Hole Diameter:
1.25 mm (0.049") - 1.40 mm (0.055")
PCB Thickness:
1.4 mm (0.055") min.
Shoulder Diameter A:
2.4 mm (0.094")
Assembly Tool:
AT 1/09

Part Number: 030/SO/B2

Mounting Hole Diameter:
0.81 mm (0.032") - 0.92 mm (0.036")
PCB Thickness:
1.65 MM (0.065") - 1.85 MM (0.073")
Shoulder Diameter A:
1.6 mm (0.063")
Assembly Tool:
AT 1/09

Part Number: 030/SO/BF

Mounting Hole Diameter:
0.81 mm (0.032") - 0.92 mm (0.036")
PCB Thickness:
1.65 MM (0.065") - 1.85 MM (0.073")
Shoulder Diameter A:
1.6 mm (0.063")
Assembly Tool:
AT 1/09

Part Number: 030/SO/BCS/-

Mounting Hole Diameter:
0.81 mm (0.032") - 0.92 mm (0.036")
PCB Thickness:
1.65 MM (0.065") - 1.85 MM (0.073")
Shoulder Diameter A:
1.6 mm (0.063")
Assembly Tool:
AT 1/09 or AT 1/KP2

Part Number: 050/B2/RS

Mounting Hole Diameter:
1.25 mm (0.049") - 1.37 mm (0.054")
PCB Thickness:
N/A
Shoulder Diameter A:
2.4 mm (0.094")
Assembly Tool:
AT 1/09

Snale Snaplox Continued

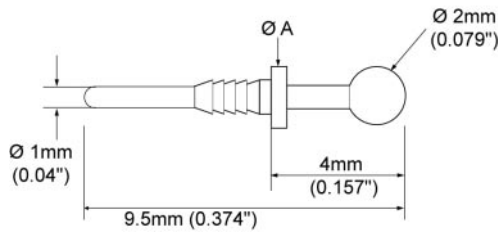

050/LT/B2

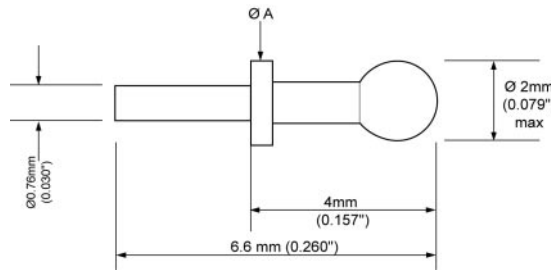

030/SO/B2

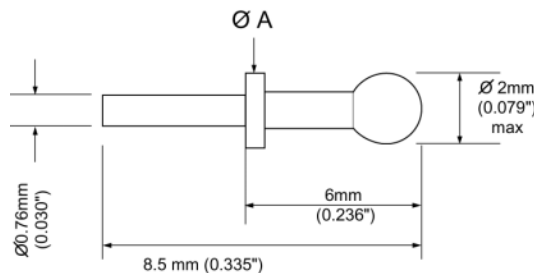

030/SO/BF

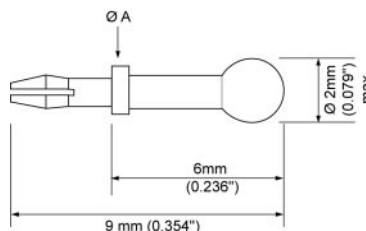

030/SO/BCS/F

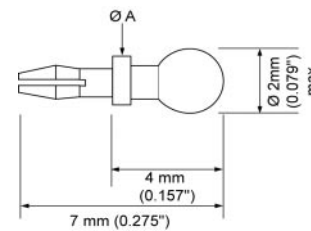

030/SO/BCS/P

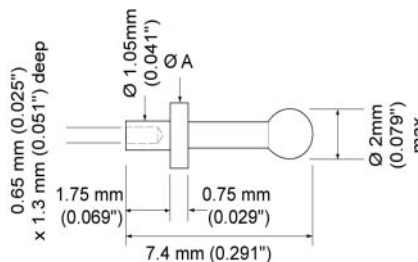

050/B2/RS

Part Number: 156/LP/B2

Mounting Hole Diameter:
3.95 mm (0.155") - 4.05 mm (0.159")

Chassis Thickness:
1.2mm (0.047") - 1.6 mm (0.063")

Assembly Tool:
AT 1/09

Insulated Terminals Snaplox

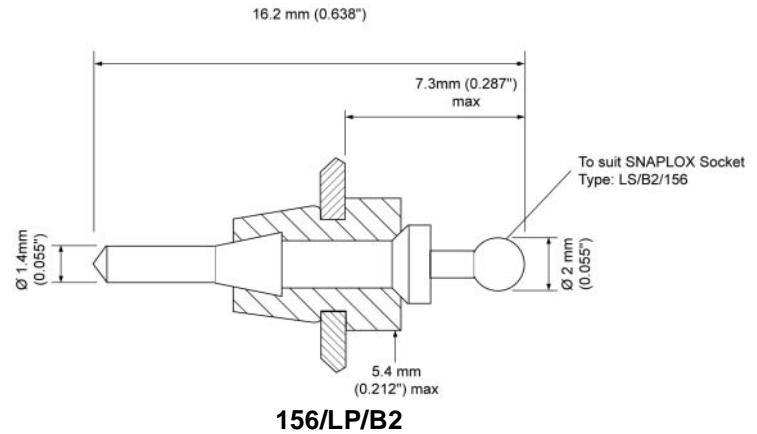

Part Number: LS/B2/156

Assembly Tool:
AT 2/01 & ATS 3/05

Socket (Connects with all 2 mm Snaplox)

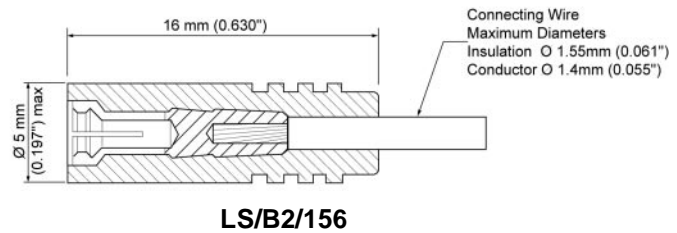

Part Number: LP/B2/156

Assembly Tool:
AT 1/09

Line Plug (Connects with LS/B2/156)

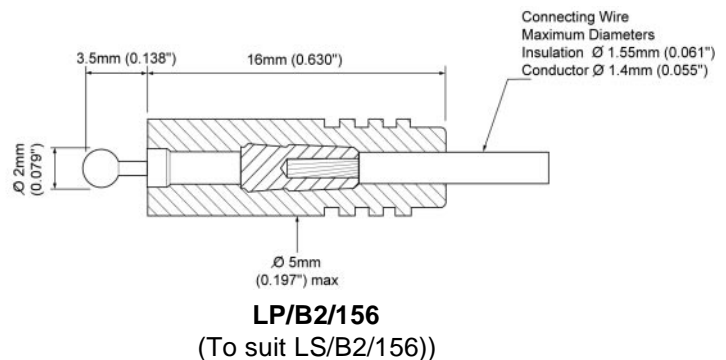

Materials

Pin	Brass
Exceptions Kinky Pin Snaplox SMOX Test Points	Copper alloy Copper alloy
Socket	Copper Alloy
Insulation	High dispersion grade PTFE standard colours - white, black and red. Other colours available on request.
Finishes	
Pin	Palladium
Exceptions Kinky Pin Snaplox B2/PCA/- stirrup	Gold Tin Lead
Socket	Silver

Characteristics

Maximum Contact Resistance (with socket)	2 milliOhms
Maximum Angular Movement before Disconnection	±30°
Socket Insulation Resistance	10,000 MOhms minimum
Typical Retention Force (angles less than 30°)	2 kg (0.2kgs for SMOX/-)
Typical Retention Torque (angles greater than 30°)	200 gcm
Current for 10°C Rise Above Ambient	7 A (3 A for SMOX/-)
Climatic Category	-55 to +125 °C, 56 days damp heat (IEC 68:55/125/56)
Solderability	Exceeds Requirements of BS 2011 (IEC 68) Test T

**Mounting Details and Shoulder
Diameter**

Pin Type No	Mounting Hole Details	PCB Thickness	ØA
028/-	0.68 mm (0.027") - 0.84 mm (0.033")	1.4 mm (0.055") min.	1.6 mm (0.063")
030/-	0.81 mm (0.032") - 0.96 mm (0.038")	1.4 mm (0.055") min.	1.6 mm (0.063")
030/SO/B2	0.81 mm (0.032") - 0.92 mm (0.036")	1.65 mm (0.065") - 1.85 mm (0.073")	1.6 mm (0.063")
030/SO/BF	0.81 mm (0.032") - 0.92 mm (0.036")	1.65 mm (0.065") - 1.85 mm (0.073")	1.6 mm (0.063")
030/SO/BCS/	0.81 mm (0.032") - 0.92 mm (0.036")	1.65 mm (0.065") - 1.85 mm (0.073")	1.6 mm (0.063")
040/-	0.96 mm (0.038") - 1.12 mm (0.044")	1.4 mm (0.055") min.	1.6 mm (0.063")
050/-	1.21 mm (0.048") - 1.37 mm (0.054")	1.4 mm (0.055") min.	2.4 mm (0.094")
050/- (Snales)	1.25 mm (0.049") - 1.40 mm (0.055")	1.4 mm (0.055") min.	2.4 mm (0.094")
050/B2/RS	1.25 mm (0.049") - 1.37 mm (0.054")	N/A	2.4 mm (0.094")
060/-	1.52 mm (0.060") - 1.62 mm (0.064")	1.4 mm (0.055") min.	2.4 mm (0.094")
B2/PCA/-	0.9 mm (0.035") - 1.1 mm (0.043")	1.4 mm (0.055") min.	N/A
156/LP/B2	3.95 mm (0.155") - 4.05 mm (0.159")	1.2 mm (0.047") - 1.6 mm (0.063")	N/A
SMOX/-	2.0 mm min. pad	N/A	N/A
062/B1	1.57 mm (0.062")	0.56 mm (0.022") - 0.71 (0.028")	N/A

Assembly Tools

Component Type Number	Tool Number
Snaplox Kinky Pins	AT 1/KP2
Snaplox Snale Pins	At 1/09
030/SO/B2	AT 1/09
030/SO/BF	AT 1/09
030/SO/BCS/-	AT 1/09 OR at 1/KP2
050/B2/RS	AT 1/09
LS/B1/093	AT 2/15 & ATS 3/08
LS/B2/156	AT 2/01 & ATS 3/05
LP/B2/156	AT 1/09 & ATS 3/05
156/LP/B2	AT 1/09