

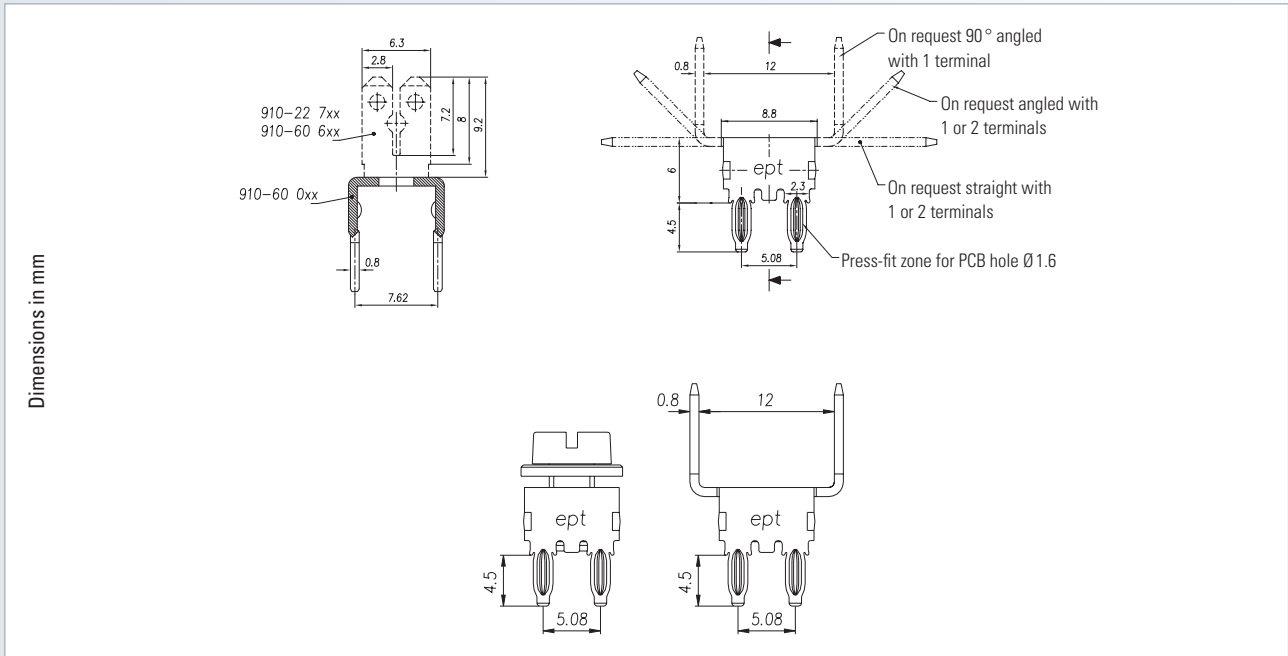

Power terminals
5.08 x 7.62 mm



Pins	Contact arrangement	Press-fit technology – thread M4			
					
		Part number			
4		910-60045	910-22015	910-60645/1	910-22715/1

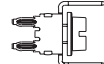
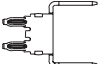
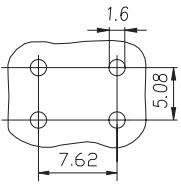

Accessories

- Screws DIN 84 (see page 191)
- Washer (see page 191)
- Lock nut (see page 191)
- Philips screw (see page 191)
- Press-fit tool (see page 216)
- Support tool (see page 217)

On request

- With 1 or 2 terminals angled
- With 1 or 2 terminals straight
- With 1 terminal 90°

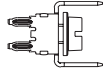
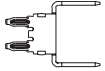
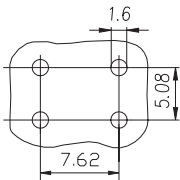

Pins	Contact arrangement	Press-fit technology – thread M5			
					
		Part number			
4		910-60050	910-22020	910-60650/1	910-22720/1

Accessories

- Screws DIN 84 (see page 191)
- Washer (see page 191)
- Lock nut (see page 191)
- Press-fit tool (see page 216)
- Support tool (see page 217)

On request

- Philips screw
- With 1 or 2 terminals angled
- With 1 or 2 terminals straight
- With 1 terminal 90°