

In This Section...

Sta-Kon® Terminal Products and Tools

Overview	F-2-F-3
Ring Terminals	
Nylon-Insulated Ring	F-4-F-6
Vinyl-Insulated Ring	F-7-F-8
Non-Insulated Ring	F-8-F-9
Heavy-Duty Ring	F-10
High-Temperature Non-Insulated Ring	F-11
Tefzel® Insulated Ring	F-11
Nylon-Insulated Rectangular Rings	F-12
Non-Insulated Rectangular Rings	F-12
Non-Insulated Flag Terminals	F-13
Fork and Locking Fork Terminals	
Nylon-Insulated Fork	F-14
Vinyl-Insulated Fork	F-15-F-17
Non-Insulated Fork	F-17-F-18
Pin Terminals	F-18
Splice Connectors	F19-F20
Wire Joints	F-21
Heat-Shrinkable Terminals, Splices and Disconnects	F-22-F-23
Disconnects and Male Tabs	
Female (250 Series)	F-24-F-25
Piggy Back (250 Series)	F-25
Female (187 Series)	F-25
Male Tabs (250 and 187 Series)	F-26
250 Series — Adapters and Coupler	F-27
Male (110 Series Disconnects)	F-27
Wristlock Disconnects	F-27
Plastic Strip Terminals	F-28
Luminaire Disconnects	F-29
Disconnect Installation Tool	F-29
Insulated Ferrules	F-30-F-31
Non-Insulated Ferrules	F-32
Installing Kits	F-33
Application Tools	
Plier Type Tools	F-34
Comfort Crimp® Terminal Tools	F-35
Ratchet Hand Tools	F-36
Flag Terminal Type Hand Tool	F-36
Wire Stripping/Cutting Tools	F-37
Toggle Type Tools	F-37
Shure-Stake® Auto-Feed Tool	F-38
Tooling for Plastic Strip Terminals	F-38
Battery-Powered Crimping Tool	F-39
Bench-Mounted Air Tools	F-40
Portable Air Hydraulic Tool	F-40
Air-Operated Bench-Mounted Tool	F-41
12-Ton Crimping Tools	F-42
Electric Hydraulic Pumps	F-43
Die Selection Charts	F-44-F-46
Wire Guide Tables	F-47-F-49
Military Standard Cross Reference	F-50
Cross Reference for Packaging	F-51-F-52
Catamount® Terminals and Terminal Tools	F-53-F-55
Terminal Info	F-56

Thomas & Betts

United States
Tel: 901.252.8000
800.816.7809
Fax: 901.252.1354

Technical Services
Tel: 888.862.3289

www.tnb.com

Experience the Sta-Kon® advantage!

Thomas & Betts developed the first tool-applied solderless terminals and connectors more than 70 years ago in response to industry awareness of the need for better performance of electrical systems.

Key Features and Benefits

- Metal insulation grip sleeve is included on all nylon terminal for strain relief
- Long barrel selective annealed
- UL® Listed E9808 unless otherwise specified

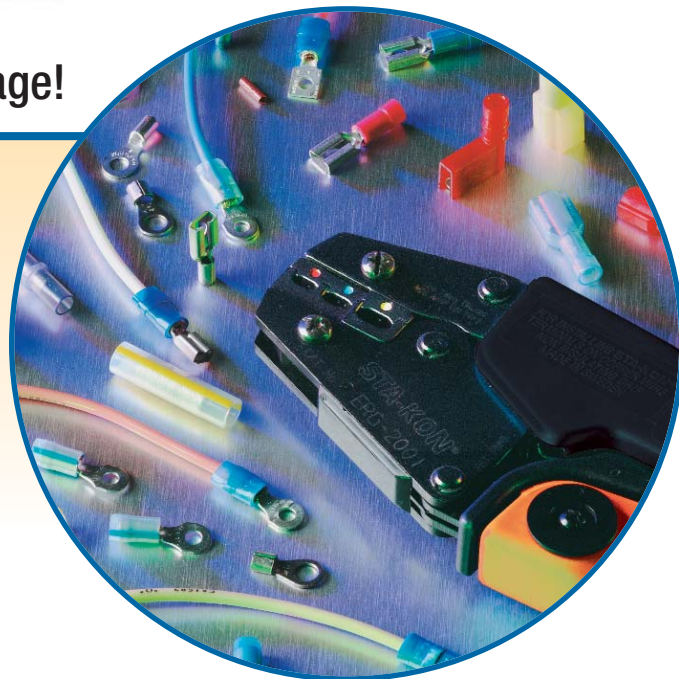

Deep Internal Serrations

After the insertion of a wire into the terminal's barrel, a deep, serrated interior ensures a large area of contact that lowers the resistance of a connection. With the mechanical force of the tool, the wire strands cold flow into the serrated interior. This guarantees electrical resistance lower than the wire to which it is applied. This feature also prevents pullout from vibration and mechanical strain. Deep internal serrations can be compared to the effective holding power of a well-treaded tire on a wet highway.

Funneled Terminal Barrel Entry

This feature makes wire insertion faster and easier. A funneled barrel eliminates wire strand "hang up" upon insertion into the terminal's barrel. The loss of even a couple of wire strands can have negative results on electrical efficiency and resistance to mechanical strain.

Sta-Kon® Long Barrel Design

If lowering electrical resistance, preventing wire pullout, eliminating a "missed" crimp, and an insulator that stays on the barrel during installation are your goals, then you must design a terminal with a long barrel. Most competitive barrel lengths range from 20–50% shorter than Sta-Kon® terminals. The results are usually a stream of electrical failure, rework, and added expense. This also provides the insulator with additional surface area, holding tight to the barrel. Many competitive insulators come off during crimping due to a limited barrel length.

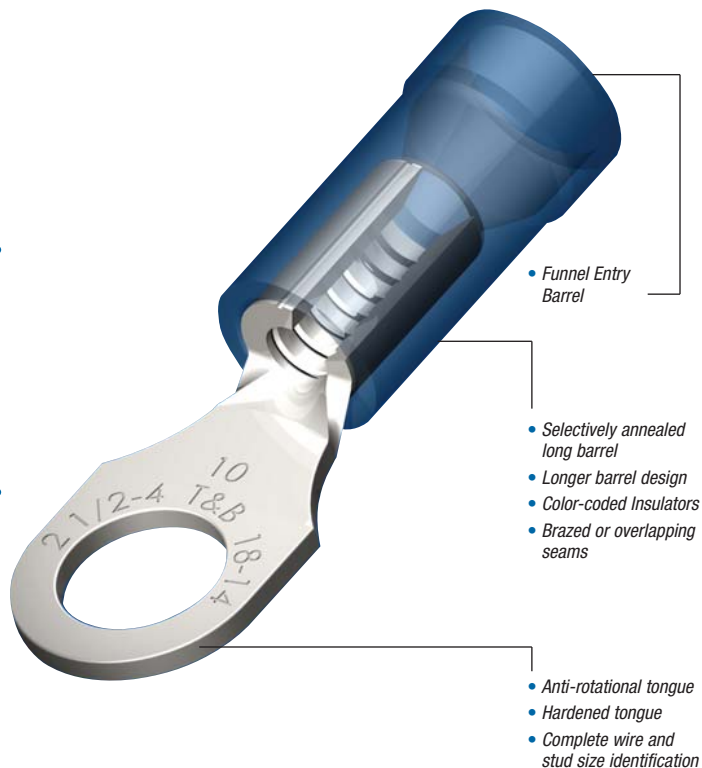

Overview — Why Sta-Kon® Terminals Are Better

Superior terminals for superior connections!

Brazed or Overlapped Seam

A long barrel design is of little value unless it is one solid piece. That is why Thomas & Betts brazes the seam on our vinyl insulated Sta-Kon® terminals and overlaps the seam on nylon insulated terminals. Many competitive terminals have butted seams. This means increased chances for wirestrand loss, poor resistance, wire pullout, and electrical failure. If the installer doesn't position the tool exactly on the correct spot on the barrel, there's likely going to be an improper termination. The butted seam can also fold due to tool-applied pressure piercing the terminal's insulation from the inside out. With a brazed or overlapped seam, the installer can crimp anywhere along the barrel's surface. This provides up to 2.5 times the tensile strength of a butted seam terminal, guaranteeing proper electrical flow, void free.

Selective Annealing

Because of the mechanical strength of copper, an installer can experience fatigue associated with repeated installations. For this reason, Thomas & Betts puts its terminals through one more step called selective annealing. This process leaves the barrel soft enough to crimp and form around the wire. However, we "cold form" the tongue during the manufacturing process so it remains strong. This is done so the tongue can withstand repeated bends and bolt tightening strain common in most electrical installations. Many competitors attempt to accomplish similar goals by removing valuable material or using a softer copper, which has lower conductivity. This increases electrical resistance as well as the odds for shorting and downtime.



Strands enter as a homogeneous group and compact tightly under compression due to fully brazed seam

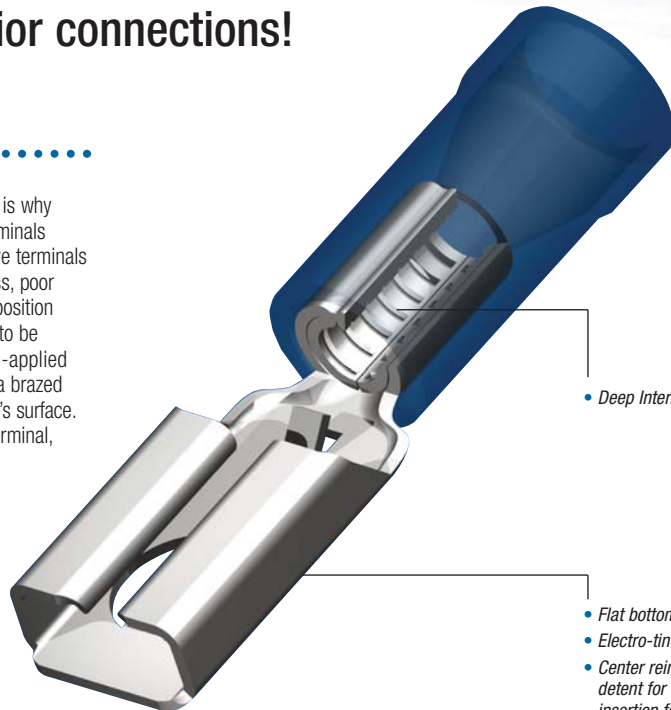

- Deep Internal Serrations
- Flat bottom box
- Electro-tin plating
- Center reinforced spring detent for minimum insertion force
- Compound Spring Rails provide positive contact after repeated insertions

Anti-Rotational Tongues

This is a unique feature to the Thomas & Betts ring tongue terminal. This design prevents terminal shorting by keeping the terminal secure in the terminal block. The installer can place a greater number of terminals closer together without worry.

Proper Identification

We identify all terminals with Thomas & Betts initials, T & B. We also indicate wire and stud sizes. These markings are clearly visible on the surface of the tongue, taking any guesswork out of replacing or reordering additional parts. Our superior bright plating also assists in visibility.

All Sta-Kon® Terminals are Deburred and Degreased

To ensure a Sta-Kon® terminal is properly plated and insulated, all our parts are put through a process that cleans and smooths the terminal of any manufacturing by-products — mainly grease, oils, and sharp edges. Many competitive products do not put their product through such rigorous finishing.

Sta-Kon® Terminal Products and Tools



United States
Tel: 901.252.8000
800.816.7809
Fax: 901.252.1354

Technical Services
Tel: 888.862.3289

Thomas & Betts

www.tnb.com

Sta-Kon®

Nylon-Insulated Ring Terminals

Sta-Kon® Terminal Products and Tools

Sta-Kon® Rings, Forks and Locking Forks

- Complete line of installing tools engineered to match tool with terminal
- First to gain military approval for pressure connections... many styles available for military applications
- Sta-Kon® products exceed test specification requirements of military, UL®, and CSA
- Tefzel® and Nylon Terminals provided with extra metal sleeve to grip insulation
- Vinyl insulated and bare Sta-Kon® terminals feature brazed seam wire barrels that can be crimped at any place on the barrel circumference
- Can be installed with crimping tools having a single indenter or double indenter (recommended for solid wire)
- Serrated barrel increases grip on wire
- Wire range identification on the tongue of each terminal
- Can be installed with crimping tools having a single indenter or double indenter (recommended for solid wire)
- Constructed of electrolytic copper for high conductivity
- Wire range identification on the tongue of each terminal



Listing

Sta-Kon® Rings, Forks and Locking Forks are tested and listed to UL® 486A/B, two-way splices to UL 486C, disconnects to UL 310, and all applicable products to CSA 22.2.



Nylon-Insulated Ring Terminals

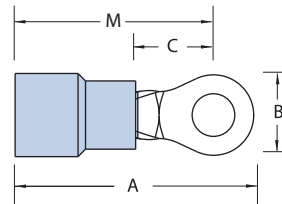

CAT. NO.	PKG. QTY.	WIRE RANGE	MAX. INS.	BOLT HOLE	REC. TOOL	DIMENSIONS				STOCK THICK.
						A	B	C	M	
RZ22-2**	100	26-22	.083	#2	ERG2006	.57	.14	.13	.49	.02
RZ22-4**	100	26-22	.083	#4		.65	.21	.20	.54	
RZ22-6**	100	26-22	.083	#6		.65	.21	.20	.54	
RZ22-8**	100	26-22	.083	#8		.75	.25	.23	.62	
RZ22-10**	100	26-22	.083	#10		.75	.25	.23	.62	
RAX23*	1,000	26-24	.125	#2	WT145A	.66	.14	.14	.59	
RAX43*	1,000	26-24	.125	#4		.74	.20	.19	.64	
RAX63*	1,000	26-24	.125	#6		.84	.25	.22	.72	
RAX83*	1,000	26-24	.125	#8		.84	.25	.22	.72	
RAX103*	1,000	26-24	.125	#10		.84	.25	.24	.72	
RA18-4	100	22-16	.136	#4		ERG2001	.72	.23	.14	.59
RA323	1,000	22-16	.136	#4	.72		.23	.14	.59	
RA333	1,000	22-16	.136	#6	.72		.23	.14	.59	
RA18-6	100	22-16	.136	#6	.86		.26	.25	.71	

* Not listed by UL or CSA

** CSA Listed only

CAT. NO.	PKG. QTY.	WIRE RANGE	MAX. INS.	BOLT HOLE	REC. TOOL	DIMENSIONS				STOCK THICK.
						A	B	C	M	
RA853	1,000	22-16	.136	#6	WT145A	.86	.26	.25	.71	.02
RA18-8	100	22-16	.136	#8		.89	.26	.25	.71	
RA833	1,000	22-16	.136	#8		.86	.26	.25	.71	
RA863	1,000	22-16	.136	#8		.89	.26	.25	.71	
RA18-10	100	22-16	.136	#10		.89	.31	.25	.71	
RA873	1,000	22-16	.136	#10		.89	.31	.25	.71	
RA18-14	100	22-16	.136	1/4"		1.10	.46	.31	.84	
RA713	1,000	22-16	.136	1/4"		1.10	.46	.31	.84	
RA18-516	100	22-16	.136	5/8"		1.10	.46	.31	.84	
RA723	1,000	22-16	.136	5/8"		1.10	.46	.31	.84	
RA18-38	100	22-16	.136	3/8"	ERG2001	1.20	.53	.35	.87	.03
RA733	1,000	22-16	.136	3/8"		1.20	.53	.35	.87	
RA18-12	100	22-16	.136	1/2"		1.30	.72	.50	.92	
RA753	1,000	22-16	.136	1/2"		1.30	.72	.50	.92	

Tefzel® is a trademark of DuPont.

Thomas & Betts

www.tnb.com

United States
Tel: 901.252.8000
800.816.7809
Fax: 901.252.1354

Technical Services
Tel: 888.862.3289

Nylon-Insulated Ring Terminals

Nylon-Insulated Ring Terminals (continued)

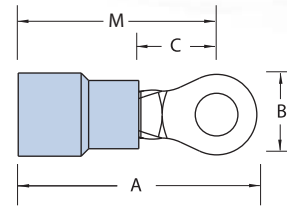

CAT. NO.	PKG. QTY.	WIRE RANGE	MAX. INS.	BOLT HOLE	REC. TOOL	DIMENSIONS				STOCK THICK.
						A	B	C	M	
RB14-4	100	18-14	.162	#4		.72	.26	.14	.59	
RB1323	1,000	18-14	.162	#4		.72	.26	.14	.59	
RB14-6	100	18-14	.162	#6		.89	.31	.25	.71	
RB853	1,000	18-14	.162	#6		.89	.31	.25	.71	
RB1333	1,000	18-14	.162	#6		.74	.26	.14	.59	
RB14-8	100	18-14	.162	#8		.89	.31	.25	.71	
RB863	1,000	18-14	.162	#8		.89	.31	.25	.71	
RB14-10	100	18-14	.162	#10		.89	.31	.25	.71	
RB873	1,000	18-14	.162	#10	ERG2001	.89	.31	.25	.71	.03
RB14-14	100	18-14	.162	1/4"		1.08	.47	.31	.81	
RB713	1,000	18-14	.162	1/4"		1.08	.47	.31	.81	
RB14-516	100	18-14	.162	5/16"		1.08	.47	.31	.84	
RB723	1,000	18-14	.162	5/16"		1.08	.47	.31	.84	
RB14-38	100	18-14	.162	3/8"		1.17	.53	.35	.87	
RB733	1,000	18-14	.162	3/8"		1.17	.53	.35	.87	
RB14-12	100	18-14	.162	1/2"		1.25	.72	.50	.90	
RB753	1,000	18-14	.162	1/2"		1.25	.72	.50	.90	

CAT. NO.	PKG. QTY.	WIRE RANGE	MAX. INS.	BOLT HOLE	REC. TOOL	DIMENSIONS				STOCK THICK.
						A	B	C	M	
RC10-6	50	12-10	.210	#6		1.00	.37	.27	.81	
RC333	500	12-10	.210	#6		1.00	.37	.27	.81	
RC10-8	50	12-10	.210	#8		1.00	.37	.27	.81	
RC863	500	12-10	.210	#8		1.00	.37	.27	.81	
RC10-10	50	12-10	.210	#10		1.00	.37	.27	.81	
RC363	500	12-10	.210	#10		1.00	.37	.27	.81	
RC10-14	50	12-10	.210	1/4"	ERG2001	1.12	.53	.32	.86	.04
RC713	500	12-10	.210	1/4"		1.12	.53	.32	.86	
RC10-516	50	12-10	.210	5/16"		1.21	.53	.31	.94	
RC703	500	12-10	.210	5/16"		1.21	.53	.31	.94	
RC10-38	50	12-10	.210	3/8"		1.27	.59	.35	.98	
RC733	500	12-10	.210	3/8"		1.27	.59	.35	.98	
RC10-12	50	12-10	.210	1/2"		1.37	.72	.52	1.02	
RC753	500	12-10	.210	1/2"		1.37	.72	.52	1.02	

Nylon-Insulated Ring Terminals — Expanded Entry

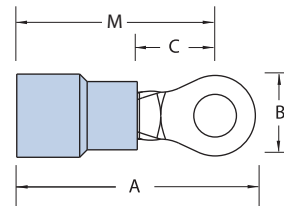

CAT. NO.	PKG. QTY.	WIRE RANGE	MAX. INS.	BOLT HOLE	REC. TOOL	DIMENSIONS				STOCK THICK.
						A	B	C	M	
RB14-4X	100	18-14	.190	#4		.80	.26	.14	.67	
RB1324	1,000	18-14	.190	#4		.80	.26	.14	.67	
RB14-6X	100	18-14	.190	#6		.95	.31	.25	.79	
RB854	1,000	18-14	.190	#6		.95	.31	.25	.79	
RB14-8X	100	18-14	.190	#8		.95	.31	.25	.79	
RB864	1,000	18-14	.190	#8		.95	.31	.25	.79	
RB14-10X	100	18-14	.190	#10		.95	.31	.25	.79	
RB874	1,000	18-14	.190	#10	ERG2001	.95	.31	.25	.79	.03
RB14-14X	100	18-14	.190	1/4"		1.16	.47	.31	.92	
RB714	1,000	18-14	.190	1/4"		1.16	.47	.31	.92	
RB14-516X	100	18-14	.190	5/16"		1.16	.47	.31	.92	
RB724	1,000	18-14	.190	5/16"		1.16	.47	.31	.92	
RB14-38X	100	18-14	.190	3/8"		1.25	.53	.42	.95	
RB734	1,000	18-14	.190	3/8"		1.25	.53	.42	.95	

CAT. NO.	PKG. QTY.	WIRE RANGE	MAX. INS.	BOLT HOLE	REC. TOOL	DIMENSIONS				STOCK THICK.
						A	B	C	M	
RC10-6X	50	12-10	.250	#6		1.10	.37	.27	.91	
RC334	500	12-10	.250	#6		1.10	.37	.27	.91	
RC10-8X	50	12-10	.250	#8		1.10	.37	.27	.91	
RC864	500	12-10	.250	#8		1.10	.37	.27	.91	
RC10-10X	50	12-10	.250	#10		1.10	.37	.27	.91	
RC364	500	12-10	.250	#10		1.10	.37	.27	.91	
RC10-14X	50	12-10	.250	1/4"	ERG2001	1.22	.53	.32	.96	.03
RC714	500	12-10	.250	1/4"		1.22	.53	.32	.96	
RC10-516X	50	12-10	.250	5/16"		1.32	.53	.31	1.05	
RC704	500	12-10	.250	5/16"		1.32	.53	.31	1.05	
RC10-38X	50	12-10	.250	3/8"		1.38	.59	.48	1.09	
RC734	500	12-10	.250	3/8"		1.38	.59	.48	1.09	
RC10-12X	50	12-10	.250	1/2"		1.48	.72	.52	1.13	

UL Listed E9809

United States
Tel: 901.252.8000
800.816.7809
Fax: 901.252.1354

Technical Services
Tel: 888.862.3289

Thomas & Betts

www.tnb.com

Sta-Kon®

Nylon-Insulated Ring Terminals

Nylon-Insulated Large Ring Terminals

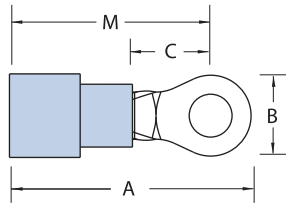

Sta-Kon® Terminal Products and Tools

CAT. NO.	PKG. QTY.	WIRE RANGE	MAX. INS.	BOLT HOLE	REC. TOOL	DIMENSIONS (IN.)				STOCK THICK.	
						A	B	C	M		
RD167	200	8	.340	#8	ERG2007	1.48	.42	.28	1.29		
RD8-10	25	8	.340	#10		1.48	.42	.28	1.29		
RD367	200	8	.340	#10		1.48	.42	.28	1.29		
RD8-14	25	8	.340	¼"		1.54	.46	.36	1.32		
RD717	200	8	.340	¼"		1.54	.46	.36	1.32		
RD8-516	25	8	.340	⅝"		1.63	.57	.36	1.35		
RD727	200	8	.340	⅝"		1.63	.57	.36	1.35		
RD8-38	25	8	.340	⅝"		1.63	.57	.36	1.35		
RD737	200	8	.340	⅝"		1.63	.57	.36	1.35		
RD8-12*	25	8	.310	½"		TBM6S	1.79	.82	.55		1.39
RD757*	200	8	.310	½"	1.79		.82	.55	1.39		
RD10161	200	8AN	.270	#8	ERG2007	1.40	.41	.24	1.20		
RD10361	200	8AN	.270	#10		1.40	.41	.24	1.20		
RD10711	200	8AN	.270	¼"		1.45	.45	.27	1.22		
RD10721	200	8AN	.270	⅝"		1.53	.56	.34	1.25		
RD10731	200	8AN	.270	⅝"		1.53	.56	.34	1.25		
RE6-10	20	6	.420	#10	ERG2007	1.65	.49	.28	1.40		
RE267	200	6	.420	#10		1.65	.49	.28	1.40		
RE6-14	20	6	.420	¼"		1.65	.49	.28	1.40		
RE717	200	6	.420	¼"		1.65	.49	.28	1.40		
RE6-516	20	6	.420	⅝"		1.76	.61	.34	1.47		
RE727	200	6	.420	⅝"		1.76	.61	.34	1.47		
RE6-38	20	6	.420	⅝"		1.76	.61	.34	1.47		
RE737	200	6	.420	⅝"		1.76	.61	.34	1.47		
RE6-12*	20	6	.395	½"		TBM6S	1.83	.82	.55		1.43
RE757*	200	6	.395	½"			1.83	.82	.55		1.43
RE10261	200	6AN	.315	#10	ERG2007	1.55	.49	.24	1.31		
RE10711	200	6AN	.315	¼"		1.55	.49	.27	1.31		
RE10721	200	6AN	.315	⅝"		1.70	.60	.34	1.40		
RE10731	200	6AN	.315	⅝"		1.70	.60	.34	1.40		
RF4-10	15	4	.510	#10	TBM6S	1.76	.56	.36	1.49		
RF267	100	4	.510	#10		1.76	.56	.36	1.49		
RF4-14	15	4	.510	¼"		1.76	.56	.36	1.49		
RF717	100	4	.510	¼"		1.76	.56	.36	1.49		
RF4-516	15	4	.510	⅝"		1.84	.62	.35	1.53		
RF727	100	4	.510	⅝"		1.84	.62	.35	1.53		
RF4-38	15	4	.510	⅝"		1.84	.62	.35	1.53		
RF737	100	4	.510	⅝"		1.84	.62	.35	1.53		
RF757*	100	4	.500	½"		1.90	.82	.55	1.49		
RF10261	100	4AN	.380	#10		1.78	.55	.30	1.51		
RF10711	100	4AN	.380	¼"	1.78	.55	.30	1.51			
RF10721	100	4AN	.380	⅝"	1.80	.62	.34	1.49			
RF10731	100	4AN	.380	⅝"	1.80	.62	.34	1.49			

CAT. NO.	PKG. QTY.	WIRE RANGE	MAX. INS.	BOLT HOLE	REC. TOOL	DIMENSIONS (IN.)				STOCK THICK.	
						A	B	C	M		
RG2-10	10	2	.588	#10		2.15	.69	.40	1.83		
RG267	50	2	.588	#10		2.15	.69	.40	1.83		
RG2-14	10	2	.588	¼"		2.15	.69	.40	1.83		
RG717	50	2	.588	¼"		2.15	.69	.40	1.83		
RG2-516	10	2	.588	⅝"		2.15	.69	.40	1.83		
RG727	50	2	.588	⅝"		2.15	.69	.40	1.83		
RG2-38	10	2	.588	⅝"		2.15	.69	.40	1.83		
RG737	50	2	.588	⅝"		2.15	.69	.40	1.83		
RG2-12	10	2	.588	½"		TBM6S	2.35	.80	.49		1.93
RG757	50	2	.588	½"			2.35	.80	.49		1.93
RG9711	50	2AN	.453	¼"	TBM6S	2.07	.69	.40	1.74	.05	
RG9731	50	2AN	.453	⅝"		2.07	.69	.40	1.74		
RG9751	50	2AN	.453	½"		2.26	.80	.49	1.84		
RH717	50	1/0	.629	¼"	TBM6S	2.14	.77	.43	1.81		
RH727	50	1/0	.629	⅝"		2.14	.77	.43	1.81		
RH737	50	1/0	.629	⅝"		2.14	.77	.43	1.81		
RH757	50	1/0	.629	½"		2.34	.77	.54	1.90		
RH9711	50	1AN	.500	¼"		2.14	.77	.44	1.81		
RH9731	50	1AN	.500	⅝"		2.14	.77	.44	1.81		
RH9751	50	1AN	.500	½"		2.34	.77	.54	1.90		
RJ717	100	2/0	.675	¼"		2.34	.83	.46	1.96		
RJ727	100	2/0	.675	⅝"		2.34	.83	.46	1.96		
RJ737	100	2/0	.675	⅝"		2.34	.83	.46	1.96		
RJ757	100	2/0	.675	½"	2.48	.89	.54	2.03			
RJ9711	50	1/0AN	.550	¼"	TBM6S	2.35	.83	.46	1.97	.06	
RJ9731	50	1/0AN	.550	⅝"		2.35	.83	.46	1.97		
RJ9751	50	1/0AN	.550	½"		2.49	.89	.55	2.04		
RK717	25	3/0	.765	¼"	TBM6S	2.60	.93	.54	2.21		
RK727	25	3/0	.765	⅝"		2.60	.93	.54	2.21		
RK737	25	3/0	.765	⅝"		2.60	.93	.54	2.21		
RK9731	100	2/0AN	.610	⅝"	TBM6S	2.52	.93	.55	2.14		
RK9751	100	2/0AN	.610	½"		2.60	.93	.55	2.15		
RL737	25	4/0	.785	⅝"	TBM6S	2.83	1.04	.57	2.35		
RL757	25	4/0	.785	½"		2.83	1.04	.57	2.35		
RL9731	25	3/0AN	.680	⅝"		2.83	1.04	.57	2.36		
RL9751	25	3/0AN	.680	½"	2.83	1.04	.57	2.36			
RM737	20	250MCM	.868	⅝"	TBM6S	3.00	1.13	.65	2.51	.07	
RM747	20	250MCM	.868	⅝"		3.00	1.13	.65	2.51		
RM757	20	250MCM	.868	½"		3.00	1.13	.65	2.51		
RM9731	20	4/0AN	.750	⅝"		3.00	1.13	.66	2.51		
RM9751	20	4/0AN	.750	½"		3.00	1.13	.66	2.51		

*Braze Seam
AN=Aircraft Wire

Thomas & Betts

www.tnb.com

United States
Tel: 901.252.8000
800.816.7809
Fax: 901.252.1354

Technical Services
Tel: 888.862.3289

Vinyl-Insulated Ring Terminals

Extra-length PVC sleeve offers extra protection.

Vinyl-Insulated Ring Terminals

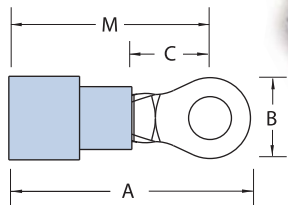

CAT. NO.	PKG. QTY.	WIRE RANGE	MAX. INS.	BOLT HOLE	REC. TOOL	DIMENSIONS (IN.)				STOCK THICK.
						A	B	C	M	
18RA-4	100	22-16	.150	#4		.97	.31	.27	.81	
RA77	1,000	22-16	.150	#4		.97	.31	.27	.81	
18RA-6	100	22-16	.150	#6		.94	.25	.27	.81	
RA857	1,000	22-16	.150	#6		.94	.25	.27	.81	
18RA-8	100	22-16	.150	#8		.97	.31	.27	.81	
RA867	1,000	22-16	.150	#8		.97	.31	.27	.81	
18RA-10	100	22-16	.150	#10		.97	.31	.27	.81	
RA877	1,000	22-16	.150	#10		.97	.31	.27	.81	
18RA-14	100	22-16	.150	1/4"		1.13	.50	.37	.88	
RA717	1,000	22-16	.150	1/4"		1.13	.50	.37	.88	
18RA-516	100	22-16	.150	5/16"		1.13	.50	.37	.88	
RA727	1,000	22-16	.150	5/16"		1.13	.50	.37	.88	
18RA-38	100	22-16	.150	3/8"		1.24	.54	.37	.91	
RA737	1,000	22-16	.150	3/8"		1.24	.54	.37	.91	.03
14RB-4	100	18-14	.170	#4		.94	.25	.27	.81	
RB1327	1,000	18-14	.170	#4		.94	.25	.27	.81	
14RB-6	100	18-14	.170	#6		.97	.31	.27	.81	
RB857	1,000	18-14	.170	#6		.97	.31	.27	.81	
14RB-8	100	18-14	.170	#8		.97	.31	.27	.81	
RB867	1,000	18-14	.170	#8		.97	.31	.27	.81	
14RB-10	100	18-14	.170	#10		.97	.31	.27	.81	
RB877	1,000	18-14	.170	#10		.97	.31	.27	.81	
14RB-14	100	18-14	.170	1/4"		1.14	.50	.38	.89	
RB717	1,000	18-14	.170	1/4"		1.14	.50	.38	.89	
14RB-516	100	18-14	.170	5/16"		1.15	.50	.38	.89	
RB727	1,000	18-14	.170	5/16"		1.15	.50	.38	.89	
14RB-38	100	18-14	.170	3/8"		1.16	.54	.38	.91	
RB737	1,000	18-14	.170	3/8"		1.16	.54	.38	.91	.03
10RC-6	50	12-10	.210	#6		1.06	.31	.27	.90	
RC337	500	12-10	.210	#6		1.06	.31	.27	.90	
10RC-8	50	12-10	.210	#8		1.06	.31	.27	.90	
RC777	500	12-10	.210	#8		1.06	.31	.27	.90	
10RC-10	50	12-10	.210	#10		1.06	.31	.27	.90	
RC367	500	12-10	.210	#10		1.06	.31	.27	.90	
10RC-14	50	12-10	.210	1/4"		1.16	.50	.27	.90	
RC717	500	12-10	.210	1/4"		1.16	.50	.27	.90	
10RC-516	50	12-10	.210	5/16"		1.17	.50	.37	.92	
RC707	500	12-10	.210	5/16"		1.17	.50	.37	.92	
10RC-38	50	12-10	.210	3/8"		1.29	.59	.44	.99	
RC737	500	12-10	.210	3/8"		1.29	.59	.44	.99	.04

A wider wire entry for heavy-wall insulation.

Vinyl-Insulated Ring Terminals — Expanded Insulation

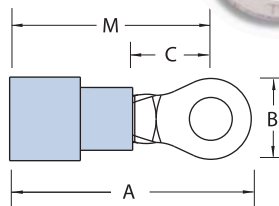

CAT. NO.	PKG. QTY.	WIRE RANGE	MAX. INS.	BOLT HOLE	REC. TOOL	DIMENSIONS (IN.)				STOCK THICK.
						A	B	C	M	
18RA-6X	100	22-16	.170	#6		.97	.31	.27	.81	
18RA-8X	100	22-16	.170	#8		.97	.31	.27	.81	
RA867-170	1,000	22-16	.170	#8		.97	.31	.27	.81	
18RA-10X	100	22-16	.170	#10		.97	.31	.27	.81	
RA877-170	1,000	22-16	.170	#10		.97	.31	.27	.81	
18RA-14X	100	22-16	.170	1/4"		1.13	.50	.37	.88	
RA727-170	1,000	22-16	.170	5/16"		1.13	.50	.37	.88	
14RB-4X	100	18-14	.200	#4		.94	.25	.27	.81	
14RB-6X	100	18-14	.200	#6		.97	.31	.27	.81	.03
RB857-200	1,000	18-14	.200	#6		.97	.31	.27	.81	
14RB-8X	100	18-14	.200	#8		.97	.31	.27	.81	
RB867-200	1,000	18-14	.200	#8		.97	.31	.27	.81	
14RB-10X	100	18-14	.200	#10		.97	.31	.27	.81	
RB877-200	1,000	18-14	.200	#10		.97	.31	.27	.81	
14RB-14X	100	18-14	.200	1/4"	ERG2001	1.14	.50	.38	.89	
RB717-200	1,000	18-14	.200	1/4"		1.14	.50	.38	.89	
14RB-516X	100	18-14	.200	5/16"		1.15	.50	.38	.89	
14RB-38X	100	18-14	.200	3/8"		1.16	.54	.35	.91	
10RC-6X	50	12-10	.250	#6		1.06	.31	.27	.90	
RC337-250	500	12-10	.250	#6		1.06	.31	.27	.90	
10RC-8X	50	12-10	.250	#8		1.06	.31	.27	.90	
RC777-250	500	12-10	.250	#8		1.06	.31	.27	.90	
10RC-10X	50	12-10	.250	#10		1.06	.31	.27	.90	
RC367-250	500	12-10	.250	#10		1.06	.31	.27	.90	.04
10RC-14X	50	12-10	.250	1/4"		1.16	.50	.27	.90	
RC717-250	500	12-10	.250	1/4"		1.16	.50	.27	.90	
10RC-516X	50	12-10	.250	5/16"		1.17	.50	.37	.92	
10RC-38X	50	12-10	.250	3/8"		1.29	.59	.44	.99	
RC737-250	500	12-10	.250	3/8"		1.29	.59	.44	.99	

Sta-Kon Terminal Products and Tools

Sta-Kon®

Insulated and Non-Insulated Ring Terminals

Vinyl-Insulated Large Ring Terminals



Sta-Kon® Terminal Products and Tools

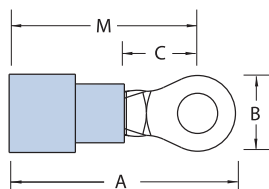

CAT. NO.	WIRE RANGE	MAX. INS.	BOLT HOLE	REC. TOOL	DIMENSIONS				STOCK THICK.
					A	B	C	M	
RDV167	8	.340	#8	ERG2007	1.48	.42	.28	1.17	.04
RDV367	8	.340	#10		1.48	.42	.28	1.17	
RDV717	8	.340	¼"		1.54	.46	.36	1.20	
RDV727	8	.340	⅝"		1.63	.57	.36	1.23	
RDV737	8	.340	⅝"	TBM6S	1.63	.57	.36	1.23	
RDV757*	8	.310	½"		1.79	.82	.55	1.27	
REV267	6	.420	#10	ERG2007	1.65	.45	.28	1.23	
REV717	6	.420	¼"		1.65	.49	.28	1.23	
REV727	6	.420	⅝"		1.76	.61	.34	1.30	
REV737	6	.420	⅝"		1.76	.61	.34	1.30	
REV757*	6	.395	½"	TBM6S	1.83	.82	.55	1.26	

*Brazed Seam

Constructed of electrolytic copper for high conductivity!

Non-Insulated Ring

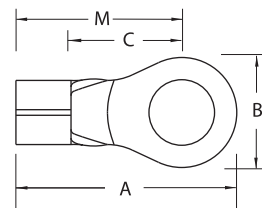

CAT. NO.	PKG. QTY.	WIRE RANGE	BOLT HOLE	REC. TOOL	DIMENSIONS				STOCK THICK.
					A	B	C	M	
A18-4	100	22-16	#4	ERG2002	.75	.31	.27	.59	.03
A18-6	100	22-16	#6		.72	.25	.27	.59	
A85	1,000	22-16	#6		.72	.25	.27	.59	
A18-8	100	22-16	#8		.75	.31	.27	.59	
A86	1,000	22-16	#8		.75	.31	.27	.59	
A18-10	100	22-16	#10		.75	.31	.27	.59	
A87	1,000	22-16	#10		.75	.31	.27	.59	
A18-14	100	22-16	¼"		.92	.50	.37	.67	
A71	1,000	22-16	¼"		.92	.50	.37	.67	
A18-516	100	22-16	⅝"		.92	.50	.37	.67	
A72	1,000	22-16	⅝"		.92	.50	.37	.67	
A18-38	100	22-16	⅝"		.99	.54	.35	.67	
A73	1,000	22-16	⅝"		.99	.54	.35	.67	
A18-12	100	22-16	½"		1.06	.72	.38	.70	
A75	1,000	22-16	½"	1.06	.72	.38	.70		
B14-4	100	18-14	#4	ERG2002 ERG2005	.72	.25	.27	.59	.04
B132	1,000	18-14	#4		.72	.25	.27	.59	
B14-6	100	18-14	#6		.72	.25	.27	.59	
B133	1,000	18-14	#6		.72	.25	.27	.59	
B14-8	100	18-14	#8		.75	.31	.27	.59	
B86	1,000	18-14	#8		.75	.31	.27	.59	
B14-10	100	18-14	#10		.75	.31	.27	.59	
B87	1,000	18-14	#10		.75	.31	.27	.59	
B14-14	100	18-14	¼"		.93	.50	.38	.68	

CAT. NO.	PKG. QTY.	WIRE RANGE	BOLT HOLE	REC. TOOL	DIMENSIONS				STOCK THICK.		
					A	B	C	M			
B71	1,000	18-14	¼"	ERG2002 ERG2005	.93	.50	.38	.68	.03		
B14-516	100	18-14	⅝"		.93	.50	.38	.68			
B72	1,000	18-14	⅝"		.93	.50	.38	.68			
B14-38	100	18-14	⅝"		.96	.54	.35	.68			
B73	1,000	18-14	⅝"		.96	.54	.35	.68			
B14-12	100	18-14	½"		1.06	.72	.38	.70			
B75-TB	1,000	18-14	½"		1.06	.72	.38	.70			
B85	1,000	18-14	#6		.75	.31	.27	.59			
B134	1,000	18-14	#8		.72	.25	.27	.59			
C10-6-SK	50	12-10	#6		ERG2002 ERG2005	.82	.31	.27		.66	.04
C33	500	12-10	#6			.82	.31	.27		.66	
C10-8-SK	50	12-10	#8			.82	.31	.27		.66	
C77	500	12-10	#8			.82	.31	.27		.66	
C10-10	50	12-10	#10			.85	.38	.27		.66	
C26	500	12-10	#10	.85		.38	.27	.66			
C36	500	12-10	#10	.82		.31	.27	.66			
C10-14	50	12-10	¼"	.91		.50	.27	.66			
C71	500	12-10	¼"	.91		.50	.27	.66			
C10-516	50	12-10	⅝"	.98		.50	.38	.73			
C70	500	12-10	⅝"	.98		.50	.38	.73			
C72	500	12-10	⅝"	1.10		.59	.45	.80			
C10-38	50	12-10	⅝"	1.10		.59	.45	.80			
C73	500	12-10	⅝"	1.10		.59	.45	.80			
C10-12	50	12-10	½"	1.21	.72	.38	.84				
C75	500	12-10	½"	1.21	.72	.38	.84				

Thomas & Betts

United States
Tel: 901.252.8000
800.816.7809
Fax: 901.252.1354

Technical Services
Tel: 888.862.3289

Non-Insulated Ring Terminals

Non-Insulated Large Ring Terminals — Brazed Seam

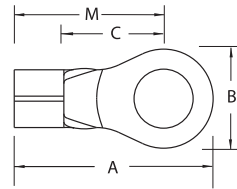

CAT. NO.	PKG. QTY.	WIRE RANGE	BOLT HOLE	REC. TOOL	DIMENSIONS				STOCK THICK.
					A	B	C	M	
D8-10	200	8	#10	TBM6S	1.13	.48	.36	.90	.06
D826	25	8	#10		1.13	.48	.36	.90	
D36	200	8	#10		1.09	.42	.34	.90	
D8-14	25	8	1/4"		1.13	.48	.36	.90	
D71	200	8	1/4"		1.13	.48	.36	.90	
D8-516	25	8	5/16"		1.32	.59	.49	1.03	
D72	200	8	5/16"		1.32	.59	.49	1.03	
D8-38	25	8	3/8"		1.32	.59	.49	1.03	
D73	200	8	3/8"		1.32	.59	.49	1.03	
D8-12	25	8	1/2"		1.49	.82	.55	1.09	
D75	200	8	1/2"		1.49	.82	.55	1.09	
E6-10	20	6	#10		1.13	.48	.36	.90	
E26	200	6	#10		1.13	.48	.36	.90	
E6-14	20	6	1/4"		1.13	.48	.36	.90	
E71	200	6	1/4"		1.13	.48	.36	.90	
E6-516	20	6	5/16"	1.32	.60	.49	1.03		

CAT. NO.	PKG. QTY.	WIRE RANGE	BOLT HOLE	REC. TOOL	DIMENSIONS				STOCK THICK.
					A	B	C	M	
E72	200	6	5/16"	TBM6S	1.32	.60	.49	1.03	.06
E6-38	20	6	3/8"		1.32	.60	.49	1.03	
E73	200	6	3/8"		1.32	.60	.49	1.03	
E6-12	20	6	1/2"		1.49	.82	.55	1.08	
E75	200	6	1/2"		1.49	.82	.55	1.08	
F4-10	20	4	#10		1.16	.48	.36	.93	
F26	200	4	#10		1.16	.48	.36	.93	
F4-14	20	4	1/4"		1.16	.48	.36	.93	
F71-TB	200	4	1/4"		1.16	.48	.36	.93	
F4-516	20	4	5/16"		1.35	.60	.49	1.06	
F72	200	4	5/16"		1.35	.60	.49	1.06	
F4-38	20	4	3/8"		1.35	.60	.49	1.06	
F73	200	4	3/8"		1.35	.60	.49	1.06	
F4-12	20	4	1/2"		1.52	.82	.55	1.11	
F75	200	4	1/2"		1.52	.82	.55	1.11	

Select the configuration you need!

Non-Insulated Large Ring Terminals — Tubular

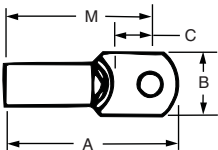

CAT. NO.	PKG. QTY.	WIRE RANGE	BOLT HOLE	REC. TOOL	DIMENSIONS				STOCK THICK.
					A	B	C	M	
D10161	200	8/8AN	#8	ERG 2005	1.15	.41	.28	.95	.04
D10361	200	8/8AN	#10		1.15	.41	.28	.95	
D10711	200	8/8AN	1/4"		1.20	.45	.36	.97	
D10721	200	8/8AN	5/16"		1.28	.56	.36	1.00	
D10731	200	8/8AN	3/8"		1.28	.56	.36	1.00	
D975*	200	8/8AN	1/2"	TBM6S	1.46	.83	.49	1.06	
E10261	200	6/6AN	#10	ERG	1.26	.49	.24	1.02	.04
E10711	200	6/6AN	1/4"	2005	1.26	.49	.27	.99	
E10721	200	6/6AN	5/16"	ERG	1.38	.60	.34	1.04	
E10731	200	6/6AN	3/8"	2008	1.38	.60	.34	1.04	
F10261	100	4/4AN	#10	TBM6S	1.37	.55	.30	1.07	
F10711	100	4/4AN	1/4"		ERG	1.37	.55	.30	1.07
F10721	100	4/4AN	5/16"		2008	1.42	.62	.34	1.08
F10731	100	4/4AN	3/8"		1.42	.62	.34	1.08	
G975*	200	4/4AN	1/2"		1.49	.83	.45	1.10	
G2-10	100	2/2AN	#10	TBM6S	1.59	.69	.40	1.26	.05
G926	100	2/2AN	#10		1.59	.69	.40	1.26	
G2-14	10	2/2AN	1/4"		1.59	.69	.40	1.26	
G971	100	2/2AN	1/4"		1.59	.69	.40	1.26	
G2-516	10	2/2AN	5/16"		1.59	.69	.40	1.26	
G972	100	2/2AN	5/16"		1.59	.69	.40	1.26	
G2-38	10	2/2AN	3/8"		1.59	.69	.40	1.26	
G973	100	2/2AN	3/8"		1.59	.69	.40	1.26	
G2-12	10	2/2AN	1/2"		1.79	.80	.49	1.36	
G975	100	2/2AN	1/2"		1.79	.80	.49	1.36	

*Brazed Seam

AN - Aircraft Wire

CAT. NO.	PKG. QTY.	WIRE RANGE	BOLT HOLE	REC. TOOL	DIMENSIONS				STOCK THICK.		
					A	B	C	M			
H10-14	10	1AN-1/0	1/4"	ERG 2008	1.65	.77	.43	1.32	.05		
H971	100	1AN-1/0	1/4"		1.65	.77	.43	1.32			
H972	100	1AN-1/0	5/16"		1.65	.77	.43	1.32			
H973	100	1AN-1/0	3/8"		1.65	.77	.43	1.32			
H975	100	1AN-1/0	1/2"		1.85	.77	.54	1.41			
J971	50	1/0AN-2/0	1/4"	TBM6S	1.94	.84	.48	1.53	.06		
J972	50	1/0AN-2/0	5/16"		1.94	.84	.48	1.53			
J20-38	10	1/0AN-2/0	3/8"		1.84	.83	.46	1.46			
J973	50	1/0AN-2/0	3/8"		1.99	.84	.53	1.58			
J974	50	1/0AN-2/0	7/16"		1.99	.89	.51	1.56			
J975	50	1/0AN-2/0	1/2"		1.99	.89	.51	1.56			
K971	50	2/0AN-3/0	1/4"		2.08	.93	.54	1.69			
K972	50	2/0AN-3/0	5/16"		2.08	.93	.54	1.69			
K30-38	5	2/0AN-3/0	3/8"		2.08	.93	.54	1.69			
K973	50	2/0AN-3/0	3/8"		2.08	.93	.54	1.69			
K974	50	2/0AN-3/0	7/16"		2.08	.93	.54	1.70			
K975	50	2/0AN-3/0	1/2"		2.08	.93	.54	1.70			
L972	50	3/0AN-4/0	5/16"		TBM6S	2.25	1.04	.57		1.77	.07
L40-38	5	3/0AN-4/0	3/8"			2.25	1.04	.57		1.77	
L973	50	3/0AN-4/0	3/8"			2.25	1.04	.57		1.77	
L974	50	3/0AN-4/0	7/16"	2.25		1.04	.57	1.77			
L975	50	3/0AN-4/0	1/2"	2.25		1.04	.57	1.77			
M972	50	4/0AN-250MCM	5/16"	2.28		1.12	.62	1.90			
M250-38	5	4/0AN-250MCM	3/8"	2.40		1.12	.65	1.91			
M973	50	4/0AN-250MCM	3/8"	2.40		1.12	.65	1.91			
M974	50	4/0AN-250MCM	7/16"	2.40		1.12	.65	1.91			
M975	50	4/0AN-250MCM	1/2"	2.40		1.12	.65	1.91			

United States
Tel: 901.252.8000
800.816.7809
Fax: 901.252.1354

Technical Services
Tel: 888.862.3289

Thomas & Betts

www.tnb.com

Sta-Kon®

Heavy-Duty Ring Terminals

Insulated Heavy-Duty Ring Terminals



Sta-Kon® Terminal Products and Tools

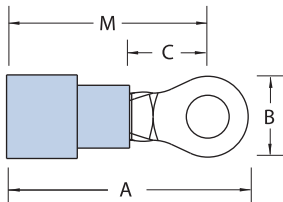

CAT. NO.	PKG. QTY.	WIRE RANGE	MAX. INS.	BOLT HOLE	REC. TOOL	DIMENSIONS				STOCK THICK.		
						A	B	C	M			
Nylon												
RBC14-6	50	16-14 Heavy-duty	.210	#6	WT2130A	.98	.25	.29	.85	.05		
RBC853	500		.210	#6		.98	.25	.29	.85			
RBC14-8	50	16-14 Heavy-duty	.210	#8		1.04	.39	.29	.85			
RBC863	500		.210	#8		1.04	.39	.29	.85			
RBC14-10	50	16-14 Heavy-duty	.210	#10		1.04	.39	.29	.85			
RBC873	500		.210	#10		1.04	.39	.29	.85			
RBC14-14	50	16-14 Heavy-duty	.210	1/4"		1.10	.51	.29	.85			
RBC713	500		.210	1/4"		1.10	.51	.29	.85			
RBC14-516	50	16-14 Heavy-duty	.210	5/16"		1.21	.54	.38	.94			
RBC723	500		.210	5/16"		1.21	.54	.38	.94			
RBC14-38	50	16-14 Heavy-duty	.210	3/8"		1.26	.63	.38	.94			
RBC793	500		.210	3/8"		1.26	.63	.38	.94			
RBC14-12	50	16-14 Heavy-duty	.210	1/2"		1.49	.76	.54	1.11			
RBC753	500		.210	1/2"		1.49	.76	.54	1.11			
Vinyl												
14RBC-6	50	16-14 Heavy-duty	.210	#6		1.06	.25	.29	.93			
RBC857	500		.210	#6	1.06	.25	.29	.93				
14RBC-8	50	16-14 Heavy-duty	.210	#8	1.13	.39	.29	.93				
RBC867	500		.210	#8	1.13	.39	.29	.93				
14RBC-10	50	16-14 Heavy-duty	.210	#10	1.13	.39	.29	.93				
RBC877	500		.210	#10	1.13	.39	.29	.93				
14RBC-14	50	16-14 Heavy-duty	.210	1/4"	1.19	.51	.29	.93				
RBC717	500		.210	1/4"	1.19	.51	.29	.93				
14RBC-516	50	16-14 Heavy-duty	.210	5/16"	1.29	.54	.38	1.03				
RBC727	500		.210	5/16"	1.29	.54	.38	1.03				
14RBC-38	50	16-14 Heavy-duty	.210	3/8"	1.34	.63	.38	1.03				
RBC797	500		.210	3/8"	1.34	.63	.38	1.03				
14RBC-12	50	16-14 Heavy-duty	.210	1/2"	1.57	.76	.54	1.19				
RB757	500		.210	1/2"	1.57	.76	.54	1.19				

The heavy-duty terminal solution!



Non-Insulated Heavy-Duty Terminals

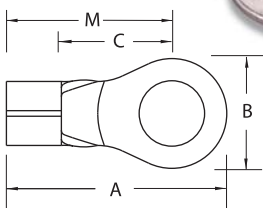

CAT. NO.	PKG. QTY.	WIRE RANGE	BOLT HOLE	REC. TOOL	DIMENSIONS				STOCK THICK.
					A	B	C	M	
BC14-6	50	16-14 Heavy-duty	#6	ERG2002 ERG2005	.81	.25	.29	.68	.05
BC85	500		#6		.81	.25	.29	.68	
BC14-8	50	16-14 Heavy-duty	#8		.87	.39	.29	.68	
BC86	500		#8		.87	.39	.29	.68	
BC14-10	50	16-14 Heavy-duty	#10		.87	.39	.29	.68	
BC87	500		#10		.87	.39	.29	.68	
BC14-14	50	16-14 Heavy-duty	1/4"		.93	.51	.29	.68	
BC71	500		1/4"		.93	.51	.29	.68	
BC14-516	50	16-14 Heavy-duty	5/16"		1.04	.54	.38	.77	
BC72	500		5/16"		1.04	.54	.38	.77	
BC14-38	50	16-14 Heavy-duty	3/8"		1.09	.63	.38	.77	
BC79	500		3/8"		1.09	.63	.38	.77	
BC14-12	50	16-14 Heavy-duty	1/2"		1.32	.76	.54	.94	
BC75	500		1/2"		1.32	.76	.54	.94	

Thomas & Betts

United States
Tel: 901.252.8000
800.816.7809
Fax: 901.252.1354

Technical Services
Tel: 888.862.3289

High-Temperature Non-Insulated & Tefzel® Insulated Ring Terminals

Terminals for nichrome wire NW Series.

High-Temperature Non-Insulated Ring — 1200° F Max.

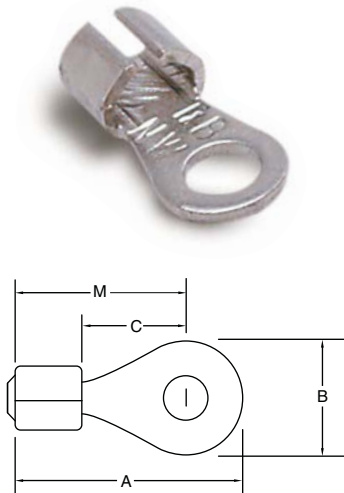

CAT. NO.	PKG. QTY.	WIRE RANGE	WT./LBS. PER 1,000	BOLT HOLE	REC. TOOL	DIMENSIONS				STOCK THICK.
						A	B	C	M	
NW21	1,000	24-22	1.5	#6	WT1377	.59	.31	.28	.44	.032
NW22	1,000	24-22	1.5	#8		.59	.31	.28	.44	
NW23	1,000	24-22	1.5	#10		.59	.31	.28	.44	
NW18-10	100	20-18	2.5	#10		.63	.31	.28	.38	.040
NW52	1,000	20-18	2.5	#8		.63	.31	.28	.38	
NW81	1,000	16-14	2.5	#6		.66	.31	.28	.51	
NW14-8	100	16-14	2.5	#8		.66	.31	.28	.51	
NW14-10	100	16-14	2.5	#10		.66	.31	.28	.51	
NW83	1,000	16-14	2.5	#10		.66	.31	.28	.51	
NW14-12	100	16-14	2.5	#12*		.66	.31	.28	.51	
NW84	1,000	16-14	2.5	#12*	.66	.31	.28	.51		
NW10-8	50	12-10	3	#8	.66	.31	.28	.51	.040	
NW10-10	50	12-10	3	#10	.66	.31	.28	.51		
NW10-12	50	12-10	3	#12*	.66	.31	.28	.51		

* #12 stud is smaller than 1/4" stud.

Tefzel® Insulated Ring — Insulation Grip



CAT. NO.	PKG. QTY.	WIRE RANGE	MAX INS.	BOLT HOLE	REC. TOOL	DIMENSIONS				STOCK THICK.
						A	B	C	M	
RAT853	1,000	22-18	.140	#6	WT145C	.81	.25	.25	.69	.03
RAT863	1,000	22-18	.140	#8		.84	.31	.25	.69	
RAT873	1,000	22-18	.140	#10		.84	.31	.25	.69	
RAT713	1,000	22-18	.140	1/4"		1.07	.46	.31	.84	
RBT853	1,000	16-14	.170	#6	WT145C	.84	.31	.25	.69	.03
RBT863	1,000	16-14	.170	#8		.84	.31	.25	.69	
RBT873	1,000	16-14	.170	#10		.84	.31	.25	.69	
RBT713	1,000	16-14	.170	1/4"		1.08	.46	.31	.81	
RCT333	500	12-10	.210	#6	WT145C	1.00	.37	.27	.81	.04
RCT863	500	12-10	.210	#8		1.00	.37	.27	.81	
RCT363	500	12-10	.210	#10		1.00	.37	.27	.81	
RCT713	500	12-10	.210	1/4"		1.11	.52	.32	.85	
RCT703	500	12-10	.210	5/16"		1.23	.52	.31	.96	
RCT733	500	12-10	.210	3/8"		1.29	.58	.35	1.00	

Tefzel® is a registered trademark of DuPont.

Nylon-Insulated and Non-Insulated Rectangular Ring Terminals

Nylon-Insulated Rectangular Rings

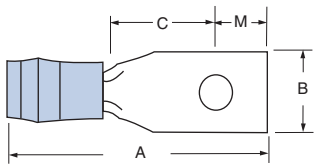

CAT. NO.	PKG. QTY.	BOLT HOLE	WIRE RANGE	REC. TOOL	DIMENSIONS				BU-SHIPS TONGUE SHAPE	STOCK THICK.		
					A	B	C	M				
RA486	1,000	#4	22-18	ERG2001	.796	.237	.237	.143	L86P-1	.03		
RA485	1,000	#4	22-18		1.015	.237	.404	.195	L85P-1			
RA483	1,000	#5	22-18		.859	.277	.277	.143	L83P-1			
RA484	1,000	#6	22-18		1.015	.237	.404	.195	L84P-1			
RA481	1,000	#6	22-18		1.109	.302	.465	.227	L81P-1			
RA482	1,000	#8	22-18		1.109	.302	.465	.227	L82P-1			
RA480**	1,000	#8	22-18		1.359	.390	.621	.310	L80P-1			
RB486	1,000	#4	16-14		.796	.237	.237	.143	L86P-2			
RB485	1,000	#4	16-14		1.015	.237	.404	.195	L85P-2			
RB483	1,000	#5	16-14		.859	.277	.277	.143	L83P-2			
RB484	1,000	#6	16-14		1.015	.237	.404	.195	L84P-2			
RB481	1,000	#6	16-14		1.109	.302	.465	.227	L81P-2			
RB482	1,000	#8	16-14		1.109	.302	.465	.227	L82P-2			
RB480**	1,000	#8	16-14		1.359	.390	.621	.310	L80P-2			
RC486	500	#4	12-10		ERG2005	.984	.237	.237	.143		L86P-3	.04
RC485	500	#4	12-10			1.187	.237	.404	.195		L85P-3	
RC483	500	#5	12-10	1.046		.277	.277	.143	L83P-3			
RC484	500	#6	12-10	1.203		.237	.404	.195	L84P-3			
RC481	500	#6	12-10	1.281		.302	.465	.227	L81P-3			
RC482	500	#8	12-10	1.281		.302	.465	.227	L82P-3			
RC480**	500	#8	12-10	1.531		.390	.621	.310	L80P-3			

** Not available on tape.

NOTE: RA, RB, RC486 for use with BU-Ships terminal board types 26TB. RA, RB, RC485 for use with 25TB and 27TB. RA, RB, RC483 for use with 8TB. RA, RB, RC484 for use with 10TB and 11TB. RA, RB, RC481 for use with 6TB, 7TB and 9TB. RA, RB, RC482 for use with 15TB. RA, RB, RC480 for use with 3TB, 4TB, 5TB, 16TB, 17TB and 18TB.

NOTE:

22-18 ga. = 1-2 Navy
16-14 ga. = 2½-4 Navy
12-10 ga. = 6-9 Navy

Non-Insulated Rectangular Rings

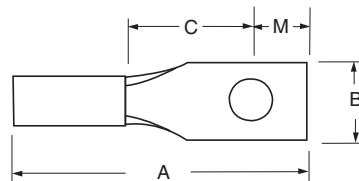

CAT. NO.	PKG. QTY.	BOLT HOLE	WIRE RANGE	REC. TOOL	DIMENSIONS				BU-SHIPS TONGUE SHAPE	STOCK THICK.
					A	B	C	M		
A486	1,000	#4	22-18	ERG2002	.65	.237	.237	.143	L86	.03
A485	1,000	#4	22-18		.87	.237	.404	.195	L85	
A483	1,000	#5	22-18		.70	.277	.277	.143	L83	
A484	1,000	#6	22-18		.87	.237	.404	.195	L84	
A481	1,000	#6	22-18		.96	.302	.465	.227	L81	
A482	1,000	#8	22-18		.96	.302	.465	.227	L82	
A480**	1,000	#8	22-18		1.21	.390	.621	.310	L80	
B486	1,000	#4	16-14		.65	.237	.237	.143	L86	
B485	1,000	#4	16-14	.87	.237	.404	.195	L85		
B483	1,000	#5	16-14	.70	.277	.277	.143	L83		
B484	1,000	#6	16-14	.87	.237	.404	.195	L84		
B481	1,000	#6	16-14	.96	.302	.465	.227	L81		
B482	1,000	#8	16-14	.96	.302	.465	.227	L82		
B480**	1,000	#8	16-14	1.21	.390	.621	.310	L80		
C486	500	#4	12-10	ERG2005	.73	.237	.237	.143	L86	.04
C485	500	#4	12-10		.90	.237	.404	.195	L85	
C483	500	#5	12-10		.76	.277	.277	.143	L83	
C484	500	#6	12-10		.94	.237	.404	.195	L84	
C481	500	#6	12-10		1.03	.302	.465	.227	L81	
C482	500	#8	12-10		1.03	.302	.465	.227	L82	
C480**	500	#8	12-10		1.27	.390	.621	.310	L80	

** Not available on tape.

NOTE: A, B, C486 for use with Bu-Ships terminal board types 26TB. A, B, C485 for use with 25TB, 27TB. A, B, C483 for use with 8TB. A, B, C484 for use with 10TB and 11TB. A, B, C481 for use with 6TB, 7TB and 9TB. A, B, C482 for use with 15TB. A, B, C480 for use with 3TB, 5TB, 16TB, 17TB and 18TB.

NOTE:

22-18 ga. = 1-2 Navy
16-14 ga. = 2½-4 Navy
12-10 ga. = 6-9 Navy

Non-Insulated Flag

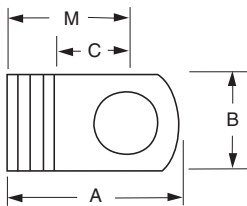
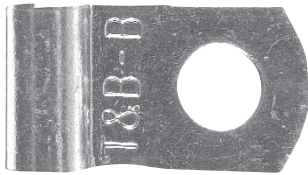

CAT. NO.	PKG. QTY.	WIRE RANGE	BOLT HOLE	REC. TOOL	DIMENSIONS				STOCK THICK.		
					A	B	C	M			
AB14-6A	100	22-14	#6	ERG2004	.55	.31	.22	.39	.03		
AB51	1,000	22-14	#6		.55	.31	.22	.39			
AB14-8A	100	22-14	#8		.55	.31	.22	.39			
AB52	1,000	22-14	#8		.55	.31	.22	.39			
AB14-10A	100	22-14	#10		.55	.31	.22	.39			
AB53	1,000	22-14	#10		.55	.31	.22	.39			
C51	500	12-10	#6		.66	.31	.25	.48		.04	
C10-8A	50	12-10	#8		.66	.31	.25	.48			
C52	500	12-10	#8		.66	.31	.25	.48			
C10-10A	50	12-10	#10		.66	.31	.25	.48			
C53	500	12-10	#10	.66	.31	.25	.48				
D236	200	8	#10	WT129	.83	.50	.25	.59	.06		
D226	200	8	#10		.90	.50	.29	.64			
D271	200	8	¼"		.92	.50	.33	.68			
E226	200	6	#10		.93	.50	.29	.69			
E271	200	6	¼"		.99	.50	.33	.73			
E272	200	6	⅝"		1.05	.50	.41	.81			
F226	200	4	#10		1.07	.56	.33	.80		.07	
F271	200	4	¼"		1.10	.63	.33	.80			
F272	200	4	⅝"		1.18	.63	.41	.88			
F273	200	4	¾"		1.20	.63	.43	.90			
G671	100	2	¼"	13642M	1.20	.63	.33	.89	.08		
G672	100	2	⅝"		1.28	.63	.41	.97			
G673	100	2	¾"		1.32	.63	.46	1.02			
H672	50	1/0	⅝"		1.31	.63	.41	1.01		.10	
H673	50	1/0	¾"		1.36	.63	.46	1.06			
J672	50	2/0	⅝"		1.46	.75	.41	1.10			
J673	50	2/0	¾"		1.51	.75	.46	1.15			
J675	50	2/0	½"		1.67	.75	.55	1.24			
K672	50	3/0	⅝"		1.59	.81	.41	1.19			.11
K673	50	3/0	¾"		1.64	.81	.46	1.24			
K675	50	3/0	½"	1.76	.81	.55	1.34				
M673	50	250MCM	¾"	1.89	1.0	.46	1.43	.13			
M675	50	250MCM	½"	1.99	1.0	.55	1.52				

Sta-Kon Terminal Products and Tools

Nylon-Insulated Fork Terminals

- Fork terminals enable easy installation because the mounting screw does not have to be completely removed
- Braze seam barrel is serrated for high pull-out value. Terminal is high conductivity electrolytic copper, electro-tin plated. Insulation is color-coded
- Vinyl insulated fork terminals have extra-long PVC insulation sleeve for protection and stress relief at wire's flex point
- Suffix "X" indicates an expanded insulation support, meaning a wider wire entry to accommodate heavy wall insulation



Nylon-Insulated Fork

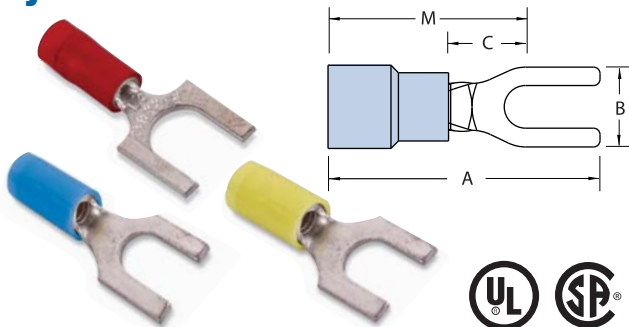

CAT. NO.	PKG. QTY.	WIRE RANGE	MAX. INS.	BOLT HOLE	REC. TOOL	DIMENSIONS				STOCK THICK.
						A	B	C	M	
RA18-6F	100	22-16	.136	#6	ERG 2001	.83	.25	.25	.71	.02
RA1103	1,000	22-16	.136	#6		.83	.25	.25	.71	
RA18-8F	100	22-16	.136	#8		.86	.31	.25	.71	
RA1123	1,000	22-16	.136	#8		.86	.31	.25	.71	
RA18-10F	100	22-16	.136	#10		.86	.31	.25	.71	
RA1153	1,000	22-16	.136	#10		.86	.31	.25	.71	
RA18-14F	100	22-16	.136	1/4"		.95	.44	.31	.70	
RA1163	1,000	22-16	.136	1/4"		.95	.44	.31	.70	
RB14-6F	100	18-14	.162	#6		.87	.31	.25	.71	.03
RB1113	1,000	18-14	.162	#6		.87	.31	.25	.71	
RB14-8F	100	18-14	.162	#8		.87	.31	.25	.71	
RB1123	1,000	18-14	.162	#8		.87	.31	.25	.71	
RB14-10F	100	18-14	.162	#10		.87	.38	.25	.71	
RB1153	1,000	18-14	.162	#10		.87	.38	.25	.71	
RB14-14F	100	18-14	.162	1/4"		.95	.44	.28	.74	
RB1163	1,000	18-14	.162	1/4"	.95	.44	.28	.74		
RB1103	1,000	18-14	.162	#6	.74	.28	.16	.60	.04	
RB1124	1,000	18-14	.190	#8	.95	.31	.25	.79		
RB1154	1,000	18-14	.190	#10	.95	.31	.25	.79		
RC10-6F	50	12-10	.210	#6	.97	.31	.27	.81		
RC1113	500	12-10	.210	#6	.97	.31	.27	.81		
RC10-8F	50	12-10	.210	#8	1.00	.37	.27	.81		
RC1123	500	12-10	.210	#8	1.00	.37	.27	.81		
RC10-10F	50	12-10	.210	#10	1.00	.37	.27	.81		
RC1153	500	12-10	.210	#10	1.00	.37	.27	.81		
RC10-14F	50	12-10	.210	1/4"	1.12	.50	.27	.86		
RC1163	500	12-10	.210	1/4"	1.12	.50	.27	.86		
RC1124	1,000	12-10	.250	#8	1.10	.37	.27	.91		
RC1154	1,000	12-10	.250	#10	1.10	.37	.27	.91		

Nylon-Insulated Locking Fork

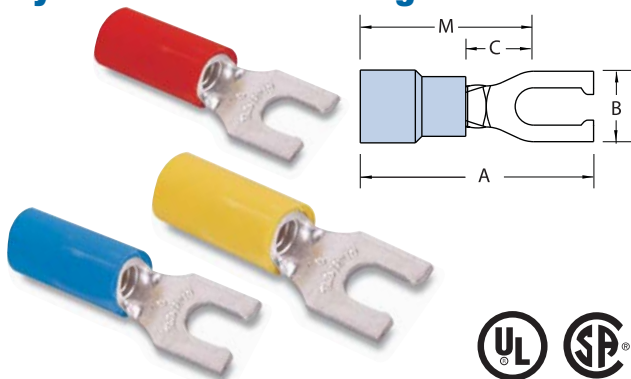

CAT. NO.	PKG. QTY.	WIRE RANGE	MAX. INS.	BOLT HOLE	REC. TOOL	DIMENSIONS				STOCK THICK.
						A	B	C	M	
RA18-6FL	100	22-16	.136	#6	ERG 2001	.86	.25	.25	.71	.02
RA2213	1,000	22-16	.136	#6		.86	.25	.25	.71	
RA18-8FL	100	22-16	.136	#8		.86	.29	.25	.71	
RA2243	1,000	22-16	.136	#8		.86	.29	.25	.71	
RA18-10FL	100	22-16	.136	#10		.86	.29	.25	.71	
RA2253	1,000	22-16	.136	#10		.86	.29	.25	.71	
RB14-6FL	100	18-14	.162	#6		.87	.25	.25	.71	.03
RB2213	1,000	18-14	.162	#6		.87	.25	.25	.71	
RB2214	1,000	18-14	.190	#6		.95	.25	.25	.79	
RB14-8FL	100	18-14	.162	#8		.87	.29	.25	.71	
RB2233	1,000	18-14	.162	#8		.87	.29	.25	.71	
RB14-10FL	100	18-14	.162	#10		.87	.29	.25	.71	
RB2253	1,000	18-14	.162	#10		.87	.29	.25	.71	
RB2254	1,000	18-14	.190	#10		.95	.29	.25	.71	
RC10-6FL	50	12-10	.210	#6		.97	.31	.27	.81	.04
RC2203	500	12-10	.210	#6	.97	.31	.27	.81		
RC2204	1,000	12-10	.250	#6	1.07	.31	.27	.91		
RC10-8FL	50	12-10	.210	#8	1.00	.37	.27	.81		
RC2213	500	12-10	.210	#8	1.00	.37	.27	.81		
RC10-10FL	50	12-10	.210	#10	1.00	.37	.27	.81		
RC2223	500	12-10	.210	#10	1.00	.37	.27	.81		
RC2224	1,000	12-10	.250	#10	1.10	.37	.27	.91		
RC10-14FL	50	12-10	.210	1/4"	1.12	.50	.32	.86		
RC2233	500	12-10	.210	1/4"	1.12	.50	.32	.86		

Vinyl-Insulated Fork Terminals

Nylon-Insulated Fork — Flanged Tongue

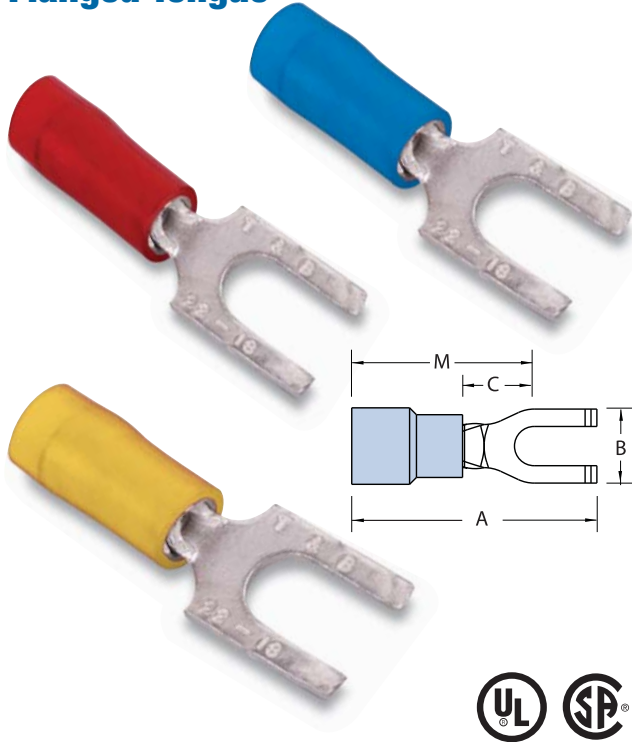

CAT. NO.	PKG. QTY.	WIRE RANGE	MAX. INS.	BOLT HOLE	REC. TOOL	DIMENSIONS				STOCK THICK.	
						A	B	C	M		
RA18-6FS	100	22-16	.136	#6	ERG 2001	.75	.28	.16	.62	.02	
RA1203	1,000	22-16	.136	#6		.75	.28	.16	.62		
RA18-8FS	100	22-16	.136	#8		.89	.31	.23	.65		
RA1223	1,000	22-16	.136	#8		.89	.31	.23	.65		
RA18-10FS	100	22-16	.136	#10		.93	.38	.26	.68		
RA1253	1,000	22-16	.136	#10		.93	.38	.26	.68		
RB14-6FS	100	18-14	.162	#6		.74	.28	.16	.60		.03
RB1203	1,000	18-14	.162	#6		.74	.28	.16	.60		
RB14-8FS	100	18-14	.162	#8		.89	.31	.23	.66		
RB1223	1,000	18-14	.162	#8		.89	.31	.23	.66		
RB14-10FS	100	18-14	.162	#10	.94	.38	.27	.69			
RB1253	1,000	18-14	.162	#10	.94	.38	.27	.69			
RB1204	1,000	18-14	.190	#6	.79	.28	.16	.67			
RB1224	1,000	18-14	.190	#8	.94	.31	.23	.71			
RC10-8FS	50	12-10	.210	#8	.97	.34	.23	.73	.04		
RC1223	500	12-10	.210	#8	.97	.34	.23	.73			
RC10-10FS	50	12-10	.210	#10	1.00	.38	.26	.74			
RC1253	500	12-10	.210	#10	1.00	.38	.26	.74			
RC1224	1,000	12-10	.250	#8	1.08	.34	.23	.80			
RC1254	1,000	12-10	.250	#10	1.12	.38	.26	.86			

Vinyl-Insulated Fork

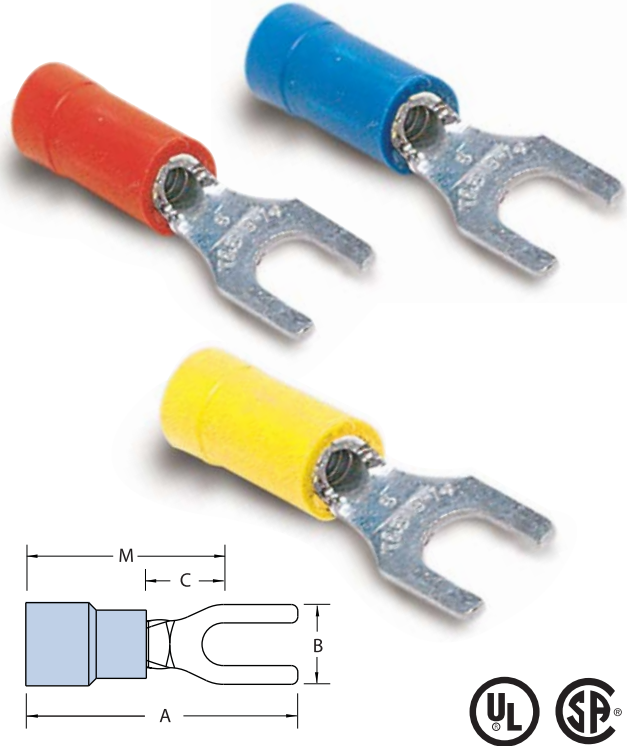

CAT. NO.	PKG. QTY.	WIRE RANGE	MAX. INS.	BOLT HOLE	REC. TOOL	DIMENSIONS				STOCK THICK.	
						A	B	C	M		
18RA-6F	100	22-16	.150	#6	ERG 2001	.94	.25	.27	.81	.02	
18A1167	1,000	22-16	.150	#6		.94	.25	.27	.81		
18RA-8F	100	22-16	.150	#8		.97	.31	.27	.81		
RA1147	1,000	22-16	.150	#8		.97	.31	.27	.81		
18RA-10F	100	22-16	.150	#10		.97	.31	.27	.81		
RA1157	1,000	22-16	.150	#10		.97	.31	.27	.81		
14RB-6F	100	18-14	.170	#6		.97	.31	.27	.81		.03
RB647	1,000	18-14	.170	#6		.97	.31	.27	.81		
14RB-6FS	100	18-14	.170	#6		.89	.30	.25	.75		
14RB-8F	100	18-14	.170	#8		.97	.31	.27	.81		
RB657	1,000	18-14	.170	#8	.97	.31	.27	.81			
14RB-10F	100	18-14	.170	#10	.97	.31	.27	.81			
RB1157	1,000	18-14	.170	#10	.97	.31	.27	.81			
14RB-14F	100	18-14	.170	1/4"	1.11	.44	.38	.89			
RB1717	1,000	18-14	.170	1/4"	1.11	.44	.38	.89			
10RC-6F	50	12-10	.210	#6	ERG 2001	1.09	.31	.27	.90	.04	
RC1337	500	12-10	.210	#6		1.09	.31	.27	.90		
10RC-8F	50	12-10	.210	#8		1.09	.38	.27	.90		
RC1147	500	12-10	.210	#8		1.09	.38	.27	.90		
10RC-10F	50	12-10	.210	#10		1.09	.38	.27	.90		
RC1157	500	12-10	.210	#10		1.09	.38	.27	.90		
10RC-14F	50	12-10	.210	1/4"		1.15	.50	.37	.90		
RC1167	500	12-10	.210	1/4"		1.15	.50	.37	.90		

Sta-Kon®

Vinyl-Insulated Fork Terminals

Vinyl-Insulation Fork — Expanded Insulation

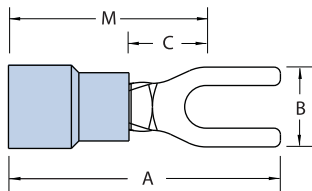

CAT. NO.	PKG. QTY.	WIRE RANGE	MAX. INS.	BOLT HOLE	REC. TOOL	DIMENSIONS				STOCK THICK.
						A	B	C	M	
18RA-6FX	100	22-16	.170	#6	ERG 2001	.94	.25	.27	.81	.02
RA1167-170	1,000	22-16	.170	#6		.94	.25	.27	.81	
18RA-8FX	100	22-16	.170	#8		.97	.31	.27	.81	
RA1147-170	1,000	22-16	.170	#8		.97	.31	.27	.81	
18RA-10FX	100	22-16	.170	#10		.97	.31	.27	.81	
RA1157-170	1,000	22-16	.170	#10		.97	.31	.27	.81	
14RB-6FX	100	18-14	.200	#6		.97	.31	.27	.81	.03
RB647-200	1,000	18-14	.200	#6		.97	.31	.27	.81	
14RB-8FX	100	18-14	.200	#8		.97	.31	.27	.81	
RB657-200	1,000	18-14	.200	#8		.97	.31	.27	.81	
14RB-10FX	100	18-14	.200	#10	.97	.31	.27	.81		
RB1157-200	1,000	18-14	.200	#10	.97	.31	.27	.81		
10RC-8FX	50	12-10	.250	#8	ERG 2001	1.11	.38	.27	.90	.04
RC1147-250	500	12-10	.250	#8		1.11	.38	.27	.90	
10RC-10FX	50	12-10	.250	#10		1.11	.38	.27	.90	
RC1157-250	500	12-10	.250	#10		1.11	.38	.27	.90	
10RC-14FX	50	12-10	.250	1/4"		1.17	.50	.37	.90	

Vinyl-Insulated Locking Fork

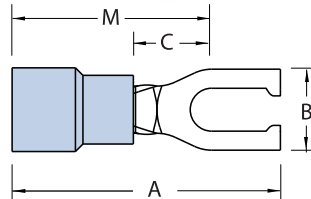

CAT. NO.	PKG. QTY.	WIRE RANGE	MAX. INS.	BOLT HOLE	REC. TOOL	DIMENSIONS				STOCK THICK.
						A	B	C	M	
18RA-6FL	100	22-16	.150	#6	ERG 2001	.97	.25	.25	.81	.02
RA2217	1,000	22-16	.150	#6		.97	.25	.25	.81	
RA2227	1,000	22-16	.155	#6		.97	.29	—	.81	
18RA-8FL	100	22-16	.150	#8		.97	.29	.25	.81	
RA2247	1,000	22-16	.150	#8		.97	.29	.25	.81	
18RA-10FL	100	22-16	.150	#10		.97	.29	.25	.81	
RA2257	1,000	22-16	.150	#10		.97	.29	.25	.81	
14RB-6FL	100	18-14	.170	#6		.97	.25	.27	.81	.03
RB2207	1,000	18-14	.170	#6		.97	.25	.27	.81	
RB2217	1,000	18-14	.170	#6		.97	.29	.27	.81	
14RB-8FL	100	18-14	.170	#8	.97	.29	.27	.81		
RB2237	1,000	18-14	.170	#8	.97	.29	.27	.81		
14RB-10FL	100	18-14	.170	#10	.97	.29	.27	.81		
RB2257	1,000	18-14	.170	#10	.97	.29	.27	.81		
10RC-6FL	50	12-10	.220	#6	ERG 2001	1.09	.31	.27	.90	.04
RC2207	500	12-10	.220	#6		1.09	.31	.27	.90	
10RC-8FL	50	12-10	.220	#8		1.09	.37	.27	.90	
RC2217	500	12-10	.220	#8		1.09	.37	.27	.90	
10RC-10FL	50	12-10	.220	#10		1.09	.37	.27	.90	
RC2227	500	12-10	.220	#10		1.09	.37	.27	.90	
10RC-14FL	50	12-10	.220	1/4"		1.09	.49	.27	.90	
RC2237	500	12-10	.220	1/4"		1.09	.49	.27	.90	

Sta-Kon® Terminal Products and Tools

Thomas & Betts

United States
Tel: 901.252.8000
800.816.7809
Fax: 901.252.1354

Technical Services
Tel: 888.862.3289

Vinyl-Insulated & Non-Insulated Fork Terminals

Vinyl-Insulated Locking Fork— Expanded Insulation

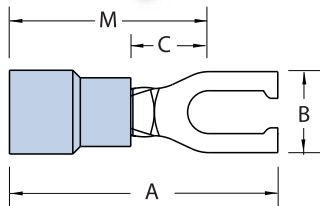

CAT. NO.	PKG. QTY.	WIRE RANGE	MAX. INS.	BOLT HOLE	REC. TOOL	DIMENSIONS				STOCK THICK.
						A	B	C	M	
18RA-6FLX	100	22-16	.170	#6	ERG 2001	.97	.25	.25	.81	.02
18RA-8FLX	100	22-16	.170	#8		.97	.29	.25	.81	
18RA-10FLX	100	22-16	.170	#10		.97	.29	.25	.81	
RA2257-170	1,000	22-16	.170	#10		.97	.29	.25	.81	.03
14RB-6FLX	100	18-14	.200	#6		.97	.31	.27	.81	
RB2207-200	1,000	18-14	.200	#6		.97	.31	.27	.81	
RB2217-200	1,000	18-14	.200	#6		.97	.29	.27	.81	
14RB-8FLX	100	18-14	.200	#8		.97	.31	.27	.81	
RB2237-200	1,000	18-14	.200	#8		.97	.31	.27	.81	
14RB-10FLX	100	18-14	.200	#10		.97	.31	.27	.81	
RB2257-200	1,000	18-14	.200	#10	.97	.31	.27	.81		
10RC-6FLX	50	12-10	.250	#6	ERG 2002	1.07	.31	.27	.91	.04
RC2207-250	500	12-10	.250	#6		1.07	.31	.27	.91	
10RC-8FLX	50	12-10	.250	#8		1.10	.37	.27	.91	
10RC-10FLX	50	12-10	.250	#10		1.10	.37	.27	.91	
RC2227-250	500	12-10	.250	#10		1.10	.37	.27	.91	
10RC-14FLX	50	12-10	.250	1/4"		1.22	.50	.32	.96	

Non-Insulated Fork

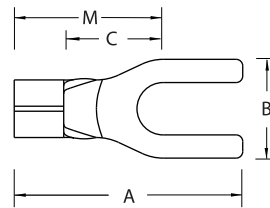

CAT. NO.	PKG. QTY.	WIRE RANGE	BOLT HOLE	REC. TOOL	DIMENSIONS				STOCK THICK.
					A	B	C	M	
A18-6F	100	22-16	#6	ERG 2002	.72	.25	.27	.59	.02
A116	1,000	22-16	#6		.72	.25	.27	.59	
A18-8F	100	22-16	#8		.75	.31	.27	.59	
A114	1,000	22-16	#8		.75	.31	.27	.59	
A18-10F	100	22-16	#10		.75	.31	.27	.59	
A115-TB	1,000	22-16	#10	.75	.31	.27	.59	.03	
B14-6F	100	18-14	#6	.75	.31	.27	.59		
B64	1,000	18-14	#6	.75	.31	.27	.59		
B19	1,000	18-14	#6	.66	.25	.13	.50		
B14-8F	100	18-14	#8	.75	.31	.27	.59		
B65-TB	1,000	18-14	#8	.75	.31	.27	.59		
B14-10F	100	18-14	#10	.75	.31	.27	.59		
B115	1,000	18-14	#10	.75	.31	.27	.59	.04	
B14-14F	100	18-14	1/4"	.90	.44	.38	.68		
C10-6F	50	12-10	#6	ERG 2005	.77	.31	.27		.63
C133	500	12-10	#6		.77	.31	.27		.63
C10-8F	50	12-10	#8		.82	.38	.27		.63
C114	500	12-10	#8		.82	.38	.27		.63
C10-10F	50	12-10	#10		.82	.38	.27		.63
C115	500	12-10	#10		.82	.38	.27		.63
C10-14F	50	12-10	1/4"		.98	.50	.37		.73
C116-TB	500	12-10	1/4"		.98	.50	.37		.73

Non-Insulated Locking Fork Terminals

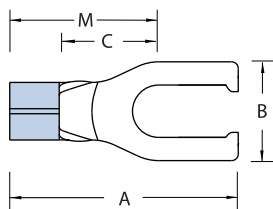

Pin Terminals



Non-Insulated Pin Terminal

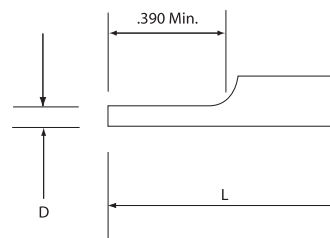

Insulated Pin Terminal

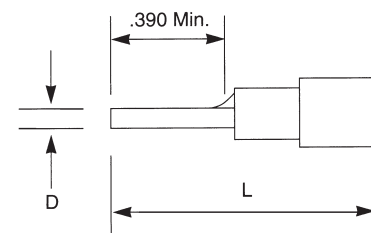

Sta-Kon® Terminal Products and Tools



CAT. NO.	PKG. QTY.	WIRE RANGE	BOLT HOLE	REC. TOOL	DIMENSIONS				STOCK THICK.
					A	B	C	M	
A18-6FL	100	22-16	#6	ERG 2002	.75	.25	.27	.59	.02
A221	1,000	22-16	#6		.75	.25	.27	.59	
A18-8FL	100	22-16	#8		.75	.29	.27	.59	
A224	1,000	22-16	#8		.75	.29	.27	.59	
A18-10FL	100	22-16	#10		.75	.29	.27	.59	
A225	1,000	22-16	#10	.75	.29	.27	.59	.03	
B14-6FL	100	18-14	#6	.75	.25	.27	.59		
B220	1,000	18-14	#6	.75	.25	.27	.59		
B14-8FL	100	18-14	#8	.75	.29	.27	.59		
B223	1,000	18-14	#8	.75	.29	.27	.59		
B14-10FL	100	18-14	#10	.75	.29	.27	.59	.04	
B225	1,000	18-14	#10	.75	.29	.27	.59		
C10-6FL	50	12-10	#6	.85	.31	.27	.66		
C220-TB	500	12-10	#6	.85	.31	.27	.66		
C10-8FL	50	12-10	#8	.85	.37	.27	.66		
C221	500	12-10	#8	.85	.37	.27	.66	.04	
C10-10FL	50	12-10	#10	.85	.37	.27	.66		
C222	500	12-10	#10	.85	.37	.27	.66		
C10-14FL	50	12-10	1/4"	.85	.49	.27	.66		



CAT. NO.	PKG. QTY.	WIRE RANGE	D (DIA.)	L	REC. TOOLS	STOCK THICK.	
Non-Insulated							
A47PT	1,000	22-18	.075	.63	ERG2002	.02	
B47PT	1,000	16-14	.075	.63		.03	
C55PT	500	12-10	.106	.76		.04	
Vinyl							
18RA-47PT	100	22-18	.075	.85	ERG2001	.02	
RA47PT	1,000	22-18	.075	.85			
14RB-47PT	100	16-14	.075	.87		.03	
RB47PT	1,000	16-14	.075	.87			
10RC-55PT	50	12-10	.106	1.04		.04	
RC55PT	500	12-10	.106	1.04			
Nylon							
RA18-47PT	100	22-18	.075	.85		ERG2001	.02
RA147PT	1,000	22-18	.075	.85			
RB14-47PT	100	16-14	.075	.87			.03
RB147PT	1,000	16-14	.075	.87			
RC10-55PT	50	12-10	.106	1.04	.04		
RC155PT	500	12-10	.106	1.04			

Splices

Butt Splices

- Wires are butted together and crimped at each end of the splice
- Available either non-insulated or insulated with nylon or PVC
- Nylon insulated splices meet or exceed the requirements of MIL-T-7928
- Color-coded according to wire size

Parallel Splices

- Wires are laid side by side in the connector, and the connection is made in one crimp
- Offer advantages in simplicity of installation and small size
- One crimp completes the splice



Vinyl-Insulated Splices — Butt Type — Expanded Insulation

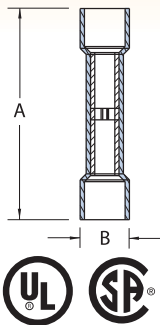

CAT. NO.	PKG. QTY.	WIRE RANGE	MAX. INS.	REC. TOOL	DIMENSIONS	
					A	B
2RA18X	100	22-18	.170	ERG2001	1.13	.25
RAA217-170	1,000	22-18	.170		1.13	.25
RAA217	1,000	22-18	.155		1.13	.23
2RB14X	100	16-14	.200		1.13	.26
RBB217-200	1,000	16-14	.200		1.13	.26
RBB217	1,000	16-14	.180		1.13	.23
2RC10X	50	12-10	.250		1.31	.31
RCC217-250	500	12-10	.250		1.31	.31
RCC217	1,000	12-10	.210		1.31	.29

Nylon-Insulated Aircraft Splices

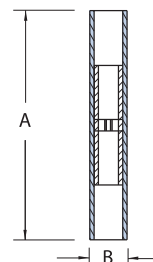

CAT. NO.	PKG. QTY.	WIRE RANGE	REC. TOOL	DIMENSIONS	
				A	B
2RZZ	50	26-22	ERG2006	1.22	.15
2RAA	50	22-18	ERG2001	1.52	.25
RAA23	500	22-18		1.52	.25
2RBB	50	16-14		1.52	.28
RBB23	500	16-14		1.52	.28
2RCC	25	12-10		1.54	.35
RCC23	250	12-10		1.54	.35

Nylon-Insulated Butt Splices

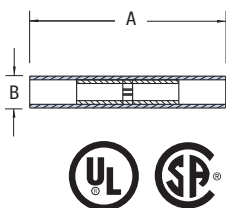

CAT. NO.	PKG. QTY.	MAX INS. DIA.	WIRE RANGE	REC. TOOL	DIMENSIONS	
					A	B
2RA18	100	.115	22-18	ERG2001	1.19	.18
RAA21	1,000	.115	22-18		1.19	.18
2RB14	100	.148	16-14		1.19	.21
RBB21	1,000	.148	16-14		1.19	.21
2RC10	50	.210	12-10	ERG2007	1.26	.28
RCC21	500	.210	12-10		1.26	.28
2RD8	25	.340	8	TBM6S	1.69	.36
RDD27	200	.340	8		1.69	.36
2RE6	20	.420	6		1.85	.45
REE28	200	.420	6		1.85	.45
2RF4	15	.510	4	TBM6S	1.85	.52

Tefzel®-Insulated Butt Splice

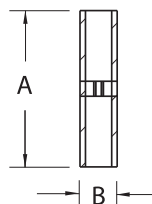

CAT. NO.	PKG. QTY.	WIRE RANGE	MAX. INS. DIA.	REC. TOOL	DIMENSIONS	
					A	B
RAAT21	1,000	22-18	1.22	WT145C	1.22	.115
RBBT21	1,000	16-14	1.22		1.22	.148
RCCT21	1,000	12-10	1.22		1.22	.210

Tefzel® is a registered trademark of DuPont.

Splice Connectors

Non-Insulated Butt Splices

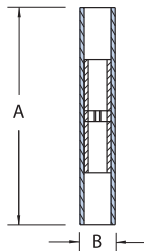

CAT. NO.	PKG. QTY.	WIRE RANGE	REC. TOOL	DIMENSIONS	
				A	B
2A-18	100	22-18	ERG2002	.62	.12
AA2	1,000	22-18		.62	.12
2B-14	100	16-14	ERG2002	.62	.16
BB2	1,000	16-14		.62	.16
2C-10	50	12-10	ERG2005	.72	.22
CC2	500	12-10		.72	.22
2D-8	25	9-8-7	ERG2005	1.03	.28
DD102	200	9-8-7		1.03	.28
2E-6	20	6-5	TBM6S	1.12	.37
EE2	200	6-5		1.12	.37
2F-4	15	4-3	TBM6S	1.25	.44
FF2	200	4-3		1.25	.44
2G21	5	2-1		1.72	.55
GG2	25	2-1		1.72	.55

Nylon-Insulated Parallel Splices

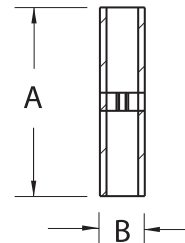

CAT. NO.	PKG. QTY.	WIRE RANGE	REC. TOOL	DIMENSIONS	
				A	B
2A20	100	22-20	ERG2001	.84	.20
RAA24	1,000	22-20		.84	.20
2B-16	100	18-16		.84	.23
RBB25	1,000	18-16		.84	.23
2C-12	50	14-12		.90	.28
RCC26	500	14-12		.90	.28

Sta-Kon® Parallel Splices

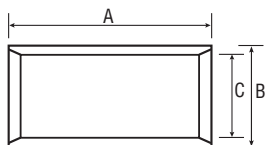

CAT. NO.	WIRE RANGE	CIR MIL RANGE	REC. TOOL	LENGTH (A)	O.D. (B)	I.D. (C)	PKG. QTY.
A18-PS-M	22-16 AWG	509-3,260	ERG2002	0.314	0.129	0.086	1,000
B14-PS-M	16-14 AWG	2,050-5,180	ERG2002	0.315	0.155	0.113	1,000
C10-PS-D	12-10 AWG	5,180-13,100	ERG2005	0.380	0.220	0.170	500
D8-PS-D	8 AWG	13,100-20,800	ERG2005	0.375	0.260	0.180	500
E6-PS-D	6 AWG	20,800-33,100	WT115A	0.500	0.365	0.266	500
F4-PS-W	4 AWG	33,100-52,600	WT115A	0.531	0.410	0.302	250
G2-PS-W	2 AWG	52,600-83,700		0.640	0.521	0.396	250
H1/0-PS-C	1/0 AWG	83,700-119,500	TBM8-750M-1	0.750	0.571	0.446	100
J2/0-PS-C	2/0 AWG	119,500-150,500		0.750	0.632	0.507	100
K3/0-PS-L	3/0 AWG	150,500-190,000		0.750	0.701	0.564	50
L4/0-PS-L	4/0 AWG	190,000-231,100		0.770	0.766	0.629	50
M250-PS-Q	250 MCM	231,100-300,000		1.063	0.926	0.749	25
N300-PS-X	300 MCM	300,000-380,000		1.125	1.100	0.882	10
P400-PS-X	400 MCM	380,000-478,000		1.250	1.200	0.956	10
R500-PS-V	500 MCM	478,000-600,000		1.438	1.330	1.060	5

The total combined cross sectional area of all wires must be within the CMA range.

Crimp-On Wire Joints, One-Piece Nylon Self-Insulated

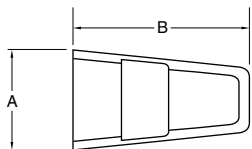

CAT. NO.	PKG. QTY.	WIRE RANGE		REC. TOOL	DIMENSIONS	
		MIN.	MAX.		A	B
RB44	100	2#18	2#16	WT2000	.31	.78
RB4-TB	1,000	2#18	2#16		.31	.78
RC55	50	4#18	2#12	WT2130A	.43	.95
RC6	500	4#18	2#12		.43	3
RP12	100	3#14	4#12		.53	1.00
RP7	1,000	3#14	4#12		.53	1.00

CAT. NO.	ALLOWABLE WIRE COMBINATIONS						
	#22	#20	#18	#16	#14	#12	#10
RB4/RB44			2-3				
			1-2	2			
	3						
		3					
	3		1				
	2	3					
	1-2		2				
	2			1			
		3	1				
	1	2					
	2		1				
	1	2					

CAT. NO.	ALLOWABLE WIRE COMBINATIONS						
	#22	#20	#18	#16	#14	#12	#10
RC6/RC55			1-4			1	
				1-3		1	
					1-2	1	
						2	
			3-5		1		
				2-4	1		
						3	
			1-4			2	
				1-3		2	
				1-3		3	
			1	3			
			2-5				
		4-6					

CAT. NO.	ALLOWABLE WIRE COMBINATIONS						
	#22	#20	#18	#16	#14	#12	#10
RP7/RP12							2
						1	1
					1		1
						2-4	
					2-4	1	
					1-3	2	
					1	3	
					3-6		
					1	2-3	
					2	1-2	
				3	1-2		
				4	1		

PT Series Crimp-On Wire Joints

Two-Piece Nylon insulator



One-Piece Non-insulated

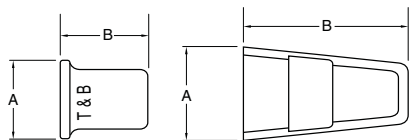

CAT. NO.	PKG. QTY.	WIRE RANGE		REC. TOOL	DIMENSIONS	
		MIN.	MAX.		A	B
PT66M	100	2#18	3#12 combination	WT161M	.50	.93
PT6M	100	—	Insulator only		.50	.93
PT60M	100	2#14	3#12 connector only		.31	.37
PT70	200	2#14	3#12		.29	.34
PT70M	200	3#18	4#12		.31	.37
PT80	50	2#16	4#10		.35	.62

Installation Procedure for "PT" Connectors



Twist wires, insert through serrated barrel of wire joint. (PT60M, PT70, PT70M, PT80).



Crimp and trim off excess wire with WT161M hand tool.



Screw PT6 insulator firmly onto PT160M barrel.

High Temperature Wire Joints

- Rated for temperatures up to 150° C (302° F), 600V maximum
- Molded, one-piece nylon construction for electrical insulation, UL94-V2
- Brazed copper sleeve prevents separation of connection during crimping
- Internal serrations enable cold flow for increased conductivity and pull-out strength



CAT. NO.	PKG. QTY.	WIRE RANGE		REC. TOOL	DIMENSIONS	
		MIN.	MAX.		A	B
RB4-HT	1,000	2#18	2#16	WT2000	.36"	.82"
RC6-HT	500	3#16	3#14	ERG2001	.48"	.95"
RP7-HT	500	3#14	3#12	WT2130A	.53"	1.00"

The heat shrinkable advantage!

- These ring terminals, butt splices and disconnects are self-insulated with heat-shrinkable polyolefin and internally coated sealant
- Self-insulated with heat-shrinkable polyolefin and internally coated sealant
- Upon completed installation, a fully sealed connection is achieved to protect the joint against the degrading effects of galvanic action, corrosion, and environmental exposure



Heat-Shrinkable Ring Terminals

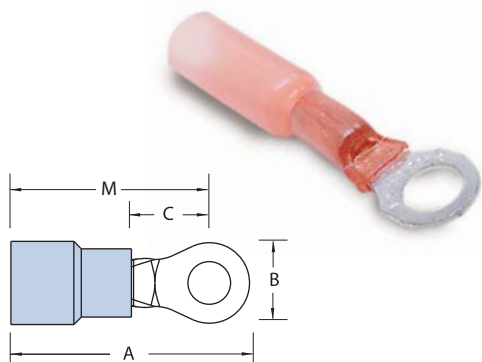

CAT. NO.	PKG. QTY.	WIRE RANGE	MAX. INS.	BOLT HOLE	REC. TOOL	DIMENSIONS				STOCK THICK.
						A	B	C	M	
RAS18-6X	100	22-18	.170	#6	ERG1255	1.23	.25	.27	1.10	.03
RAS18-8X	100	22-18	.170	#8		1.26	.31	.27	1.10	
RAS18-10X	100	22-18	.170	#10		1.26	.31	.27	1.10	
RBS14-6X	100	16-14	.200	#6		1.23	.25	.27	1.10	.04
RBS14-8X	100	16-14	.200	#8		1.23	.25	.27	1.10	
RBS14-10X	100	16-14	.200	#10		1.26	.31	.27	1.10	
RCS10-6X	50	12-10	.250	#6		1.34	.31	.27	1.15	.04
RCS10-8X	50	12-10	.250	#8		1.34	.37	.27	1.15	
RCS10-10X	50	12-10	.250	#10		1.34	.37	.27	1.15	
RCS10-14X	50	12-10	.250	1/4"		1.34	.49	.32	1.15	

Heat-Shrinkable Locking Fork Terminals

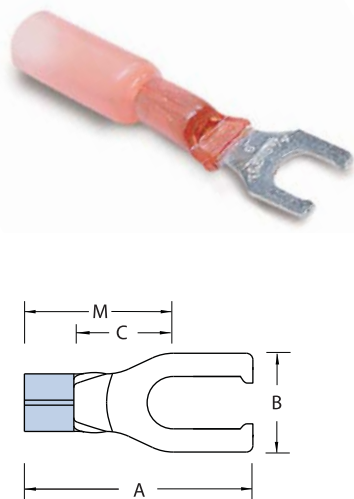

CAT. NO.	PKG. QTY.	WIRE RANGE	MAX. INS.	BOLT HOLE	REC. TOOL	DIMENSIONS				STOCK THICK.
						A	B	C	M	
RAS18-6FLX	100	22-18	.170	#6	ERG1255	1.350	.25	—	—	.03
RAS18-8FLX	100	22-18	.170	#8		1.350	.29	—	—	
RAS18-10FLX	100	22-18	.170	#10		1.350	.29	—	—	
RBS14-6FLX	100	16-14	.200	#6		1.350	.25	—	—	.04
RBS14-8FLX	100	16-14	.200	#8		1.350	.29	—	—	
RBS14-10FLX	100	16-14	.200	#10		1.350	.29	—	—	
RCS10-6FLX	50	12-10	.250	#6		1.350	.31	—	—	.04
RCS10-8FLX	50	12-10	.250	#8		1.350	.37	—	—	
RCS10-10FLX	50	12-10	.250	#10		1.350	.37	—	—	
RCS10-14FLX	50	12-10	.250	1/4"		1.350	.49	—	—	

Heat-Shrinkable Terminals, Splices and Disconnects

Heat-Shrinkable Fully Insulated Female Disconnects



CAT. NO.	PKG. QTY.	WIRE RANGE	MAX. INS.	TAB SIZE	REC. TOOL	A
RAS18-250AX	25	22-18	.170	.250 x .032	ERG1255	1.82
RBS14-250AX	25	16-14	.200	.250 x .032		1.77
RCS10-250AX	25	12-10	.250	.250 x .032		1.80

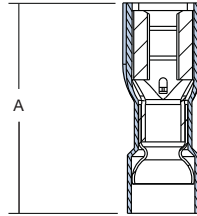

Heat-Shrinkable Fully Insulated Male Tabs



CAT. NO.	PKG. QTY.	WIRE RANGE	MAX. INS.	TAB SIZE	REC. TOOL	A
18RAS-251TX	25	22-18	.170	.250 x .032	ERG1255	1.80
14RBS-251TX	25	16-14	.200	.250 x .032		1.75
10RCS-251TX	25	12-10	.250	.250 x .032		1.80

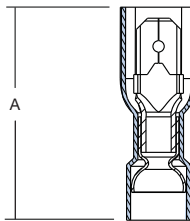

Heat-Shrinkable Butt Splices



CAT. NO.	PKG. QTY.	WIRE RANGE	MAX. INS.	REC. TOOL	DIMENSIONS	
					A	B
2RAS18X	50	22-18	.170	ERG1255	1.50	.25
RAAS22X	500	22-18	.170		1.50	.25
2RBS14X	50	16-14	.200		1.50	.26
RBBS22X	500	16-14	.200		1.50	.26
2RCS10X	25	12-10	.250		1.60	.31
RCCS22X	250	12-10	.250		1.60	.31

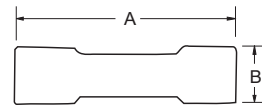

Everything you need to make fully sealed connections in one handy kit.

Heat-Shrink Terminal Kit with Tools

- Tools: (1) butane torch; (1) wire stripper; (1) ratchet crimp tool
- Butt Splices: (20) 22-18 AWG; (20) 16-14 AWG; (15) 12-10 AWG
- Ring Terminals: (20) 16-14 AWG #10 stud; (2) 16-14 AWG #8 stud; (15) 12-10 AWG ¼" stud



CAT. NO.	DESCRIPTION	STD. PKG. QTY.
STAPOUCH-HS	Heat-Shrink Terminal Kit with Tools	1

Disconnects

- Internal barrel serrations and long barrel provide for maximum tensile strength
 - Complete line of installing tools, engineered to match tool with terminal
 - Funnel entry insulators enable easier inserting of wire into barrel
 - Color-coded for easy installation
- 250 Series — Female Disconnects**
- Supplied in a variety of styles to meet virtually all quick-disconnect requirements
 - Female disconnect terminals and matching male tabs accommodate a range of 22–10 AWG, and are available in non-insulated, partially insulated, and fully insulated styles, in both nylon and vinyl
 - Available in various tab widths including .250", .187" and .110" and a combination size
 - Unique construction of the female disconnect offers long-term dependability
 - Brazed seam serrated barrel provides maximum tensile strength

187 Series — Female Disconnects

- Quick, reliable method of connection to terminal blocks and boards without the use of tools
- Supplied in a variety of styles to meet virtually all quick-disconnect requirements
- Female disconnect terminals and matching male tabs accommodate a range of 22–10 AWG, and are available in non-insulated, partially insulated, and fully insulated styles, in both nylon and vinyl
- Available in various tab widths including .250", .187", and .110", and a combination size
- Unique construction of the female disconnect offers long-term dependability



250 Series — Female Disconnects

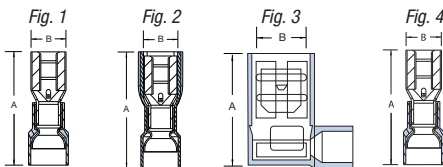

CAT. NO.	PKG. QTY.	WIRE RANGE	MAX. INS.	TAB SIZE	FIG.	REC. TOOL	DIMENSIONS	
							A	B
RA18-250F	100	22-18	.136	.250 x .032	1	ERG2001	.91	.29
RA250	1,000	22-18	.136	.250 x .032	1		.91	.29
RB14-250F	100	16-14	.162	.250 x .032	1		.91	.29
RB250	1,000	16-14	.162	.250 x .032	1		.91	.29
RC10-250F	50	12-10	.215	.250 x .032	1		1.04	.29
RC250	500	12-10	.215	.250 x .032	1		1.04	.29
18RA-250F	100	22-18	.150	.250 x .032	1		.96	.29
RA257	1,000	22-18	.150	.250 x .032	1		.96	.29
RA257-170	1,000	22-18	.170	.250 x .032	1		.96	.29
14RB-250F	100	16-14	.170	.250 x .032	1		.96	.29
RB257	1,000	16-14	.170	.250 x .032	1		.96	.29
RB257-200	1,000	16-14	.200	.250 x .032	1		.96	.29
10RC-250F	50	12-10	.250	.250 x .032	1		1.03	.29
RC257	500	12-10	.250	.250 x .032	1		1.03	.29
18RA-2577	100	22-18	.165	.250 x .032	2		1.01	.38
RA2573	1,000	22-18	.165	.250 x .032	2		1.01	.38
14RB-2577	100	16-14	.185	.250 x .032	2		1.01	.38
RB2573	1,000	16-14	.185	.250 x .032	2		1.01	.38
10RC-2577	50	12-10	.225	.250 x .032	2		1.04	.38
RC2573	500	12-10	.225	.250 x .032	2		1.04	.38
RA18-250A	50	22-18	.170	.250 x .032	3		.80	.71
RA2577F	500	22-18	.170	.250 x .032	3		.80	.71
RB14-250A	50	16-14	.190	.250 x .032	3		.80	.72
RB2577F	500	16-14	.190	.250 x .032	3		.80	.72
RC10-250A	50	12-10	.245	.250 x .032	3	.80	.88	
RC2577F	500	12-10	.245	.250 x .032	3	.80	.88	
A18-250	100	22-18	—	.250 x .032	1	ERG2002	.73	.31
A250	1,000	22-18	—	.250 x .032	1		.73	.31
B14-250	100	16-14	—	.250 x .032	1		.73	.31
B250	1,000	16-14	—	.250 x .032	1		.73	.31
C10-250F	50	12-10	—	.250 x .032	1		.73	.31
C250	500	12-10	—	.250 x .032	1		.73	.31
B14-250F	100	16-14	—	.250 x .032	4	WT110M	.87	.31
B250G	1,000	16-14	—	.250 x .032	4		.87	.31

(Continued on facing page)

250 Series — Female Disconnects (continued)

7 Non-insulated
90° flag



CAT. NO.	PKG. QTY.	WIRE RANGE	MAX. INS.	TAB SIZE	FIG.	REC. TOOL	DIMENSIONS	
							A	B
A18-250A	50	22-18	—	.250 x .032	3	ERG2002	.58	.61
A252G	500	22-18	—	.250 x .032	3		.58	.61
B14-250A	50	16-14	—	.250 x .032	3	ERG2002	.58	.62
B252G	500	16-14	—	.250 x .032	3		.58	.62
C10-250A	50	12-10	—	.250 x .032	3	ERG2005	.64	.63
C252G	500	12-10	—	.250 x .032	3		.64	.63

250 Series — Piggy Back Disconnects

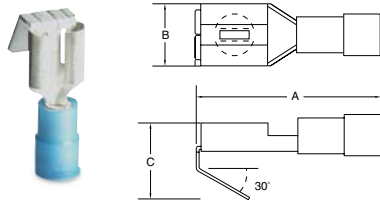

CAT. NO.	PKG. QTY.	WIRE RANGE	MAX. INS.	TAB SIZE	REC. TOOL	DIMENSIONS		
						A	B	C
RA18-250FP	100	22-18	.136	.250 x .032	WT112M ERG2001	.87	.30	.43
RA250P	1,000	22-18	.136	.250 x .032		.87	.30	.43
RB14-250FP	100	16-14	.163	.250 x .032	ERG2001	.87	.30	.43
RB250P	1,000	16-14	.163	.250 x .032		.87	.30	.43

187 Series — Female Disconnects

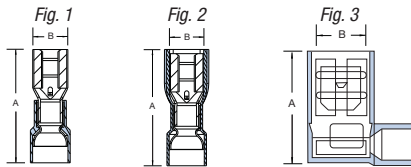

1 Nylon self-insulated



2 Vinyl self-insulated



3 Nylon fully insulated



4 Non-insulated



5 Nylon fully insulated 90° flag



CAT. NO.	PKG. QTY.	WIRE RANGE	MAX. INS.	TAB SIZE	FIG.	REC. TOOL	DIMENSIONS		
							A	B	
RAD18-183	100	22-18	.136	.187 x .032	1	ERG2001	.83	.23	
RAD1833	1,000	22-18	.136	.187 x .032	1		.83	.23	
RAD18-182	100	22-18	.136	.187 x .020	1		.83	.23	
RAD1823	1,000	22-18	.136	.187 x .020	1		.83	.23	
RBD14-183	100	16-14	.163	.187 x .032	1		.83	.23	
RBD1833	1,000	16-14	.163	.187 x .032	1		.83	.23	
RBD14-182	100	16-14	.163	.187 x .020	1		.83	.23	
RBD1823	1,000	16-14	.163	.187 x .020	1		.83	.23	
18RAD-183	100	22-18	.150	.187 x .032	1		ERG2001	.85	.23
RAD1837	1,000	22-18	.150	.187 x .032	1			.85	.23
18RAD-182	100	22-18	.150	.187 x .020	1			.85	.23
RAD1827	1,000	22-18	.150	.187 x .020	1			.85	.23
14RBD-183	100	16-14	.170	.187 x .032	1	.85		.23	
RBD1837	1,000	16-14	.170	.187 x .032	1	.85		.23	
14RBD-182	100	16-14	.170	.187 x .020	1	.85		.23	
RBD1827	1,000	16-14	.170	.187 x .020	1	.85		.23	
18RAD-18377	100	22-18	.150	.187 x .032	2	ERG2001		.89	.30
RAD18377	1,000	22-18	.150	.187 x .032	2			.89	.30
18RAD-18277	100	22-18	.150	.187 x .020	2			.89	.30
RAD18277	1,000	22-18	.150	.187 x .020	2			.89	.30
14RBD-18377	100	16-14	.170	.187 x .032	2		.89	.30	
RBD18377	1,000	16-14	.170	.187 x .032	2		.89	.30	
14RBD-18277	100	16-14	.170	.187 x .020	2		.89	.30	
RBD18277	1,000	16-14	.170	.187 x .020	2		.89	.30	
AD18-183	100	22-18	—	.187 x .032	1		ERG2002	.64	.23
AD183	1,000	22-18	—	.187 x .032	1			.64	.23
AD18-182	100	22-18	—	.187 x .020	1			.64	.23
AD182	1,000	22-18	—	.187 x .020	1			.64	.23
BD14-183	100	16-14	—	.187 x .032	1	.64		.23	
BD183	1,000	16-14	—	.187 x .032	1	.64		.23	
BD14-182	100	16-14	—	.187 x .020	1	.64		.23	
RAD18-187A	50	22-18	.150	.187 x .032	3	ERG2001		.74	.59
RAD1877F	500	22-18	.150	.187 x .032	3			.74	.59
RAD18-188A	50	22-18	.150	.187 x .020	3			.74	.59
RAD1887F	500	22-18	.150	.187 x .020	3			.74	.59
RBD14-187A	50	16-14	.170	.187 x .032	3			.74	.61
RBD1877F	500	16-14	.170	.187 x .032	3		.74	.61	
RBD14-188A	50	16-14	.170	.187 x .020	3		.74	.61	
RBD1887F	500	16-14	.170	.187 x .020	3		.74	.61	

U.L. Listed E66716

Select the tabs you need! 250 Series — Male Tabs

1 Vinyl self-insulated



2 Nylon fully insulated



3 Non-insulated/insulated Grip



4 Non-insulated

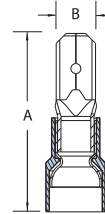

CAT. NO.	PKG. QTY.	WIRE RANGE	MAX. INS.	TAB SIZE	REC. TOOL	DIMENSIONS	
						A	B
18RA-250T	100	22-18	.150	.250 x .032	ERG2001	.95	—
RA2517	1,000	22-18	.150	.250 x .032		.95	—
14RB-250T	100	16-14	.170	.250 x .032		.95	—
RB2517	1,000	16-14	.170	.250 x .032		.95	—
10RC-250T	50	12-10	.250	.250 x .032		1.08	—
RC2517	500	12-10	.250	.250 x .032		1.08	—
18RA-251T	50	22-18	.150	.250 x .032		1.13	.45
RA25177	500	22-18	.150	.250 x .032		1.13	.45
14RB-251T	50	16-14	.170	.250 x .032		1.13	.45
RB25177	500	16-14	.170	.250 x .032		1.13	.45
10RC-251T	25	12-10	.210	.250 x .032		1.17	.45
RC25177	500	12-10	.210	.250 x .032		1.17	.45
A18-250T	100	22-18	—	.250 x .032	WT110M	.87	—
B14-250T	100	20-14	—	.250 x .032	WT110M	.87	—
A18-251T	100	22-18	—	.250 x .032	ERG2002	.68	—
A251	1,000	22-18	—	.250 x .032		.68	—
B14-251T	100	16-14	—	.250 x .032		.68	—
B251	1,000	16-14	—	.250 x .032		.68	—
C10-251T	50	12-10	—	.250 x .032		.68	—

187 Series — Male Tabs

5 Vinyl insulated

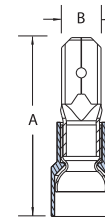

CAT. NO.	PKG. QTY.	TAB SIZE	WIRE RANGE	MAX. INS.	REC. TOOL	DIA.	
						A	B
18RAD-187	100	.187 x .032	22-18	.150	ERG2001	.87	—
18RAD-188	100	.187 x .020	22-18	.150		.87	—
14RBD-187	100	.187 x .032	16-14	.170		.87	—
14RBD-188	100	.187 x .020	16-14	.170		.87	—

Insulated coupler requires no tool!

250 Series — Adapters and Coupler†

6 Non-insulated



7 Insulated coupler

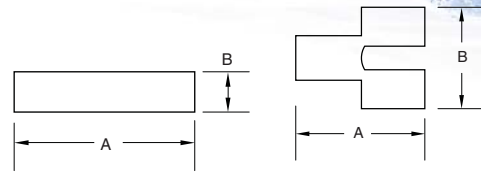

CAT. NO.	PKG. QTY.	TAB SIZE	DIMENSIONS	
			A	B
6 F250TA	50	.250 x .032	.82	.56
6 FTA250	1,000	.250 x .032	.82	.56
7 RB14-250	50	.250 x .032	2.35	.51
7 RBB250	500	.250 x .032	2.35	.51

† Not UL Listed

Cat. No. F250TA — **Material:** brass **Finish:** tin plated

Cat. No. RB14-250 — **Material:** brass **Finish:** none **Insulation:** vinyl

Available in variety of wire ranges!

110 Series — Disconnects*

8 Nylon-insulated



9 Non-insulated



CAT. NO.	PKG. QTY.	TAB SIZE	WIRE RANGE	MAX. INS.	REC. TOOL	DIMENSIONS	
						A	B
RA18-110F	100	.110 x .032	22-18	.110	ERG2006	.75	.15
RA10-SK	1,000	.110 x .032	22-18	.110		.75	.15
RA18-111F	100	.110 x .020	22-18	.110		.75	.15
RA11	1,000	.110 x .020	22-18	.110		.75	.15
RB14-110F	100	.110 x .032	16-14	.135		.75	.15
RB10-SK	1,000	.110 x .032	16-14	.135	.75	.15	
RB14-111F	100	.110 x .020	16-14	.135	.75	.15	
RB11-TB	1,000	.110 x .020	16-14	.135	.75	.15	
A18-110F	100	.110 x .032	22-18	—	WT111M ERG2002	.59	.15
A10-TB	1,000	.110 x .032	22-18	—		.59	.15
A18-111F	100	.110 x .020	22-18	—		.59	.15
A11	1,000	.110 x .020	22-18	—		.59	.15
B14-110F	100	.110 x .032	16-14	—		.59	.15
B10-TB	1,000	.110 x .032	16-14	—		.59	.15
B14-111F	100	.110 x .020	16-14	—		.59	.15
B11-TB	1,000	.110 x .020	16-14	—		.59	.15

*Not UL Listed or CSA approved.

Choose from nylon-insulated or non-insulated!

10 Nylon-Insulated Wristlock Disconnects



11 Non-Insulated Wristlock Disconnects



Picture shows wristlock disconnect assembled as two pieces. Parts are sold by the piece not by assemblies.

Wristlock Disconnects†

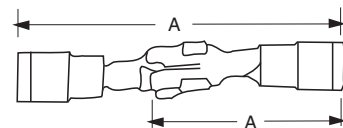

CAT. NO.	PKG. QTY.	WIRE RANGE	MAX. INS.	REC. TOOL	DIMENSIONS	
					A	A1
RA18D	50	22-18	.136	WT2000	.99	1.70
RA23	1,000	22-18	.136		.99	1.70
RB14D	50	16-14	.162		.99	1.70
RB23	1,000	16-14	.162	.99	1.70	
B14-D	50	16-14	.187	WT110M	.97	1.66
B23	1,000	16-14	.187		.97	1.66

† Not UL Listed

United States
Tel: 901.252.8000
800.816.7809
Fax: 901.252.1354

Technical Services
Tel: 888.862.3289

Thomas & Betts

www.tnb.com

Sta-Kon®

Disconnects & Male Tabs

Continuously molded for high-productivity, jam-free automation!

Plastic Strip Terminals

NEW!

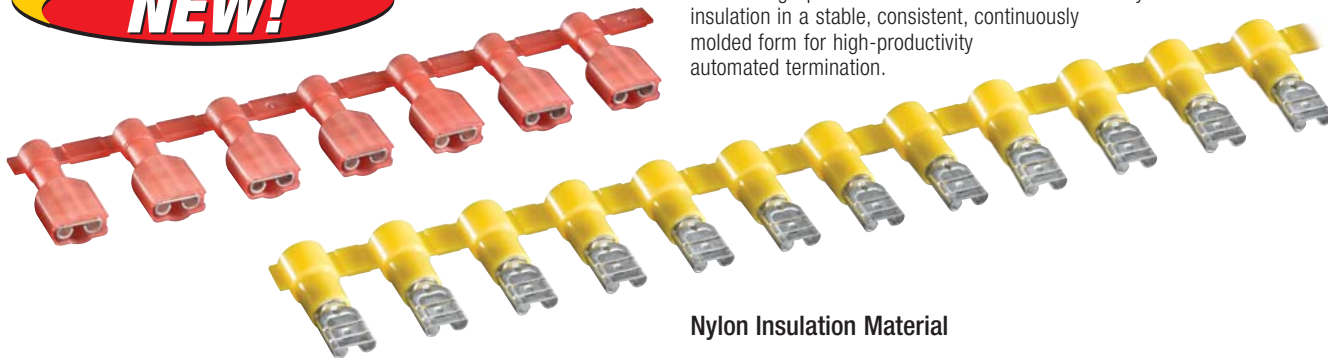

Thomas & Betts has been an innovator in terminal design since it invented the first tool-applied, solderless terminals and connectors in the early 1930s. Continuing that tradition of innovation today, this latest addition to the Sta-Kon® family of terminal products offers OEMs a high-performance line of disconnects with nylon insulation in a stable, consistent, continuously molded form for high-productivity automated termination.

Nylon Insulation Material

- UL94V-2 flammability rating
- Withstands operating temperatures to 105° C
- Chemical, impact and abrasion resistant

Continuously Molded for Stable, High-Volume Production

- Reduces costly downtime — won't jam equipment and tooling like Mylar-tape systems
- More consistent in form than welded-together plastic strips

The Quality of the Original Sta-Kon® Quick Disconnect

- Funnel-entry insulator eliminates hang-ups for faster, easier wire insertion
- Internal barrel serrations increase conductivity and pull-out strength
- Sleeved barrel prevents the separation that can diminish both pull-out strength and dielectric performance
- 600V maximum
- cULus Listed



CAT. NO.	WIRE RANGE (AWG)	TAB SIZE (IN.)	PKG. QTY.
Male Quick Disconnects			
RA250T-PS	22-16	.250 x .032	2,500
RB250T-PS	16-14	.250 x .032	2,500
RC250T-PS	12-10	.250 x .032	2,000
Female Quick Disconnects			
RA111D-PS	22-16	.110 x .020	2,500
RA110D-PS	22-16	.110 x .032	2,500
RA188D-PS	22-16	.187 x .020	2,500
RA187D-PS	22-16	.187 x .032	2,500
RA250D-PS	22-16	.250 x .032	2,500
RB188D-PS	16-14	.187 x .020	2,500
RB111D-PS	16-14	.110 x .020	2,500
RB110D-PS	16-14	.110 x .032	2,500
RB187D-PS	16-14	.187 x .032	2,500
RB250D-PS	16-14	.250 x .032	2,500
RC250D-PS	12-10	.250 x .032	2,000
Female Quick Disconnects — Fully Insulated			
RA250DF-PS	22-16	.250 x .032	2,500
RB250DF-PS	16-14	.250 x .032	2,500
RC250DF-PS	12-10	.250 x .032	2,000



For tooling, refer to page F-38.

Sta-Kon® Terminal Products and Tools

Thomas & Betts

www.tnb.com

United States
Tel: 901.252.8000
800.816.7809
Fax: 901.252.1354

Technical Services
Tel: 888.862.3289

Meets 2008 UL requirements for fluorescent fixtures and ballasts!

Luminaire Disconnects

- Oversized electrical contacts improve conductivity and reduce temperature rise
- Integral wire leads ease installation — even with multiple wire sizes — and support connection to copper or aluminum wiring
- Foolproof design ensures mating halves of disconnect are installed correctly, preventing reverse polarization
- Finger-safe line side protects installer and enables safe servicing without disconnecting power
- Line and load indications clearly identified on each half
- Rounded, compact design fits in tight spaces
- Bright orange for instant identification as a safety device

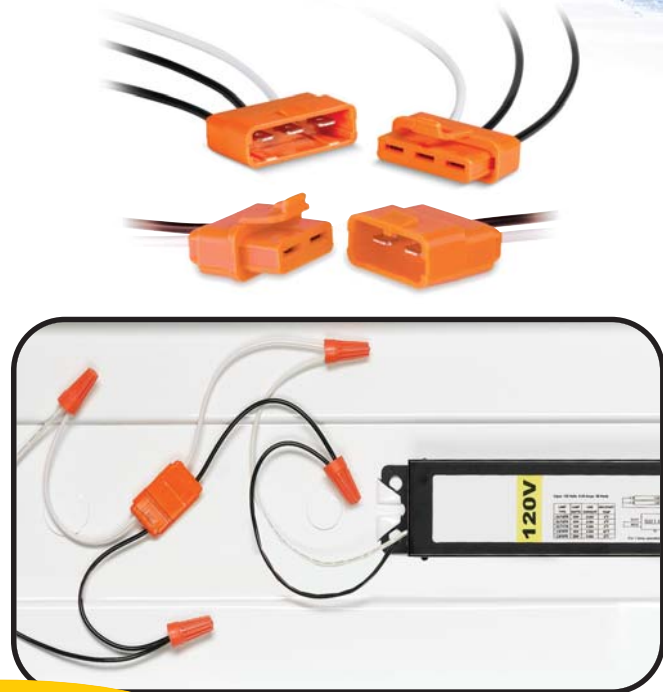

NEW!



Specifications

- Housing: Polycarbonate
- Contacts: Tin-plated brass
- Integral Leads: Insulated 18 AWG solid copper
- Temp. Rating: 105° C
- Flammability: UL94V-2 (V-0 available on request)
- Electrical Rating: 4A, 600V
- Standards: UL Listed, CSA Certified, NEC® Section 410.130(G) 2008 edition compliant

CAT. NO.	DESCRIPTION	PKG. QTY.
<i>Bulk Packaging for OEMs</i>		
LD2-D	2-Pole Luminaire Disconnect	500
LD3-D	3-Pole Luminaire Disconnect	500
<i>Kits for Servicing Electricians (includes two male/line half and two female/load half of the luminaire disconnect polybagged with installation instructions)</i>		
LD2	2-Pole Luminaire Disconnect Kit	20
LD3	3-Pole Luminaire Disconnect Kit	20

Faster, easier and safer than manual seating of disconnects!

Disconnect Installation Tool

- Perfect for wire-harness assemblers and panel builders
- Dual-ended with slots to fit red and blue (male and female) or yellow disconnects
- Color-coded dots for easy matching of disconnect with correct tool end
- Lightweight and only 5½" long — fits in a shirt pocket like a pen



This one-of-a-kind, patent-pending tool may be used to seat all sizes of Thomas & Betts disconnects.

CAT. NO.	DESCRIPTION	PKG. QTY.
DT22-10	Sta-Kon® Disconnect Installation Tool	1

Insulated Ferrules

Features

- Ferrules ensure reliable electrical connections when terminating conductors in screw clamp terminal blocks
- Fraying and breaking of wire strands is prevented and the possibility of an unreliable connection is minimized
- Insulated ferrules prevent conductor breakage due to bending, wire stress, or vibration, while facilitating wire insertions into the terminal block clamp
- Ferrules are the preferred alternative to twisting wire stands or tinning the wire end before terminating into a terminal block
- Ferrules are thin-walled copper tubes, which are mechanically crimped onto the ends of stranded wires
- They are easy to use — simply strip the wire, slide the ferrule onto the end of the wire and crimp
- Meets emerging global standards, requiring wire-to-metric style terminal block installations be terminated with a “pin” style terminal
- Available in vinyl insulated, nylon insulated, and non-insulated styles
- All styles offered in 22 AWG to 10 AWG and compatible with existing Sta-Kon® tooling

How to Apply a Ferrule

- Strip the insulation from the end of the wire and insert into the insulated end of the ferrule
- Using the designated crimping tool, place the metal shaft into the tool's appropriate slot. Compress the tool to make a crescent-shape depression along the length of the ferrule
- Insert the crimped ferrule into the terminal block
- Tighten the ferrule and wire into the terminal block

Materials

- High conductivity copper
- Tin plating

Insulated Ferrules

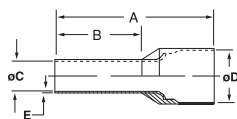

CAT. NO.	CONDUCTOR SECTION		COLOR	DIMENSIONS INCHES/MM					INSTALLATION TOOLING	PKG. QTY.
	AWG	MM2		A	B	ØC	ØD	E		
F4004	26	0.14	Gray	.413/10.5	.236/6.0	.031/.80	.079/2.0	.010/.25	T3, ERG2	500
F4005	26	0.14	Gray	.492/12.5	.315/8.0	.031/.80	.079/2.0	.010/.25	T3, ERG2	500
F4006	24	0.25	Yellow	.413/10.5	.236/6.0	.031/.80	.079/2.0	.010/.25	T3, ERG2	500
F4007	24	0.25	Yellow	.492/12.5	.315/8.0	.031/.80	.079/2.0	.010/.25	T3, ERG2	500
F4008	22	0.34	Purple	.413/10.5	.236/6.0	.031/.80	.079/2.0	.010/.25	T3, ERG2	500
F4009	22	0.34	Purple	.492/12.5	.315/8.0	.031/.80	.079/2.0	.010/.25	T3, ERG2	500
F2020	20	0.50	White	.453/11.5	.236/6.0	.043/1.1	.098/2.5	.006/0.15	T1, T3 & ERG2	500
F2021	20	0.50	White	.531/13.5	.315/8.0	.043/1.1	.098/2.5	.006/0.15	T1, T3 & ERG2	500
F2022	20	0.50	White	.610/15.5	.394/10.0	.043/1.1	.098/2.5	.006/0.15	T1, T3 & ERG2	500
F2023	18	0.75	Gray	.472/12.0	.236/6.0	.051/1.3	.110/2.8	.006/0.15	T1, T3 & ERG2	500
F2024	18	0.75	Gray	.551/14.0	.315/8.0	.051/1.3	.110/2.8	.006/0.15	T1, T3 & ERG2	500
F2025	18	0.75	Gray	.630/16.0	.394/10.0	.051/1.3	.110/2.8	.006/0.15	T1, T3 & ERG2	500
F2026	18	0.75	Gray	.709/18.0	.472/12.0	.051/1.3	.110/2.8	.006/0.15	T1, T3 & ERG2	500
F2027	18	1.00	Red	.492/12.5	.236/6.0	.059/1.5	.118/3.0	.006/0.15	T1, T3 & ERG2	500
F2028	18	1.00	Red	.571/14.5	.315/8.0	.059/1.5	.118/3.0	.006/0.15	T1, T3 & ERG2	500
F2029	18	1.00	Red	.650/16.5	.394/10.0	.059/1.5	.118/3.0	.006/0.15	T1, T3 & ERG2	500
F2030	18	1.00	Red	.728/18.5	.472/12.0	.059/1.5	.118/3.0	.006/0.15	T1, T3 & ERG2	500
F2031	16	1.50	Black	.571/14.5	.315/8.0	.071/1.8	.134/3.4	.006/0.15	T1, T3 & ERG2	500
F2032	16	1.50	Black	.650/16.5	.394/10.0	.071/1.8	.134/3.4	.006/0.15	T1, T3 & ERG2	500
F2033	16	1.50	Black	.728/18.5	.472/12.0	.071/1.8	.134/3.4	.006/0.15	T1, T3 & ERG2	500
F2034	16	1.50	Black	.965/24.5	.708/18.0	.071/1.8	.134/3.4	.006/0.15	T1, T3 & ERG2	500
F2035	14	2.50	Blue	.591/15.0	.315/8.0	.091/2.3	.165/4.2	.006/0.15	T1, T3 & ERG2	500
F2036	14	2.50	Blue	.748/19.0	.472/12.0	.091/2.3	.165/4.2	.006/0.15	T1, T3 & ERG2	500
F2037	14	2.50	Blue	.984/25.0	.708/18.0	.091/2.3	.165/4.2	.006/0.15	T1, T3 & ERG2	500
F2038	12	4.00	Gray	.889/17.5	.394/10.0	.114/2.9	.189/4.8	.008/0.20	T3 & ERG2	500
F2039	12	4.00	Gray	.787/20.0	.472/12.0	.114/2.9	.189/4.8	.008/0.20	T3 & ERG2	500
F2040	12	4.00	Gray	1.024/26.0	.708/18.0	.114/2.9	.189/4.8	.008/0.20	T3 & ERG2	100
F2041	10	6.00	Yellow	.787/20.0	.472/12.0	.142/3.6	.244/6.2	.008/0.20	T3 & ERG2	100
F2042	10	6.00	Yellow	.984/25.0	.708/18.0	.142/3.6	.244/6.2	.008/0.20	T3 & ERG2	100
F2043	8	10.00	Red	.827/21.0	.472/12.0	.181/4.6	.295/7.5	.008/0.20	T3 & ERG2	100
F2044	8	10.00	Red	1.063/27.0	.708/18.0	.181/4.6	.295/7.5	.008/0.20	T3 & ERG2	100
F2045	6	16.00	Blue	.906/23.0	.472/12.0	.236/6.0	.346/8.8	.008/0.20	ERG2	100
F2046	6	16.00	Blue	1.142/29.0	.708/18.0	.236/6.0	.346/8.8	.008/0.20	ERG2	50
F2047	4	25.00	Yellow	1.142/29.0	.630/18.0	.295/7.5	.433/11.0	.008/0.20	ERG2	50
F2048	4	25.00	Yellow	1.220/31.0	.708/18.0	.295/7.5	.433/11.0	.008/0.20	ERG2	50
F2049	4	25.00	Yellow	1.378/35.0	.866/22.0	.295/7.5	.433/11.0	.008/0.20	ERG2	50
F2050	2	35.00	Red	1.181/30.0	.630/16.0	.335/8.5	.492/12.5	.008/0.20	ERG2	50
F2051	2	35.00	Red	1.260/32.0	.708/18.0	.335/8.5	.492/12.5	.008/0.20	ERG2	50
F2052	2	35.00	Red	1.535/39.0	.984/25.0	.335/8.5	.492/12.5	.008/0.20	ERG2	50
F2053	1/0	50.00	Blue	1.417/36.0	.787/20.0	.413/10.5	.591/15.0	.014/0.35	ERG2	50
F2054	1/0	50.00	Blue	1.614/41.0	.984/25.0	.413/10.5	.591/15.0	.014/0.35	ERG2	50

Ferrule Dimensions conform to DIN 46228. Part 4.

Insulated Twin Ferrules

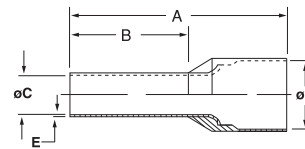

CAT. NO.	CONDUCTOR SECTION		COLOR	DIMENSIONS INCHES/MM					INSTALLATION TOOLING	PKG. QTY.
	AWG	MM		A	B	ØC	ØD	E		
F8000	2x 20	2x 0.50	White	.591/15.0	.315/8.0	.059/1.5	.177/4.5	.010/0.25	T3	500
F8001	2x 18	2x 0.75	Gray	.591/15.0	.315/8.0	.071/1.8	.201/5.1	.010/0.25	T3	500
F8002	2x 18	2x 0.75	Gray	.669/17.0	.394/10.0	.071/1.8	.201/5.1	.006/0.15	T3	500
F8003	2x 17	2x 1.00	Red	.591/15.0	.315/8.0	.081/2.05	.201/5.1	.006/0.15	T3	500
F8005	2x 17	2x 1.00	Red	.669/17.0	.394/10.0	.081/2.05	.201/5.1	.006/0.15	T3	500
F8006	2x 16	2x 1.50	Black	.630/16.0	.315/8.0	.091/2.3	.252/6.4	.006/0.15	T3	500
F8007	2x 16	2x 1.50	Black	.787/20.0	.472/12.0	.091/2.3	.252/6.4	.006/0.15	T3	500
F8008	2x 14	2x 2.50	Blue	.728/18.5	.394/10.0	.114/2.9	.295/7.5	.006/0.15	T3	500
F8009	2x 14	2x 2.50	Blue	.846/21.5	.512/13.0	.114/2.9	.295/7.5	.006/0.15	T3	500
F8010	2x 12	2x 4.00	Gray	.906/23.0	.472/12.0	.150/3.8	.339/8.6	.006/0.15	ERG2/6MM DIE	100
F8011	2x 10	2x 6.00	Yellow	.984/25.0	.551/14.0	.193/4.9	.378/9.6	.008/0.20	ERG2/10MM DIE	100

Ferrule Dimensions conform to DIN 46228, Part 4.

Insulated Ferrules (Old DIN and French Standards)

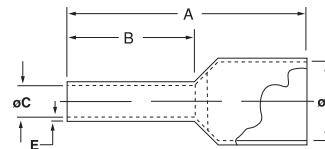
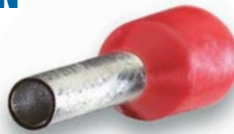

CAT. NO.	STYLE	CONDUCTOR SECTION			DIMENSIONS INCHES/MM					INSTALLATION TOOLING	PKG. QTY.
		AWG	MM	COLOR	A	B	ØC	ØD	E		
F4000	OLD DIN	20	0.50	Orange	.571/14.5	.315/8.0	.043/1.1	.102/2.6	.006/0.15	T1, T3 & ERG2	500
F4001	OLD DIN	18	0.75	White	.571/14.5	.315/8.0	.051/1.3	.110/2.8	.006/0.15	T1, T3 & ERG2	500
F4002	OLD DIN	18-17	1.00	Yellow	.571/14.5	.315/8.0	.059/1.5	.118/3.0	.006/0.15	T1, T3 & ERG2	500
F4003	OLD DIN	16	1.50	Red	.571/14.5	.315/8.0	.071/1.8	.134/3.4	.006/0.15	T1, T3 & ERG2	500
F4020	OLD DIN	14	2.50	Blue	.571/14.5	.315/8.0	.091/2.3	.165/4.2	.006/0.15	T1, T3 & ERG2	500
F4021	FRENCH	20	0.50	White	.571/14.5	.315/8.0	.043/1.1	.102/2.6	.006/0.15	T1, T3 & ERG2	500
F4023	FRENCH	18	0.75	Lt. Blue	.571/14.5	.315/8.0	.051/1.3	.110/2.8	.006/0.15	T1, T3 & ERG2	500
F4024	FRENCH	18-17	1.00	Red	.571/14.5	.315/8.0	.059/1.5	.118/3.0	.006/0.15	T1, T3 & ERG2	500
F4027	FRENCH	16	1.50	Black	.571/14.5	.315/8.0	.071/1.8	.134/3.4	.006/0.15	T1, T3 & ERG2	500
F4028	FRENCH	14	2.50	Gray	.571/14.5	.315/8.0	.091/2.3	.165/4.2	.006/0.15	T1, T3 & ERG2	500

Ferrule Dimensions conform to DIN 46228, Part 4.

The crimping tools you need! Tooling for Sta-Kon® Insulated Ferrules

CAT. NO.	DESCRIPTION	PKG. QTY.
T1	Sta-Kon® Crimp Tool for Wire Ferrules #20-14 AWG — Insulated Handle	1
T3	Sta-Kon® Crimp Tool for Wire Ferrules #26-10 AWG — Insulated Handle	1
ERG2	Comfort Crimp® Sta-Kon® Crimp Tool with Shure-Stake® mechanism, for installing wire ferrules #26-1/0 AWG. 4 interchangeable die sets included. Insulated handle. Packaged in sturdy plastic carrying case.	1



Sta-Kon®

Non-Insulated Ferrules

Non-Insulated Ferrule

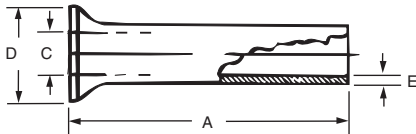

Sta-Kon® Terminal Products and Tools

CAT. NO.	CONDUCTOR SECTION		DIMENSIONS (INCHES/MM)				INSTALLATION TOOLING	PKG. QTY.
	AWG	MM	A	C	D	E		
F9000	24	0.25	.196/5	.030/0.75	.067/1.7	.006/0.15	T1, ERG2 T3	1,000
F9001	22	0.5	.236/6	.039/1.0	.083/2.1	.006/0.15	T1, T3, ERG2	1,000
F9002	22	0.5	.394/10	.039/1.0	.083/2.1	.006/0.15	T1, T3, ERG2	1,000
F9003	18	0.75	.236/6	.047/1.2	.091/2.3	.006/0.15	T1, T3, ERG2	1,000
F9004	18	0.75	.394/10	.047/1.2	.091/2.3	.006/0.15	T1, T3, ERG2	1,000
F9005	18	1	.236/6	.055/1.4	.098/2.5	.006/0.15	T1, T3, ERG2	1,000
F9006	18	1	.394/10	.055/1.4	.098/2.5	.006/0.15	T1, T3, ERG2	1,000
F9007	16	1.5	.276/7	.067/1.7	.110/2.8	.006/0.15	T1, T3, ERG2	1,000
F9008	16	1.5	.394/10	.067/1.7	.110/2.8	.006/0.15	T1, T3, ERG2	1,000
F9009	16	1.5	.473/12	.067/1.7	.110/2.8	.006/0.15	T1, T3, ERG2	1,000
F9010	16	1.5	.709/18	.067/1.7	.110/2.8	.006/0.15	T1, T3, ERG2	1,000
F9011	14	2.5	.276/7	.087/2.2	.139/3.4	.006/0.15	T1, T3, ERG2	1,000
F9012	14	2.5	.394/10	.087/2.2	.139/3.4	.006/0.15	T1, T3, ERG2	1,000
F9013	14	2.5	.472/12	.087/2.2	.139/3.4	.006/0.15	T1, T3, ERG2	1,000
F9014	14	2.5	.709/18	.087/2.2	.139/3.4	.006/0.15	T1, T3, ERG2	1,000
F9015	12	4	.354/9	.110/2.8	.158/4	.008/0.2	T3, ERG2	1,000
F9016	12	4	.472/12	.110/2.8	.158/4	.008/0.2	T3, ERG2	1,000
F9017	12	4	.591/15	.110/2.8	.158/4	.008/0.2	T3, ERG2	1,000
F9018	12	4	.709/18	.110/2.8	.158/4	.008/0.2	T3, ERG2	1,000
F9019	10	6	.472/12	.138/3.5	.185/4.7	.008/0.2	T3, ERG2	1,000
F9020	10	6	.591/15	.138/3.5	.185/4.7	.008/0.2	T3, ERG2	1,000
F9021	10	6	.709/18	.138/3.5	.185/4.7	.008/0.2	T3, ERG2	1,000
F9022	8	10	.472/12	.177/4.5	.228/5.8	.008/0.2	ERG2	500
F9023	8	10	.591/15	.177/4.5	.228/5.8	.008/0.2	ERG2	500
F9024	8	10	.709/18	.177/4.5	.228/5.8	.008/0.2	ERG2	500
F9025	6	16	.472/12	.228/5.8	.295/7.5	.008/0.2	ERG2	250
F9026	6	16	.591/15	.228/5.8	.295/7.5	.008/0.2	ERG2	250
F9027	6	16	.709/18	.228/5.8	.295/7.5	.008/0.2	ERG2	250
F9028	6	16	.984/25	.228/5.8	.295/7.5	.008/0.2	ERG2	250
F9029	6	16	1.26/32	.228/5.8	.295/7.5	.008/0.2	ERG2	250
F9030	4	25	.591/15	.287/7.3	.374/9.5	.010/.25	ERG2	100
F9031	4	25	.709/18	.287/7.3	.374/9.5	.010/.25	ERG2	100
F9032	4	25	.984/25	.287/7.3	.374/9.5	.010/.25	ERG2	100
F9033	4	25	1.26/32	.287/7.3	.374/9.5	.010/.25	ERG2	100
F9034	2	35	.709/18	.327/8.3	.433/11	.010/.25	ERG2	100
F9035	2	35	.984/25	.327/8.3	.433/11	.010/.25	ERG2	100
F9036	2	35	1.26/32	.327/8.3	.433/11	.010/.25	ERG2	100
F9037	1/0	50	.709/18	.406/10.3	.512/13	.012/0.3	ERG2	100
F9038	1/0	50	.984/25	.406/10.3	.512/13	.012/0.3	ERG2	100
F9039	1/0	50	1.18/30	.406/10.3	.512/13	.012/0.3	ERG2	100

Thomas & Betts

United States
Tel: 901.252.8000
800.816.7809
Fax: 901.252.1354

Technical Services
Tel: 888.862.3289

Convenient 20-count packaging! Sta-Kon® Mini-Pack Terminals



- Wire ranges from 22 AWG to 10 AWG
- Vinyl insulated ring and forked-tongued terminals, female disconnects, butt-type splice connectors

NOTE: "CP" designates mini-pack quantities. Refer to other catalog pages for description and dimensional information.

CAT. NO.	UNIT QTY.	PKG. QTY.	WIRE RANGE	BOLT HOLE
18RA-6FCP	20	100	22-18	#6
18RA-8CP	20	100	22-18	#8
18RA-10CP	20	100	22-18	#10
14RB-6CP	20	100	16-14	#6
14RB-8CP	20	100	16-14	#8
14RB-10CP	20	100	16-14	#10
10RC-10CP	20	100	12-10	#10
10RC-14CP	20	100	12-10	1/4
18RA-8FCP	20	100	22-18	#8
18RA-10FCP	20	100	22-18	#10
14RB-6FCP	20	100	16-14	#6
14RB-8FCP	20	100	16-14	#8
14RB-10FCP	20	100	16-14	#10
10RC-8FCP	20	100	12-10	#8
10RC-10FCP	20	100	12-10	10
2RA18XCP	20	100	22-18	—
2RB14XCP	20	100	16-14	—
2RC10XCP	20	100	12-10	—
18RA-250FCP	20	100	22-18	—
14RB-250FCP	20	100	16-14	—
10RC-250FCP	20	100	12-10	—

Perfect for residential or light commercial installations!

Sta-Kit

- Assortment of popular Sta-Kon® vinyl terminals
- Kit includes a WT112M crimping tool
- Includes cable ties and wire marker book

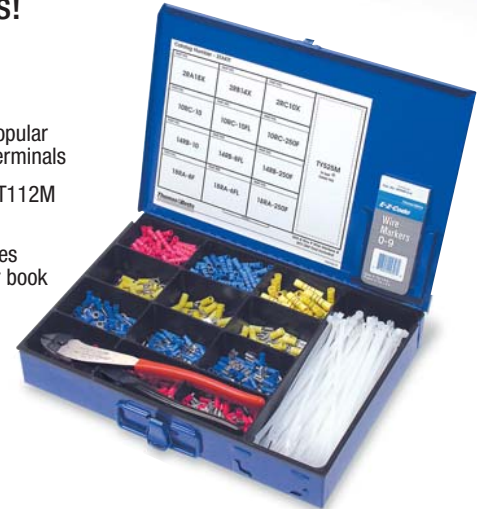

CAT. NO.	DESCRIPTION	PKG. QTY.
STAKIT	Assortment of Sta-Kon® vinyl terminals, splices and disconnects. Includes crimp tool, cable ties and wire marker book	1

Lightweight, durable, nylon construction!

Sta-Org® Terminal and Splice Organizer Kit

- Ideal for contractors, OEMs or any other user of terminals and splices
- Slips in a tool box or sits on your bench — only 6.6"L x 3" dia.
- Bench-mountable (hardware included)

Kit Contents

- (1) blue nylon organizer/carrier
- (6) see-through nylon canisters with lids
- (20) 12-10 AWG vinyl ring terminals (Cat. No. 10RC-10)
- (25) 18-14 AWG vinyl ring terminals (Cat. No. 14RB-10)
- (15) 12-10 AWG vinyl butt splices (Cat. No. 2RC-10X)
- (25) 18-14 AWG vinyl butt splices (Cat. No. 2RB-14X)
- (20) 12-10 AWG vinyl fork terminals (Cat. No. 10RC-10F)
- (25) 18-14 AWG vinyl fork terminals (Cat. No. 14RB-10F)



CAT. NO.	DESCRIPTION	PKG. QTY.
STA-ORG	Sta-Kon® Sta-Org® Terminal and Splice Organizer Kit	1

Sta-Kon®

Application Tools

Recommended Tools

The Shure-Stake® mechanism on mechanical ratchet tools and power tools prevents the dies from releasing the terminal until the proper compression has been completed. With this method, an operator achieves a reliable crimp every time. Thomas & Betts tooling techniques correctly match tools, wire size, and terminal to produce optimum mechanical and electrical performance.

Plier type if installations are fewer than 20 per day



WT112M

Ratchet type if installations are more than 20 per day



ERG2001

Power type if installations are more than 200 per day



12050



Used for installation of various Sta-Kon® terminal series.

Plier Type Tools



WT110M



WT111M



WT112M



WT161M



WT2000

CAT. NO.	DESCRIPTION	PKG. QTY.
WT110M	A, B, C non-insulated terminal and splices and A, B non-insulated terminals with insulation grip	1
WT111M	A, B, C, PT non-insulated terminal and splices; includes cutters	1
WT112M	A, B, C non-insulated and RA, RB, RC insulated nylon and vinyl terminal and splices; includes cutters	1
WT161M	A, B, C, PT non-insulated terminal and splices; includes plier grip and cutters	1
WT2000	A, B, C, AB, PT, RA, RB, RC insulated and non-insulated terminal and splices; includes wire cutters, bolt cutters and wire stripper	1

Thomas & Betts

www.tnb.com

United States
Tel: 901.252.8000
800.816.7809
Fax: 901.252.1354

Technical Services
Tel: 888.862.3289

Ergonomically designed handles let user get a grip on safety.

For easy visual verification of crimps, integrity dots are embossed on the top and bottom of the terminal.

Toggle action increases mechanical gain, which dramatically reduces handle force — and the stress on your hands.

Advanced ergonomic design of handle distributes the force more evenly across the hand.

Color-coded die nests on both the right and left sides of the tool are included for insulated terminals.

Shure-Stake® mechanism ensures a complete crimp cycle before it releases the tool.

Rubberized thermoplastic handle combines maximum friction with a soft, comfortable feel that reduces muscle tension.



ERG2001

Comfort Crimp® Terminal Tool

Concerned about safety? Down time? Health care costs?

The Thomas & Betts ergonomically-designed Comfort Crimp® tool is designed to help reduce the risk of carpal tunnel syndrome, the cause of almost one out of every two industrial injuries.

This tool's unique design delivers the same reliable crimp with up to 60% less handle force than other terminal hand tools, so you won't have to sacrifice your hand to make a successful crimp. We've researched the tool components to provide maximum comfort to the operator while ensuring a complete crimp.

Just wrap your hands around our Comfort Crimp® terminal tool. It's such a relief you won't want to handle any other tool ever again.



ERG2002



ERG2007



ERG2004



ERG2008



ERG2005

CAT. NO.	FOR USE WITH STA-KON® SERIES	PKG. QTY.
ERG2001	RA, RB, RC Nylon & vinyl terminals, splices & disconnects	1
ERG2002	A, B, C Non-insulated terminals, splices, disconnects	1
ERG2004	A,B and C Flag terminals	1
ERG2005	B, C, D, E Non-insulated terminals, splices, (D & E tubular only)	1
ERG2006	RA, RB .110 Disconnects and RAX Terminals	1
ERG2007	RD & RE Insulated terminals (tubular only)	1
ERG2008	Non-insulated terminals #8-1/0 AWG (tubular only)	1

NOTE: Contact Tool Services for gauging.

WT1377 Ratchet Hand Tool

Correct compression every time — the Shure-Stake® mechanism principle prevents opening of the handles until full staking action is completed. Installs self-insulated and non-insulated Sta-Kon® terminal series in the #26–10 AWG wire range.



CAT. NO.	FOR USE WITH STA-KON® SERIES	PKG. QTY.
WT1377	NW Ring Terminals	1

ERG2006 Hand Tool



CAT. NO.	FOR USE WITH STA-KON® SERIES	PKG. QTY.
ERG2006	RZ, RV Terminals/Splices RA, RB .110 insulated disconnects	1

ERG1255 Ratchet Hand Tool



CAT. NO.	FOR USE WITH STA-KON® SERIES	PKG. QTY.
ERG1255	RA, RB, RC Heat-Shrinkable nylon insulated terminals, butt splices, and disconnects	1

WT2130A Ratchet Hand Tool



CAT. NO.	FOR USE WITH STA-KON® SERIES	PKG. QTY.
WT2130A	RC, RBC and RD insulated terminals, RC6, RP7 wire joints	1

WT3185 Ratchet Hand Tool



CAT. NO.	FOR USE WITH STA-KON® SERIES	PKG. QTY.
WT3185	For 8 AWG to 250 MCM Non-Insulated Sta-Kon® Terminals	1

NOTE: For gauging information, contact Tool Services.

WT129 Flag Terminal Type Hand Tool



CAT. NO.	FOR USE WITH STA-KON® SERIES	PKG. QTY.
WT129	D, E, F & G Non-Insulated Flag Terminals	1



Single operation to cut and strip at the same time!

SWS01/DWS02 Wire Stripping/Cutting Tools

- Automatic adjustment to the diameter of the wire, with neither setting nor selection
- Sharply cuts and strips insulator without damaging the conductors
- DWS02 is a double-side stripper

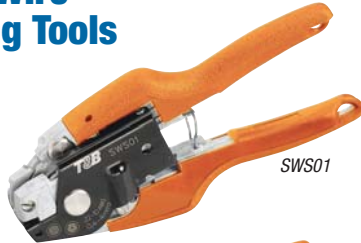

SWS01



DWS02

CAT. NO.	DESCRIPTION	PKG. QTY.
SWS01	Single-Side Stripper	1
DWS02	Double-Side Stripper	1

Integral wire cutter lets user cut and strip with the same tool!

Sta-Kon® ERG1-WS Wire Stripping/ Cutting Tool

- Interchangeable cassettes enable the user to strip a wide range of insulations without having to change tools
- Tool automatically strips wire to preset length



"V" Blade Cassette

CAT. NO.	DESCRIPTION	PKG. QTY.
ERG1-WS	Ergonomic Wire Stripping Tool	1
SBC-1	Replacement Straight Blade Cassette	1
VBC-1	Replacement "V" Blade Cassette	1

ERG1-WS Wire Stripping/Cutting Tool is shipped with one Straight Blade Cassette. "V" Blade Cassettes sold separately.

WT115A Toggle-Type Hand Tool



CAT. NO.	FOR USE WITH STA-KON® SERIES	PKG. QTY.
WT115A	D, E, F & G Non-Insulated Terminals	1

TBM6 & TBM6S Toggle-Type Hand Tools

Installing Dies for Non-Insulated Code and Aircraft Sta-Kon® Terminals

CAT. NO.		TERM. SIZE
NEST STATIONARY DIE	INDENTOR MOVABLE DIE	
11803		D, E (Tubular)
11805		E (Braze), F (Tubular)
11806	11802	F (Braze), G
11807		H
11808		J
11809		K
11810		L
11811		M

Installing Dies for Nylon Insulated Sta-Kon® Terminals TBM6 & TM6S Tool

DIE SET CAT. NO.	TERM. SIZE
11821	RD (Tubular)
11822	RD (Braze Seam) RE (Tubular)
11823	RF
11824	RG
11825	RH
11826	RJ
11827	RK
11828	RL
11829	RM



TBM6

CAT. NO.	FOR USE WITH STA-KON® SERIES	PKG. QTY.
TBM6	D through M, RD through RM	1
TBM6S	D through M, RD through RM with Shure-Stake®	1

Dies not included

Sta-Kon®

Application Tools

Safe, fast, high-volume crimping machine!

Shure-Stake® Auto-Feed Tool

- Shure-Stake® mechanism
- Fully guarded foot pedal
- Clear plastic safety guard over die area
- Dies color coded to terminals
- #26–10 AWG wire range
- Installs insulated and non-insulated terminals and disconnects



CAT. NO.	DESCRIPTION	PKG. QTY.
12050	Compact, pneumatically operated unit for crimping tape-mounted STA-KON® terminals; equipped with a Shure-Stake® mechanism, which ensures a full compression each time	1

Space Requirement: 30" W x 20" H x 20" D

Weight: 55 lbs.

Air Pressure: 90–125 psi input air supply

Installing Dies for 12050

STA-KON® TERMINAL TYPE	AWG WIRE SIZE	DIE CAT. NO.	PKG. QTY.
RA — NYLON	22–18	12051	
RA — VINYL	22–18	12054*	1
RA DISCONNECT	22–18	12061	1
RB — NYLON	16–14	12052	1
RB — VINYL	16–14	12055*	1
RB DISCONNECT	16–14	12062	1
RC — NYLON AND VINYL INSULATED	12–10	12056	1
A — NON-INSULATED	22–18	12057	1
B — NON-INSULATED	16–14	12058	1
C — NON-INSULATED	12–10	12059	1
C DISCONNECT, NON-INSUL.	12–10	12060	1
RV — RZ	26–24	683-54335	1

*Can also be used on nylon.



Tooling for Sta-Kon® Plastic Strip Terminals



CAT. NO.	DESCRIPTION	WIRE RANGE (AWG)	STD. PKG. QTY.
EBP22-10	Bench Press for Plastic Strip Terminals	22-10	1
Crimp Dies*			
RAH22-16	Red Terminals Die	22-16	1
XBAH16-14	Blue Terminals Die	16-14	1
YAH12-10	Yellow Terminals Die	12-10	1

*Dies sold separately

Thomas & Betts

United States
Tel: 901.252.8000
800.816.7809
Fax: 901.252.1354

Technical Services
Tel: 888.862.3289

1½ tons of grip that weighs less than 3 pounds!

Battery-Powered Crimping Tool — BAT22-6

T&B's newest battery-powered tool is fast and portable for making high-volume and difficult-to-reach terminal installations in a snap. The Sta-Kon® BAT22-6 delivers 1.5 tons of crimping force with an easy, pushbutton trigger. The lightweight, ergonomic design minimizes the risk of repetitive motion injuries that can occur with traditional hand crimping tools. And at less than three pounds, one-hand operation is easy while still packing enough power to crimp up to 6 AWG terminals in seconds.

- Interchangeable dies can be quickly changed to crimp non-insulated and insulated terminals up to 6 AWG
- Dies are the same as our hand tools — crimps will be exactly the same between Sta-Kon® hand tools such as our ERG2001 and the new BAT22-6
- 360° rotating head gives the user the added flexibility when crimping hard-to-reach connections
- Short cycle time equates to crimping times of less than two seconds
- Quick, lightweight, and maneuverable
- NiCd battery operation provides long-lasting battery life to complete up to 150 crimps on a single charge
- Extra battery and charger are included with the tool, ensuring round-the-clock operation
- Battery charger provides full battery life in under an hour
- Linear crimping motion gives a symmetric, high-quality crimp every time



NEW!

Uses the exact dies of the Comfort Crimp line of ergonomic tools for Sta-Kon® and Dragon Tooth® terminals.

Included Accessories

- Sturdy, plastic carrying case for portability
- Two 9.6V NiCd batteries and battery charger
- Sturdy tray for convenient storage of crimp dies

CAT. NO.	DESCRIPTION	PKG. QTY.
BAT22-6	Battery Crimping Tool, 1.5 Ton with 120 VAC Charger	1
Crimp Dies*		
DIE2001	Insulated 22–10 AWG Sta-Kon Terminals	1
DIE2002	Non-Insulated 22–10 AWG Sta-Kon Terminals	1
DIE2005	16–14/12–10/8–6 (Tubular Only) Sta Kon Terminals	1
DIE2007	Insulated 8–6 AWG Sta-Kon Terminals	1

*Dies sold separately.



Crimp 22–6 AWG terminals!

BAIR22-6 Bench-Mounted Air Tool

- 1.5 tons of grip
- Bench-mounted heavy-duty air tool
- Short cycle time
- Shure-Stake® mechanism
- Foot actuated
- Accepts T&B standard hand tool dies
- Installs Sta-Kon® and Spec-Kon® terminals as well as ferrules and Dragon Tooth® connectors



CAT. NO.	DESCRIPTION	PKG. QTY.
BAIR22-6	Heavy-duty, high-speed production tool installs a wide range of Sta-Kon® terminals, from 26-6 gauge; uses the ERG2000 series dies for both non-insulated and insulated terminals; supplied complete with foot pedal, air hose/air lubricator	1

Crimp Dies*

DIE2001	Insulated 22–10 AWG Sta-Kon Terminals	1
DIE2002	Non-Insulated 22–10 AWG Sta-Kon Terminals	1
DIE2005	Non-Insulated 16–10/8–6 (Tubular Only) Sta-Kon Terminals	1
DIE2007	Insulated 8–6 AWG Sta-Kon Terminals (Tubular Only)	1

* Dies sold separately.

NOTE: The dies for the BAIR22-6, PAIR22-6 and BAT22-6 (page F-37) are interchangeable.

1.25 tons of portable force!

PAIR22-6 Portable Air Hydraulic Tool



- Crimps 22-6 AWG terminals
- Portable heavy-duty air tool
- Installs Sta-Kon® terminals as well as ferrules and Dragon Tooth® connectors
- Interchangeable dies
- Open yoke enables easy access to insert and remove terminals for crimping

CAT. NO.	DESCRIPTION	PKG. QTY.
PAIR22-6	Open yoke; hand actuated	1

Crimp Dies*

DIE2001	Insulated 22–10 AWG Sta-Kon Terminals	1
DIE2002	Non-Insulated 22–10 AWG Sta-Kon Terminals	1
DIE2005	Non-Insulated 16–10/8–6 (Tubular Only) Sta-Kon Terminals	1
DIE2007	Insulated 8–6 AWG Sta-Kon Terminals (Tubular Only)	1

* Dies sold separately.

NOTE: The dies for the BAIR22-6, PAIR22-6 and BAT22-6 are interchangeable.

Crimps 8 AWG–250 mcm! Air-Operated Bench-Mounted Tool

- Convenience and Economy

The tool accepts a full range of interchangeable dies, the same as used in the TBM6 or TBM6S tools. To install the dies, simply pull the spring-loaded pin and remove the indenter die. Then, flex the retaining spring and remove the die nest.

- Shure-Stake® Mechanism Means Quality Connections

The Shure-Stake® mechanism senses inlet air pressure, and if insufficient, is designed to prevent the tool from cycling. Thus you avoid “undercrimping.” An 85–90 psi air pressure source is required.

- Safety Features Increase Productivity, Reduce Downtime

Safety features include a guard over the die area, an air shutdown switch activated by a slight push with the finger, and an enclosed foot pedal designed to prevent unwanted tool operation. In addition, the tool may be bench-mounted for stability and control. For convenience when crimping large size terminals on heavy wire, the head assembly may overhang the workbench.

CAT. NO.	DESCRIPTION	PKG. QTY.
25000	This compact heavy-duty air tool installs nylon insulated Sta-Kon® terminals on wire sizes from 8 AWG to 250 mcm; non-insulated styles are also installed just as quickly and dependably; Heavy-duty air tool installs non-insulated and insulated Sta-Kon® terminals from 8 AWG to 250 mcm	1

NOTE: This tool uses the same dies as the TBM6 and TBM6S hand tools on page F-35.

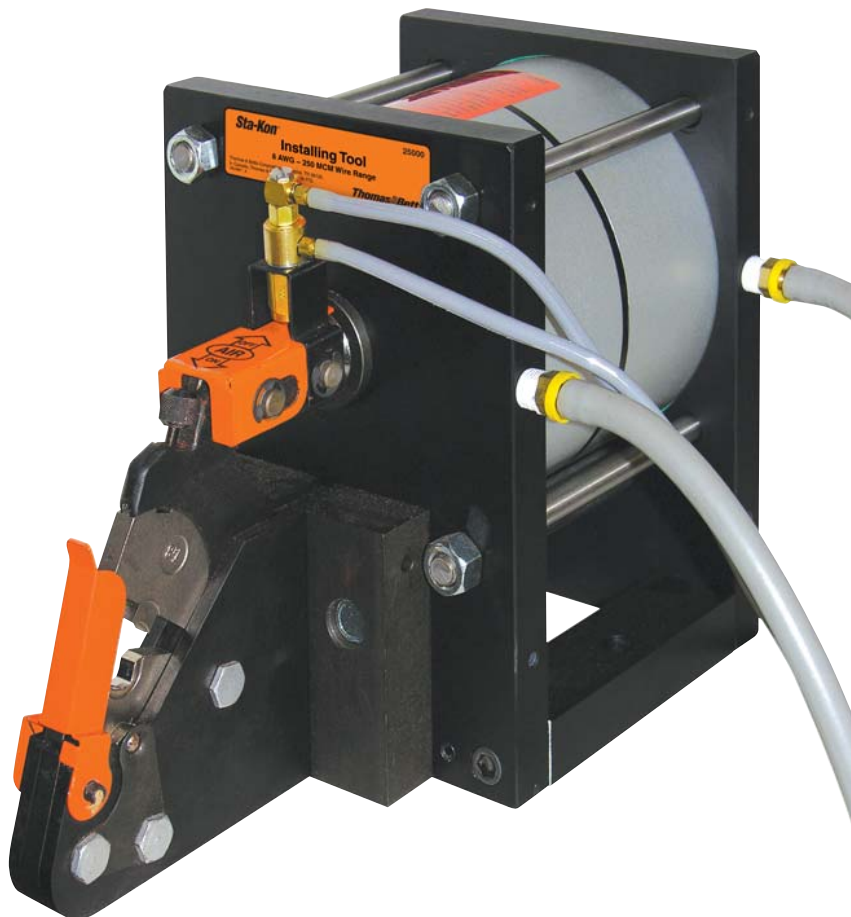

Sta-Kon®

Application Tools

Installs insulated and non-insulated Sta-Kon® Terminals!

12-Ton Crimping Tool



CAT. NO.	DESCRIPTION	PKG. QTY.
13400	12-ton crimping tool for installing both insulated and non-insulated Sta-Kon® terminals #8 to 250 mcm (dies ordered separately)	1

Military listed and 12 tons of crimping power!

12-Ton Crimping Tool (Military Spec. MS25441-1)



13642M

CAT. NO.	DESCRIPTION	PKG. QTY.
13642M	Hydraulic-operated 12-ton tool installs #8 through 250 mcm Sta-Kon® terminals (dies ordered separately)	1

Hex Dies for Non-Insulated Sta-Kon® Terminals to Fit 13642M and 13400

DIE CAT. NO.		STA-KON® SIZE	WIRE SIZE	HEX DIE CODE
FOR TUBULAR TERM	FOR BRAZED SEAM			
11732	—	D	8	21
—	11733	D	8	24
11733	—	E	6	24
—	11734	E	6	29
11734	—	F	4	29
—	11735	F	4	33
11736	—	G	2-1	37
11737	—	H	1/0	42
11738	—	J	2/0	45
11739	—	K	3/0	50
11740	—	L	4/0	54
11771	—	M	250 mcm	62

Installing Dies for Insulated Sta-Kon® Terminals to Fit 13642M (Military Listed)

DIE CAT. NO.	STA-KON SIZE	WIRE SIZE	PKG. QTY.
21707M	RD	8	1
21708M	RE	6	1
21709M	RF	4	1
21710M	RG	2-1	1
21711M	RH	1/0	1
21712M	RJ	2/0	1
21713M	RK	3/0	1
21714M	RL	4/0	1
21715M	RM	250 mcm	1

Hex Dies for Non-Insulated Sta-Kon® Terminals to Fit 13642M (Military Listed)

DIE CAT. NO.	STA-KON SIZE	WIRE SIZE	PKG. QTY.
11781M	D	8	1
11782M	E	6AN	1
11783M	F	4AN	1
11784M	G	2AN	1
11785M	H	1AN	1
11786M	J	1/0AN	1
11787M	K	2/0AN	1
11788M	L	3/0AN	1
11789M	M	4/0AN	1

Indent Style Dies for Sta-Kon® Brazed Seam Non-Insulated Terminals to Fit 13642M and 13400

NEST CAT. NO.	INDENT. CAT. NO.	STA-KON® SIZE	WIRE SIZE	PKG. QTY.
13643	—	D	8	1
13644	13650	E	6	1
13645	—	F	4	1

Indent Style Dies for Sta-Kon® Tubular Non-Insulated Terminals to Fit 13642M and 13400

NEST CAT. NO.	INDENT. CAT. NO.	STA-KON® SIZE	WIRE SIZE	PKG. QTY.
13654	—	G	2-1	1
13655	—	H	1/0	1
13656	13650	J	2/0	1
13657	—	K	3/0	1
13658	—	L	4/0	1
13659	—	M	250 mcm	1

Indent Style Dies for Flag Type Sta-Kon® Terminals — Use with 13642M and 13400

NEST CAT. NO.	INDENT. CAT. NO.	STA-KON® SIZE	WIRE SIZE	PKG. QTY.
21733	—	D	8	1
21734	21731	E	6	1
21735	—	F	4	1
21736	—	G	2	1
21737	—	H	1	1
21738	21732	J	1/0	1
21739**	—	K	2/0	1
21740**	—	L	3/0	1
21741**	—	M	4/0	1

** Cat. Nos. 21739, 21740 and 21741 dies must be left in 13642 head with 21732 indenter when gauging.

Sta-Kon® Terminal Products and Tools

Thomas & Betts

www.tnb.com

United States
Tel: 901.252.8000
800.816.7809
Fax: 901.252.1354

Technical Services
Tel: 888.862.3289

13600 Electric Hydraulic Pump

- Designed for use with single-acting cylinders and tools rated for 10,000 psi operation
- Supplied with metal carrying case
- 13620 hand switch and 13619 hydraulic hose, both sold separately, required for operation

..... Specifications

- Motor: ½ hp, 115V 50–60 Hz, 10 amps
- Pumping Capacity:
170 cu. in./min. at 100 psi
32 cu. in./min. at 1,000 psi
25 cu. in./min. at 5,000 psi
18 cu. in./min. at 10,000 psi
- Reservoir Volume: 104 cu. in. (.45 gal.)
- Basic Pump Dimension: 6" x 8" x 16"
- Weight: 25 lbs.



CAT. NO.	DESCRIPTION	PKG. QTY.
13600	Electric Hydraulic Pump — hand or foot switch and non-metallic hose (sold separately) required for operation	1

13610A Electric Hydraulic Pump with Shure-Stake® Control

- Shure-Stake® control mechanism requires 9,800 psi pump pressure before recycling to prevent under-crimping
- Designed for use with single-acting cylinders and tools rated for 10,000 psi operation
- Supplied with metal carrying case



..... Specifications

- Motor Rating: ½ hp, 115V, 50-60 Hz, 12.5 amps
- Pumping Capacity:
170 cu. in./min. at 100 psi
32 cu. in./min. at 1,000 psi
25 cu. in./min. at 5,000 psi
18 cu. in./min. at 10,000 psi
- Reservoir Volume: 104 cu. in. (.45 gal.)
- Basic Pump Dimension: 8½" x 10½" x 16"
- Weight: 35 lbs.

CAT. NO.	DESCRIPTION	PKG. QTY.
13610A	Electric Hydraulic Pump with Shure-Stake® control — hand or foot switch and non-metallic hose (sold separately) required for operation	1

13810 Heavy-Duty Electric Hydraulic Pump with Shure-Stake® Control



- Designed for perfect crimps every time in heavy-duty OEM applications
- Heavy-duty OEM two-stage pump with high flow rate
- Shure-Stake® control mechanism requires 9,800 psi pump pressure before recycling to prevent under-crimping
- Requires hand or foot control (sold separately)

..... Specifications

- Motor Rating: 1½ hp, 115V, 60 Hz, 23 amps
- Pumping Capacity:
235 cu.in./min. at 200 psi
6 cu.in./min. at 8,000 psi
- Reservoir Volume: 462 cu.in./2 gal.
- Dimensions (L x W x H): 10½" x 15" x 20¾"
- Weight: 60 lbs.

CAT. NO.	DESCRIPTION	PKG. QTY.
13810	Heavy-duty electric hydraulic pump with Shure-Stake® control — hand or foot switch and non-metallic hose (sold separately) required for operation	1

Accessories for the pumps on this page

CAT. NO.	DESCRIPTION	PKG. QTY.
<i>You may also need...for 13600</i>		
13620	Hand Switch — 10 ft.	1
13589A	Foot Switch — 10 ft.	1
13619	10 ft. Non-Metallic Hose	1
13618	20 ft. Non-Metallic Hose	1
13600S	"Sled" type stand for 13600 pump	1

<i>You may also need...for 13610A & 13810</i>		
13611	Hand Switch — 10 ft.	1
13612	Foot Switch — 10 ft.	1
13619	10 ft. Non-Metallic Hose	1
13618	20 ft. Non-Metallic Hose	1

Critical information for determining the products you need!

TERMINAL TYPE	TERMINAL SERIES	PLIERS					ERGONOMIC RATCHET HAND TOOLS						RATCHET HAND TOOLS	
		WT110M	WT111M	WT112M	WT161M	WT2000	ERG2001	ERG2002	ERG2004	ERG2005	ERG2006	ERG1255	WT1377	WT145A
Nylon Terminals	RZZ										•			
	RA, RAX			•		•	•							•
	RB			•		•	•							•
	RBC, RC			•		•	•							•
Nylon Butt Splices	RA			•		•	•							
	RB			•		•	•							
	RC			•		•	•							
Nylon Parallel Splices	RAA					•								
	RBB					•								
	RCC					•								
All Nylon Disconnects (except .110 size)	RA			•		•	•							
	RB			•		•	•							
	RC			•		•	•							
Heat Shrinkable Terminals, Splices, Disconnects	RAS											•		
	RBS											•		
	RCS											•		
Vinyl Terminals and Splices	RA, RAA			•		•	•							
	RB, RBB			•		•	•							
	RC, RCC, RBC			•		•	•							
Bare Terminals and Splices	A,AA	•	•	•	•	•		•						
	B,BB	•	•	•	•	•		•		•				
	C,CC	•	•	•	•	•		•		•				
Wire Joints	RB			•		•	•							
	RC			•		•								
	RP			•		•								
	PT		•		•									
Hi-Temp Terminals and Splices	NW-Rings												•	
	NW-Splices												•	
Insulation Grip	A	•												
	B	•												
.110 Disconnects	A,B	•	•	•										
	RA, RB										•			
Flag Terminals	AB									•				
	C									•				
Tefzel® Terminals and Splices	RAT, RAAT			•		•								
	RBT, RBBT			•		•								
	RCT, RCCT			•		•								
Vinyl Disconnects	RA			•		•	•							
	RB			•		•	•							
	RC			•		•	•							
Bare Disconnects	A	•	•	•	•	•		•						
	B	•	•	•	•	•		•		•				
	C	•	•	•	•	•		•		•				

Tefzel® is a registered trademark of DuPont.

Die Selection Charts

Select the die numbers you need!

DESCRIPTION	TERMINAL		HAND TOOL WITH DIES	25000 AIR TOOL TBM6 — TOGGLE HAND TOOL TBM6S — TOGGLE HAND TOOL DIE CAT. NOS.		13642M (MS25441-1) AND 13400 HYDRAULIC TOOL		
	SERIES	TYPE		NEST (STATIONARY)	INDENTOR (MOVABLE)	HEX DIES	NEST	INDENTOR
Non-Insulated Terminals and Splices	D	Tubular	ERG2005	11803	11802	11781M*	13651	13650**
	D	Tubular	ERG2008	11803	11802	11781M*	13651	13650**
	D	Tubular	WT3185/WT115A	11803	11802	11732	13651	13650**
	D	Brazed	WT3185/WT115A	11803	11802	11733	13643	13650**
	E	Tubular	ERG2005	11803	11802	1182M	13652	13650**
	E	Tubular	ERG2008	11803	11802	1182M	13652	13650**
	E	Tubular	WT3185/WT115A	11803	11802	11733*	13652	13650**
	E	Brazed	WT3185/WT115A	11805	11802	11734	13644	13650**
	F	Tubular	ERG2008	11805	11802	11783	13653	13650**
	F	Tubular	WT3185/WT115A	11805	11802	11734*	13653	13650**
	F	Brazed	WT3185/WT115A	11806	11802	11735	13645	13650**
	G	Tubular	ERG2008	11806	11802	11784M*	13654	13650**
	G	Tubular	WT3185/WT115A	11806	11802	11736	13654	13650**
	H	Tubular	ERG2008	11807	11802	11785M*	13655	13650**
	H	Tubular	WT3185	11807	11802	11785M*	13655	13650**
	H	Tubular	WT3185	11807	11802	11737	13655	13650**
	J	Tubular	WT3185	11808	11802	11786M*	13656	13650**
	J	Tubular	WT3185	11808	11802	11738	13656	13650**
	K	Tubular	—	11809	11802	11787M*	13657	13650**
	K	Tubular	—	11809	11802	11739	13657	13650**
L	Tubular	—	11810	11802	11788M*	13658	13650**	
L	Tubular	—	11810	11802	11740	13658	13650**	
M	Tubular	—	11811	11802	11789M*	13659	13650**	
M	Tubular	—	11811	11802	11771	13659	13650**	
Tefzel®† Nylon Insulated Terminals and Splices	RD	Tubular	ERG2007	—	11821 (Set)	—	21707M* (Set)	—
	RD	Brazed & Tubular	—	—	11822 (Set)	—	21708M* (Set)	—
	RE	Tubular	ERG2007	—	11822 (Set)	—	21708M* (Set)	—
	RE	Brazed	—	—	11823 (Set)	—	21709M* (Set)	—
	RF	Tubular	—	—	11823 (Set)	—	21709M* (Set)	—
	RF	Brazed	—	—	11824 (Set)	—	21710M* (Set)	—
	RG	Tubular	—	—	11824 (Set)	—	21710M* (Set)	—
	RH	Tubular	—	—	11825 (Set)	—	21711M* (Set)	—
	RJ	Tubular	—	—	11826 (Set)	—	21712M* (Set)	—
	RK	Tubular	—	—	11827 (Set)	—	21713M* (Set)	—
RL	Tubular	—	—	11828 (Set)	—	21714M* (Set)	—	
RM	Tubular	—	—	11829 (Set)	—	21715M* (Set)	—	
Non-Insulated Flag Terminals	D	—	WT129	—	—	—	21733	21731
	E	—	WT129	—	—	—	21734	21731
	F	—	WT129	—	—	—	21735	21731
	G	—	WT129	—	—	—	21736	21732
	H	—	—	—	—	—	21737	21732
	J	—	—	—	—	—	21738	21732
	K	—	—	—	—	—	21739	21732
	L	—	—	—	—	—	21740	21732
M	—	—	—	—	—	21741	21732	

* Indicates military listed die.

** To order the military version, suffix the indentor catalog number with an "M" (13650M). Nest catalog number does not change.

† Tefzel® is a registered trademark of DuPont.

Stud Size and Clearance Hole Chart

STUD SIZE	2	4	6	8	10	¼	⅜	½	⅝	¾	1	
Min. hole diam. — in.	0.92	.116	.143	.169	.196	.262	.323	.388	.453	.516	.650	.775
Min. hole diam. — mm	2.337	2.946	3.632	4.292	4.978	6.655	8.204	9.855	11.506	13.106	16.510	19.685

Wire Strip Length Chart

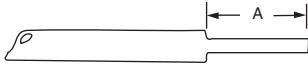

WIRE STRIP LENGTH	TERMINAL SERIES	RECOMMEND WIRE STRIP LENGTH "A" STANDARD TERMINALS
Non-Insulated	A	¼
	B	¼
	C, BC	⅜
Vinyl Insulated — Add ⅛" for Funnel Entry Type	RA	¼
	RB	¼
Nylon Insulated and Tefzel® Insulated	RC, RBC	⅜
	RA	⅜
Nylon Insulated and Tefzel® Insulated	RB	⅜
	RC, RBC	⅜
Nylon Insulated when using Aircraft and Code Wire	RD	⅜
	RE	⅜
Nylon Insulated and Tefzel® Insulated	RF	⅜
	RG	⅜
Nylon Insulated when using Aircraft and Code Wire	RH	⅜
	RJ	¾
Nylon Insulated when using Aircraft and Code Wire	RK	¾
	RL	¾
Nylon Insulated when using Aircraft and Code Wire	RM	1
	D	⅜
Nylon Insulated when using Aircraft and Code Wire	E	⅜
	F	½
Nylon Insulated when using Aircraft and Code Wire	G	⅜
	H	⅜
Nylon Insulated when using Aircraft and Code Wire	J	⅜
	K	⅜
Nylon Insulated when using Aircraft and Code Wire	L	⅜
	M	⅜

Tefzel® is a registered trademark of DuPont.

AWG OR AN	NAVY SHIPBOARD ³	INDIVIDUAL STRANDS		WHOLE CONDUCTOR		
		NO.	DIA. IN.	CIR. MIL. AREA	DIA. IN.	DIA. MM
22 Wire Size						
22	3/5 (1)	1	.025	642	.025	.635
22	3/5 (7)	7	.010	703	.030	.762
AN-22*		7	*	704	.032	.813
	½ (21)	21	.005	525	.028	.711
20 Wire Size						
20	1 (1)	1	.032	1,022	.032	.813
20		7	.012	1,024	.036	.914
20		10	.010	1,005	.040	1.016
20		19	.007	1,022	.037	.940
20		26	.006	1,034	.039	.991
AN-20*		7	*	1,119	.040	1.016
	1 (7)	7	.013	1,119	.038	.965
	1 (10)	10	.010	1,005	.038	.965
	1 (26)	26	.006	1,034	.042	1.067
18 Wire Size						
18	1½ (1)	1	.040	1,624	.040	1.016
18	1½ (7)	7	.016	1,624	.049	1.245
18	1½ (16)	16	.010	1,608	.049	1.245
18		19	.009	1,624	.046	1.168
18	1½ (41)	41	.006	1,630	.049	1.245
AN-18*	2 (7)	7	.016	1,779	.048	1.219
16 Wire Size						
16	2½ (1)	1	.051	2,583	.051	1.295
16		7	.019	2,583	.058	1.473
16		19	.012	2,601	.058	1.473
16		26	.010	2,613	.059	1.499
16		65	.006	2,580	.058	1.473
AN-16*	2½ (19)	19	.011	2,407	.061	1.549
	2½ (26)	26	.010	2,613	.061	1.549
14 Wire Size						
14		1	.064	4,107	.064	1.626
14		7	.024	4,107	.073	1.854
14		19	.015	4,107	.074	1.880
14		37	.011	4,107	.074	1.880
14		14	.009	4,157	.083	2.108
14		104	.006	4,128	.074	1.880
AN-14*		19	*	3,830	.076	1.930
	3 (7)	7	.020	2,828	.060	1.524
	3 (19)	19	.013	3,036	.063	1.600
	4 (1)	1	.064	4,107	.064	1.626
	4 (7)	7	.025	4,497	.076	1.930
	4 (19)	19	.014	3,828	.072	1.829
	4 (41)	41	.010	4,121	.077	1.956
12 Wire Size						
12		1	.081	6,530	.081	2.057
12		7	.031	6,530	.092	2.337
12		19	.019	6,530	.093	2.362
12		37	.013	6,530	.093	2.362
12		49	.012	6,593	.104	2.642
12		65	.010	6,533	.093	2.362
12		104	.008	6,574	.094	2.388
12		165	.006	6,559	.095	2.413
AN-12*	6 (19)	19	.018	6,088	.096	2.438
	6 (7)	7	.031	6,512	.092	2.337
	6 (65)	65	.010	6,533	.097	2.964
10 Wire Size						
10		1	.102	10,380	.102	2.591
10		7	.039	10,380	.116	2.946
10		19	.023	10,380	.117	2.972
10		37	.017	10,443	.117	2.972
10		49	.015	10,445	.131	2.327
10		104	.010	10,452	.116	2.946
AN-10*		37	*	10,380	.117	2.972
	9 (7)	7	.036	9,016	.108	2.743
	9 (37)	37	.016	9,402	.109	2.769
	9 (90)	90	.010	9,045	.120	3.048

* MIL-W-5086. * Strand diameter not specified. 3 MIL-E-16366A.

United States
Tel: 901.252.8000
800.816.7809
Fax: 901.252.1354

Technical Services
Tel: 888.862.3289

Thomas & Betts

www.tnb.com

Wire Guide Tables

AWG OR AN	NAVY SHIPBOARD ³	INDIVIDUAL STRANDS		WHOLE CONDUCTOR		
		NO.	DIA. IN.	CIR. MIL. AREA	DIA. IN.	DIA. MM
9 Wire Size						
9		7	.043	13,090	.130	3.302
	14 (7)	7	.045	14,340	.136	3.454
8 Wire Size						
8		7	.049	16,510	.146	3.712
8		19	.030	16,510	.148	3.763
8		37	.021	16,510	.148	3.763
7 Wire Size						
7		1	.144	20,820	.144	3.662
	14 (7)	7	.045	14,340	.136	3.454
	14 (140)	140	.010	14,070	.145	3.787
6 Wire Size						
6		7	.061	25,250	.184	4.672
6		19	.037	26,250	.186	4.722
6		37	.027	26,250	.186	4.722
6		49	.023	26,146	.208	5.283
6		661	.006	26,274	.259	6.579
5 Wire Size						
5		1	.181	33,100	.181	4.595
	20 (49)	7x7	.020	19,800	.180	4.570
	23 (7)	7	.057	22,800	.171	4.345
	23 (228)	19x12	.010	22,190	.190	4.830
	26 (49)	7x7	.023	26,250	.210	5.330
4 Wire Size						
4		7	.077	41,740	.232	5.891
4		19	.047	41,740	.235	5.967
4		37	.034	41,740	.235	5.967
3 Wire Size						
3		1	.229	52,630	.229	5.819
	30 (304)	19x16	.010	30,550	.220	5.590
	33 (336)	7x48	.010	33,370	.235	5.967
	40 (19)	19	.045	38,910	.226	5.742
	42 (49)	7x7	.029	41,740	.260	6.600
	42 (209)	19x11	.014	42,110	.260	6.600
	50 (19)	19	.051	49,080	.254	6.452
2 Wire Size						
2		7	.097	66,370	.292	7.421
2		19	.059	66,370	.296	7.522
2		37	.042	66,370	.297	7.548
2		49	.037	66,356	.331	8.405
2		133	.022	66,140	.335	8.507
AN-2*		663	*	66,832	.345	8.767
	53 (532)	19x28	.010	53,470	.304	7.772
	60 (37)	37	.040	60,090	.282	7.161
	60 (304)	19x16	.014	61,260	.310	7.870
	66 (133)	19x7	.022	66,370	.330	8.380
	75 (37)	37	.045	75,780	.317	8.048
1 Wire Size						
1		7	.109	83,690	.328	8.333
1		19	.066	83,690	.332	8.431
1		37	.048	83,690	.333	8.456
1		61	.037	83,690	.333	8.456
1		133	.025	83,690	.377	9.578
1		259	.018	83,916	.378	9.603
AN-1*		812	*	81,807	.384	9.752
	83 (418)	19x22	.014	84,230	.380	9.650
	84 (2,107)	2107	*	83,690	.410	10.41

* MIL-W-5086.

* Strand diameter not specified.

³MIL-E-16366 A

Wire Guide Tables

AWG OR AN	NAVY SHIPBOARD ³	INDIVIDUAL STRANDS		WHOLE CONDUCTOR		
		NO.	DIA. IN.	CIR. MIL. AREA	DIA. IN.	DIA. MM
1/0 Wire Size						
1/0		7	.123	105,500	.368	9.343
1/0		19	.075	105,500	.373	9.476
1/0		37	.053	105,500	.374	9.502
1/0		61	.042	105,500	.374	9.502
1/0		133	.028	105,761	.423	10.721
1/0		259	.020	105,672	.424	10.772
AN-0*		1,033	*	104,118	.432	10.971
	100 (61)	61	.040	99,060	.363	9.216
	105 (259)	37x7	*	105,500	.410	10.410
2/0 Wire Size						
	105 (2,646)	2,646	*	105,500	.460	11.680
2/0		7	.138	133,100	.414	10.512
2/0		19	.084	133,100	.419	10.639
2/0		37	.060	133,100	.420	10.670
2/0		61	.047	133,100	.420	10.670
2/0		133	.032	132,800	.474	12.042
2/0		259	.023	133,462	.477	12.118
AN-00*		1,327	*	133,665	.490	12.450
	125 (61)	61	.045	124,900	.407	10.338
	133 (259)	37x7	*	133,100	.460	11.680
	133 (684)	19x36	.014	137,800	.480	12.190
	133 (3,325)	3,325	*	133,100	.520	13.210
	150 (61)	61	.051	157,600	.457	11.608
3/0 Wire Size						
3/0		7	.155	167,800	.464	11.782
3/0		19	.094	167,800	.470	11.940
3/0		37	.067	167,800	.471	11.965
3/0		61	.052	167,800	.472	11.991
3/0		133	.036	167,607	.533	13.536
3/0		259	.026	167,402	.536	13.612
3/0		4,227	.006	168,023	.610	15.490
	150 (760)	19x40	.014	153,100	.510	12.950
	168 (427)	61x7	*	167,800	.520	13.210
4/0 Wire Size						
4/0		7	.174	211,600	.522	13.261
4/0		19	.106	211,600	.528	13.413
4/0		37	.076	211,600	.529	13.439
4/0		61	.059	211,600	.530	13.460
4/0		133	.040	211,736	.599	15.219
4/0		259	.029	211,845	.601	15.265
AN-000*		1,661	*	167,332	.548	13.923
	200 (61)	61	.057	198,700	.514	13.652
	200 (988)	19x52	.014	199,100	.580	14.730
250 MCM Wire Size						
250,000		19	.115	250,000	.574	14.582
250,000		37	2	250,000	.575	14.607
250,000		61	.064	250,000	.576	14.632
250,000		91	.052	250,000	.576	14.632
AN-0000*		2,104	*	211,954	.615	15.617
	220 (259)	37x7	.029	220,700	.610	15.490
	250 (61)	61	.064	250,000	.577	14.658

* MIL-W-5086.

* Strand diameter not specified.

³MIL-E-16366 A.

Military Standard Cross Reference

MIL-T-7928	CAT. NO. T&B
MS-25036	CLASS 1 & 2
-101	RA333
-102	RA853
-103	RA873
-104	RA723
-105	RA733
-106	RB1333
-107	RB853
-108	RB873
-109	RB723
-110	RB733
-111	RC333
-112	RC363
-113	RC703
-114	RC733
-115	RD10361
-116	RD10711
-117	RD10721
-118	RD10731
-119	RE10261
-120	RE10711
-121	RE10721
-122	RE10731
-123	RF10711
-124	RF10721
-125	RF10731
-126	RG9711
-127	RG9731
-128	RG9751
-129	RH9711
-130	RH9731
-131	RH9751
-132	RJ9711
-133	RJ9731
-135	RK9721
-136	RK9731
-137	RK9751
-138	RL9731
-139	RL9751
-140	RM9731
-141	RM9751
-142	—
-143	—
-144	—
-145	—
-146	—
-147	—
-148	RA323
-149	RA863
-150	RA713
-151	RA753
-152	RB1323
-153	RB863
-154	RB713
-155	RB753
-156	RC863
-157	RC713
-158	RC753

MIL-T-7928	CAT. NO. T&B
MS-20659	CLASS 1 & 2
-101	A85G
-102	A87G
-103	B85G
-104	B87G
-105	C26
-106	C70
-107	D10361
-108	D10721
-109	E10711
-110	E10731
-111	F10711
-112	F10731
-113	G971
-114	G973
-115	H971
-116	H973
-117	J971
-118	J973
-119	K972
-120	K973
-121	L973
-122	L975
-123	M973
-124	M975
-128	C73
-129	D10731
-130	E10261
-131	E10721
-132	F10721
-133	G975
-134	H975
-135	J975
-136	K975
-140	D10161
-141	D10711
-144	F10261
-146	G926
-147	G972
-148	G974
-149	H972
-151	J972
-152	J974
-153	K971
-154	K974
-155	L972
-156	L974
-157	M972
-158	M974
-165	C33
-166	C75

MIL-T-22909 MS-90485	CAT. NO. T&B
-8	11781M
-6	11782M
-4	11783M
-2	11784M
-1	11785M
-01	11786M
-02	11787M
-03	11788M
-04	11789M
MIL-T-7928 MS-17143	CAT. NO. T&B
-1	RA480
-2	RB480
-3	RC480
-4	RA481
-5	RB481
-6	RC481
-7	RA482
-8	RB482
-9	RC482
-10	RA483
-11	RB483
-12	RC483
-13	RA484
-14	RB484
-15	RC484
-16	RA485
-17	RB485
-19	RA486
-20	RB486

MIL-T-7928 MS-21004	CAT. NO. T&B
-1	A486
-2	A483
-3	A482
-4	A481
-5	A485
-6	A484
-7	A480
-8	B486
-9	B483
-10	B482
-11	B481
-12	B485
-13	B484
-14	B480
-15	C486
-16	C483
-17	C482
-18	C481
-19	C485
-20	C484
-21	C480
MIL-T-22909 MS-23002	CAT. NO. T&B
-8	21707M
-6	21708M
-4	21709M
-2	21710M
-1	21711M
-01	21712M
-02	21713M
-03	21714M
-04	21715M

Cross Reference for Packaging

NOTE: All catalog numbers do not appear in this cross reference. This means it may not be available in one of the package options.

CAT. NO. T&B DISTRIBUTOR PACKAGE	CAT. NO. T&B BULK PACKAGE	CAT. NO. T&B DISTRIBUTOR PACKAGE	CAT. NO. T&B BULK PACKAGE	CAT. NO. T&B DISTRIBUTOR PACKAGE	CAT. NO. T&B BULK PACKAGE	CAT. NO. T&B DISTRIBUTOR PACKAGE	CAT. NO. T&B BULK PACKAGE	CAT. NO. T&B DISTRIBUTOR PACKAGE	CAT. NO. T&B BULK PACKAGE
A18-6	A85	C10-14	C71	RB14-8	RB863	RF4-38	RF737	14RB-6F	RB647
A18-6F	A116	C10-14F	C116	RB14-8F	RB1123	RF4-516	RF727	14RB-6FL	RB2207
A18-6FL	A221	C10-38	C73	RB14-8FL	RB2233	RG2-10	RG267	14RB-6FLX	RB2207-200
A18-8	A86	C10-250A	C252G	RB14-8FS	RB1223	RG2-12	RG757	14RB-6FX	RB647-200
A18-8F	A114	C10-250F	C250	RB14-8X	RB864	RG2-14	RG717	14RB-6X	RB857-200
A18-8FL	A224	C10-516	C70	RB14-10	RB873	RG2-38	RG737	14RB-8	RB867
A18-10	A87	D8-10	D36	RB14-10F	RB1153	RG2-516	RG727	14RB-8F	RB657
A18-10F	A115	D8-12	D75	RB14-10FL	RB2253	RP12	RP7	14RB-8FL	RB2237
A18-10FL	A225	D8-14	D71	RB14-10FS	RB1253	2A-18	AA2	14RB-8FLX	RB2237-200
A18-12	A75	D8-38	D73	RB14-10X	RB874	2A20	RAA24	14RB-8FX	RB657-200
A18-14	A71	D8-516	D72	RB14-12	RB753	2A22-20	A1A	14RB-8X	RB867-200
A18-38	A73	E6-10	E26	RB14-14	RB713	2B-14	BB2	14RB-10	RB877
A18-110F	A10	E6-12	E75	RB14-14F	RB1163	2B-16	RBB25	14RB-10F	RB1157
A18-111F	A11	E6-14	E71	RB14-14X	RB714	2B18-16	B1B	14RB-10FL	RB2257
A18-250	A250	E6-38	E73	RB14-38	RB733	2C-10	CC2	14RB-10FLX	RB2257-200
A18-250A	A252G	E6-516	E72	RB14-38X	RB734	2C-12	RCC26	14RB-10FX	RB1157-200
A18-251T	A251	F4-10	F26	RB14-47PT	RB147PT	2C14-12	C1C	14RB-10X	RB877-200
A18-516	A72	F4-12	F75	RB14-110F	RB10	2D-8	DD102	14RB-14	RB717
AB14-6A	AB51	F4-14	F71	RB14-111F	RB11	2D10-9	D1D	14RB-14X	RB717-200
AB14-8A	AB52	F4-38	F73	RB14-250	RBB250	2E-6	EE2	14RB-38	RB737
AB14-10A	AB53	F4-516	F72	RB14-250A	RB2577F	2E8-7	E1E	14RB-47PT	RB47PT
AD18-182	AD182	F250TA	FTA250	RB14-250F	RB250	2F-4	FF2	14RB-250F	RB257
AD18-183	AD183	G2-12	G975	RB14-250FP	RB250P	2F6-5	F1F	14RB-250T	RB2517
B14-D	B23	G2-14	G971	RB14-516	RB723	2G21	GG2	14RB-251T	RB25177
B14-4	B132	G2-38	G973	RB14-516X	RB724	2G4-2	G1G	14RB-516	RB727
B14-6	B133	G2-516	G972	RB44	RB4	2RAA	RAA23	14RB-2577	RB2573
B14-6F	B64	H10-14	H971	RBC14-14	RBC713	2RA18	RAA21	14RBC-6	RBC857
B14-6FL	B220	J20-38	J973	RBC14-516	RBC723	2RA18X	RAA217-170	14RBC-8	RBC867
B14-6FS	B19	K30-38	K973	RBD14-182	RBD1823	2RBB	RBB23	14RBC-10	RBC877
B14-8	B86	L40-38	L973	RBD14-183	RBD1833	2RB14	RBB21	14RBC-14	RBC717
B14-8F	B65	M250-38	M973	RC10-6	RC333	2RB14X	RBB217-200	14RBC-516	RBC727
B14-8FL	B223	NW14-6	NW81	RC10-6F	RC1113	2RCC	RCC23	14RBC-38	RBC797
B14-10	B87	NW14-10	NW83	RC10-6FL	RC2203	2RC10	RCC21	14RBC-12	RBC757
B14-10F	B115	NW14-12	NW84	RC10-8	RC863	2RC10X	RCC217-250	14RBD-182	RBD1827
B14-10FL	B225	NW22-10	NW23	RC10-8F	RC1123	2RD8	RDD27	14RBD-183	RBD1837
B14-10G	B87G	RA18D	RA23	RC10-8FL	RC2213	2RE6	REE28	14RBD-18277	RBD18277
B14-12	B75	RA18-4	RA323	RC10-8FS	RC1223	10RC-6	RC337	14RBD-18377	RBD18377
B14-14	B71	RA18-6	RA853	RC10-8X	RC864	10RC-6F	RC1337	18RA-4	RA77
B14-38	B73	RA18-6F	RA1103	RC10-10	RC363	10RC-6FL	RC2207	18RA-6	RA857
B14-110F	B10	RA18-6FL	RA2213	RC10-10F	RC1153	10RC-6FLX	RC2207-250	18RA-6F	RA1167
B14-111F	B11	RA18-6FS	RA1203	RC10-10FL	RC2223	10RC-6X	RC337-250	18RA-6FL	RA2217
B14-250	B250	RA18-8	RA863	RC10-10FS	RC1253	10RC-8	RC777	18RA-6FLX	RA2217-170
B14-250A	B252G	RA18-8F	RA1123	RC10-10X	RC364	10RC-8F	RC1147	18RA-6FX	RA1167-170
B14-250F	B250G	RA18-8FL	RA2243	RC10-12	RC753	10RC-8FL	RC2217	18RA-6X	RA857-170
B14-250T	B251G	RA18-8FS	RA1223	RC10-14	RC713	10RC-8FLX	RC2217-250	18RA-8	RA867
B14-251T	B251	RA18-10	RA873	RC10-14F	RC1163	10RC-8X	RC777-250	18RA-8F	RA1147
B14-516	B72	RA18-10F	RA1153	RC10-14FL	RC2233	10RC-10	RC367	18RA-8FL	RA2247
BC14-6	BC85	RA18-10FL	RA2253	RC10-14X	RC714	10RC-10F	RC1157	18RA-8FX	RA1147-170
BC14-8	BC86	RA18-10FS	RA1253	RC10-38	RC733	10RC-10FL	RC2227	18RA-8X	RA867-170
BC14-10	BC87	RA18-12	RA753	RC10-38X	RC734	10RC-10FLX	RC2227-250	18RA-10	RA877
BC14-12	BC75	RA18-14	RA713	RC10-55PT	RC155PT	10RC-10FX	RC1157-250	18RA-10F	RA1157
BC14-14	BC71	RA18-14F	RA1163	RC10-250A	RC2577F	10RC-10X	RC367-250	18RA-10FL	RA2257
BC14-38	BC79	RA18-38	RA733	RC10-250F	RC250	10RC-14	RC717	18RA-10FLX	RA2257-170
BC14-516	BC72	RA18-47PT	RA147PT	RC10-516	RC703	10RC-14F	RC1167	18RA-14	RA717
BD14-183	BD183	RA18-110F	RA10	RC55	RC6	10RC-14FL	RC2237	18RA-38	RA737
C10-6	C33	RA18-111F	RA11	RD8-10	RD367	10RC-14X	RC717-250	18RA-47PT	RA47PT
C10-6A	C51	RA18-250A	RA2577F	RD8-12	RD757	10RC-38	RC737	18RA-250F	RA257
C10-6F	C133	RA18-250F	RA250	RD8-14	RD717	10RC-38X	RC737-250	18RA-250T	RA2517
C10-6FL	C220	RA18-250FP	RA250P	RD8-38	RD737	10RC-55PT	RC55PT	18RA-251T	RA25177
C10-8	C77	RA18-516	RA723	RD8-516	RD727	10RC-250F	RC257	18RA-516	RA727
C10-8A	C52	RAD18-182	RAD1823	RE6-10	RE267	10RC-250T	RC2517	18RA-516X	RA727-170
C10-8F	C114	RAD18-183	RAD1833	RE6-12	RE757	10RC-251T	RC25177	18RA-2577	RA2573
C10-8FL	C221	RB14-4	RB1323	RE6-14	RE717	10RC-516	RC707	18RAD-182	RAD1827
C10-10	C26	RB14-6	RB853	RE6-38	RE737	10RC-2577	RC2573	18RAD-183	RAD1837
C10-10A	C53	RB14-6F	RB1113	RE6-516	RE727	14RB-4	RB1327	18RAD-18277	RAD18277
C10-10F	C115	RB14-6FL	RB2213	RF4-10	RF267	14RB-6	RB857	18RAD-18377	RAD18377
C10-10FL	C222	RB14-6FS	RB1203	RF4-12	RF757				
C10-12	C75	RB14-6X	RB854	RF4-14	RF717				

Sta-Kon Terminal Products and Tools

United States
Tel: 901.252.8000
800.816.7809
Fax: 901.252.1354

Technical Services
Tel: 888.862.3289

Thomas & Betts

www.tnb.com

Cross Reference for Packaging

CAT. NO. T&B DISTRIBUTOR PACKAGE	CAT. NO. T&B BULK PACKAGE	CAT. NO. T&B DISTRIBUTOR PACKAGE	CAT. NO. T&B BULK PACKAGE	CAT. NO. T&B DISTRIBUTOR PACKAGE	CAT. NO. T&B BULK PACKAGE	CAT. NO. T&B DISTRIBUTOR PACKAGE	CAT. NO. T&B BULK PACKAGE	CAT. NO. T&B DISTRIBUTOR PACKAGE	CAT. NO. T&B BULK PACKAGE
RB14-8	RB863	RC10-14	RC713	A18-110F	A10	C1010F	C115	18RA-8X	RA867-170
RB14-8X	RB864	RC10-14X	RC714	A18-111F	A11	C10-14F	C116	RA18-10	RA873
14RB-8	RB867	10RC-14	RC717	A18-10F	A115	C10-6F	C133	18RA-10	RA877
14RB-8X	RB867-200	10RC-14X	RC717-250	A18-14	A71	C10-6FL	C220	18RA-10X	RA877-170
RB14-10	RB873	RC10-38	RC733	A18-14F	A71F	C10-8FL	C221	RA18-6F	RA1103
RB14-10X	RB874	RC10-38X	RC734	A18-12	A75	C10-10FL	C222	RA18-8F	RA1123
14RB-10	RB877	10RC-38	RC737	A18-6	A85	C10-250F	C250	18RA-8F	RA1147
14RB-10X	RB877-200	10RC-38X	RC737-250	A18-8	A86	C10-250A	C252G	18RA-8FX	RA1147-170
RB14-6F	RB1113	RC10-12	RC753	A18-10	A87	2C14-12	C1C	RA18-10F	RA1153
RB14-8F	RB1123	10RC-8	RC777	A18-8F	A114	2C10	CC2	18RA-10F	RA1157
RB14-10F	RB1153	10RC-8X	RC777-250	A18-10F	A115	D8-10	D36	RA18-14F	RA1163
14RB-10F	RB1157	10RC-8	RC863	A18-6F	A116	D8-14	D71	18RA-6F	RA1167
14RB-10FX	RB1157-200	RC10-8X	RC864	A18-6FL	A221	D8-516	D72	18RA-6FX	RA1167-170
RB14-14F	RB1163	RC10-6F	RC1113	A18-8FL	A224	D8-38	D73	RA18-6FS	RA1203
RB14-6FS	RB1203	RC10-8F	RC1123	A18-10FL	A225	D8-12	D75	RA18-8FS	RA1223
RB14-8FS	RB1223	10RC-8F	RC1147	A18-250	A250	2D10-9	D1D	RA18-10FS	RA1253
RB14-10FS	RB1253	RC10-10F	RC1153	A18-251T	A251	2D8	DD102	RA18-6FL	RA2213
RB14-4	RB1323	10RC-10F	RC1157	A18-250A	A252G	E6-10	E26	18RA-6FL	RA2217
14RB-4	RB1327	10RC-10FX	RC1157-250	2A22-20	A1A	E6-14	E71	18RA-6FLX	RA2217-170
14RB-6FL	RB2207	RC10-14F	RC1163	2A18	AA2	E6-516	E72	RA18-8FL	RA2243
14RB-6FLX	RB2207-200	RC10-8FS	RC1223	AB14-6A	AB51	E6-38	E73	18RA-8FL	RA2247
RB14-6FL	RB2213	RC10-10FS	RC1253	AB14-8A	AB52	E6-12	E75	RA18-10FL	RA2253
RB14-8FL	RB2233	10RC-6F	RC1337	AB14-10A	AB53	2E8-7	E1E	18RA-10FL	RA2257
14RB-8FL	RB2237	RC10-6FL	RC2203	AD18-182	AD182	2.00E+06	EE2	18RA-10FLX	RA2257-170
14RB-8FLX	RB2237-200	10RC-6FL	RC2207	AD18-183	AD183	F4-10	F26	18RA-250T	RA2517
RB14-10FL	RB2253	10RC-6FLX	RC2207-250	B14-110F	B10	F4-14	F71	18RA-2577	RA2573
14RB-10FL	RB2257	RC10-8FL	RC2213	B14-111F	B11	F4-516	F72	RA18-250A	RA2577F
14RB-10FLX	RB2257-200	10RC-8FL	RC2217	B14-D	B23	F4-38	F73	18RA-251T	RA25177
14RB-250T	RB2517	10RC-8FLX	RC2217-250	B14-6F	B64	F4-12	F75	2RA18	RAA21
14RB-2577	RB2573	RC10-10FL	RC2223	B14-8F	B65	2F6-5	F1F	2RAA	RAA23
RB14-250A	RB2577F	10RC-10FL	RC2227	B14-14	B71	2F4	FF2	2A20	RAA24
14RB-251T	RB25177	10RC-10FLX	RC2227-250	B14-516	B72	F250-TA	FTA250	2RA18X	RAA217-170
2RB14	RBB21	RC10-14FL	RC2233	B14-38	B73	G2-14	G971	RAD18-182	RAD1823
2RBB	RBB23	10RC-14FL	RC2237	B14-12	B75	G2-516	G972	18RAD-182	RAD1827
2B16	RBB25	10RC-250T	RC2517	B14-6	B133	G2-38	G973	RAD18-183	RAD1833
2RB14X	RBB217-200	10RC-2577	RC2573	B14-8	B86	G2-12	G975	18RAD-183	RAD1837
RB14-250	RBB250	RC10-250A	RC2577F	B14-10	B87	2G4-2	G1G	RAD18-188A	RAD1887F
RBC14-14	RBC713	10RC-251T	RC25177	B14-10G	B87G	2G21	GG2	18RAD18277	RAD18277
14RBC-14	RBC717	2RC10	RCC21	B14-10F	B115	H10-14	H971	18RAD18377	RAD18377
RBC14-516	RBC723	2RCC	RCC23	B14-4	B132	J20-38	J973	RB44	RB4
14RBC-516	RBC727	2C12	RCC26	B14-6FL	B220	K30-38	K973	RB14-110F	RB10
14RBC-12	RBC757	2RC10X	RCC217-250	B14-8FL	B223	L40-38	L973	RB14-111F	RB11
14RBC-38	RBC797	RD8-10	RD367	B14-10FL	B225	M250-38	M973	RB14-D	RB23
14RBC-6	RBC857	RD8-14	RD717	B14-250	B250	NW22-10	NW23	14RB-47PT	RB47PT
14RBC-8	RBC867	RD8-516	RD727	B14-250F	B250G	NW14-10	NW83	14RB-6FS	RB197
14RBC-10	RBC877	RD8-38	RD737	B14-251T	B251	NW14-12	NW84	RB14-47PT	RB147PT
RBD14-182	RBD1823	RD8-12	RD757	B14-250T	B251G	RA18-110F	RA10	RB14-250F	RB250
14RBD-182	RBD1827	2RD8	RDD27	B14-250A	B252G	RA18-111F	RA11	RB14-250FP	RB250P
RBD14-183	RBD1833	RE6-10	RE267	2B18-16	B1B	RA18-D	RA23	14RB-250F	RB257
14RBD-183	RBD1837	RE6-14	RE717	2B14	BB2	18RA-47PT	RA47PT	14RB-6F	RB647
14RBD-18277	RBD18277	RE6-516	RE727	BC14-14	BC71	18RA-4	RA77	14RB-6FX	RB647-200
14RBD-18377	RBD18377	RE6-38	RE737	BC14-516	BC72	RA18-47PT	RA147PT	14RB-8F	RB657
RC55	RC6	RE6-12	RE757	BC14-12	BC75	RA18-250F	RA250	14RB-8FX	RB657-200
10RC-55PT	RC55PT	2RE6	REE28	BC14-38	BC79	RA18-250FP	RA250P	RB14-14	RB713
RC10-55PT	RC155PT	RF4-10	RF267	BC14-6	BC85	18RA-250F	RA257	RB14-14X	RB714
RC10-250F	RC250	RF4-14	RF717	BC14-8	BC86	RA18-4	RA323	14RB-14	RB717
10RC-250F	RC257	RF4-516	RF727	BC14-10	BC87	RA18-14	RA713	14RB-14X	RB717-200
RC10-6	RC333	RF4-38	RF737	BD14-183	BD183	18RA-14	RA717	RB14-516	RB723
10RC-6	RC337	2RF4	RFF29	C10-10	C26	RA18-516	RA723	RB14-516X	RB724
10RC-6X	RC337-250	RG2-10	RG267	C10-6	C33	18RA-516	RA727	14RB-516	RB727
RC10-10	RC363	RG2-14	RG717	C10-8A	C52	RA18-38	RA733	RB14-38	RB733
RC10-10X	RC364	RG2-516	RG727	C10-10	C53	18RA-38	RA737	RB14-38X	RB734
10RC-10	RC367	RG2-38	RG737	C10-516	AC70	RA18-12	RA753	14RB-38	RB737
10RC-10X	RC367-250	RG2-12	RG757	C10-14	C71	RA18-6	RA853	RB14-12	RB753
RC10-516	RC703	RP12	RP7	C10-38	C73	18RA-6	RA857	RB14-6	RB853
10RC-516	RC707			C10-12	C75	18RA-6X	RA857-170	RB14-6X	RB854
				C10-8	C77	RA18-8	RA863	14RB-6	RB857
				C10-8F	C114	18RA-8	RA867	14RB-6X	RB857-200

Catamount® Terminals



Vinyl Insulated Ring Terminals



CAT. NO.	WIRE RANGE	BOLT SIZE	PKG. QTY.
TV18-6R	22-16	#6	50
TV18-8R		#8	50
TV18-10R		#10	50
TV18-14R		¼"	50
TV18-516R		⅝"	50
TV14-6R	16-14	#6	50
TV14-8R		#8	50
TV14-10R		#10	50
TV14-14R		¼"	50
TV14-516R		⅝"	50
TV14-38R	¾"	50	
TV10-6R	12-10	#6	25
TV10-8R		#8	25
TV10-10R		#10	25
TV10-14R		¼"	25
TV10-516R		⅝"	25
TV10-38R	¾"	25	
TV10-12R	½"	25	
TV8-8R	8 AWG	#8	10
TV8-10R		#10	10
TV8-14R		¼"	10
TV8-516R		⅝"	10
TV8-38R		¾"	10
TV8-12R	½"	10	
TV6-10R	6 AWG	#10	10
TV6-14R		¼"	10
TV6-516R		⅝"	10
TV6-38R		¾"	10
TV6-12R		½"	10

*8 AWG 25 to a package **6 AWG 10 to a package



Non-Insulated Ring Terminals



CAT. NO.	WIRE RANGE	BOLT SIZE	PKG. QTY.
T18-6R	22-16	#4-#6	50
T18-8R		#8	50
T18-10R		#10	50
T14-6R	16-14	#6	50
T14-8R		#8	50
T14-10R		#10	50
T10-6R	12-10	#6	25
T10-8R		#8	25
T10-10R		#10	25
T10-14R		¼"	25



Vinyl Insulated Fork Terminals



CAT. NO.	WIRE RANGE	BOLT SIZE	PKG. QTY.
TV18-6F	22-16	#6	50
TV18-8F		#8	50
TV18-10F		#10	50
TV18-14F		¼"	50
TV14-6F	16-14	#6	50
TV14-8F		#8	50
TV14-10F		#10	50
TV14-14F		¼"	50
TV10-6F	12-10	#6	25
TV10-8F		#8	25
TV10-10F		#10	25
TV10-14F		¼"	25
TV10-516F		⅝"	25



Non-Insulated Fork Terminals

CAT. NO.	WIRE RANGE	BOLT SIZE	PKG. QTY.
T18-6F	22-16	#6	50
T18-8F		#8	50
T18-10F		#10	50
T14-6F	16-14	#6	50
T14-8F		#8	50
T14-10F		#10	50
T10-6F	12-10	#6	25
T10-8F		#8	25
T10-10F		#10	25
T10-14F		¼"	25



Vinyl Insulated Locking Fork Terminals



CAT. NO.	WIRE RANGE	BOLT SIZE	PKG. QTY.
TV18-6LF	22-16	#6	50
TV18-8LF		#8	50
TV18-10LF		#10	50
TV14-6LF	16-14	#6	50
TV14-8LF		#8	50
TV14-10LF		#10	50
TV10-6LF	12-10	#6	25
TV10-8LF		#8	25
TV10-10LF		#10	25



Non-Insulated Locking Fork Terminals



CAT. NO.	WIRE RANGE	BOLT SIZE	PKG. QTY.
T18-6LF	22-16	#6	50
T18-8LF		#8	50
T18-10LF		#10	50
T14-6LF	16-14	#6	50
T14-8LF		#8	50
T14-10LF		#10	50
T10-6LF	12-10	#6	25
T10-8LF		#8	25
T10-10LF		#10	25



Vinyl Insulated Butt Splices



CAT. NO.	WIRE RANGE	PKG. QTY.
TV18-BS	22-18	50
TV14-BS	16-14	50
TV10-BS	12-10	25



Nylon Wire Joints



CAT. NO.	WIRE RANGE	STD. PKG. QTY.
TN18-WJ	22-16	50
TN14-WJ	16-14	50
TN10-WJ	12-10	25

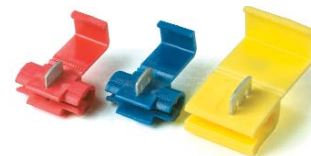

Multiple Quick Splices

CAT. NO.	WIRE RANGE	PKG. QTY.
TV18-00QS	22-16	50
TV14-00QS	16-14	50
TV10-00QS	12-10	25

United States
Tel: 901.252.8000
800.816.7809
Fax: 901.252.1354

Technical Services
Tel: 888.862.3289

Thomas & Betts

www.tnb.com

Catamount® Terminals



Vinyl Insulated Female Disconnects — 250 Series



CAT. NO.	WIRE RANGE	PKG. QTY.
TV18-250FD	22-16	50
TV14-250FD	16-14	50
TV10-250FD	12-10	25



Nylon Fully Insulated Female Disconnects — 250 Series



CAT. NO.	WIRE RANGE	PKG. QTY.
TNF18-250FD	22-16	50
TNF14-250FD	16-14	50
TNF10-250FD	12-10	25



Vinyl Fully Insulated Female Disconnects — 250 Series



CAT. NO.	WIRE RANGE	PKG. QTY.
TVF18-250FD	22-16	50
TVF14-250FD	16-14	50
TVF10-250FD	12-10	25



Vinyl Insulated Male Disconnects — 250 Series



CAT. NO.	WIRE RANGE	PKG. QTY.
TV18-250MD	22-16	50
TV14-250MD	16-14	50
TV10-250MD	12-10	25



Nylon Fully Insulated Male Disconnects — 250 Series



CAT. NO.	WIRE RANGE	PKG. QTY.
TNF18-250MD	22-16	50
TNF14-250MD	16-14	50
TNF10-250MD	12-10	25



Vinyl Insulated Piggyback Disconnects — 250 Series



CAT. NO.	WIRE RANGE	PKG. QTY.
TV18-250PD	22-16	50
TV14-250PD	16-14	50
TV10-250PD	12-10	25



Vinyl Fully Insulated Female Bullet Connectors — 4mm (.156")



CAT. NO.	WIRE RANGE	PKG. QTY.
TVF18-4FB	22-16	50



Nylon Fully Insulated Female Bullet Connectors



CAT. NO.	WIRE RANGE	PKG. QTY.
TNF18-4FB	22-16	50
TNF14-4FB	16-14	50



Vinyl Insulated Straight Blade Terminals



CAT. NO.	WIRE RANGE	PKG. QTY.
TV18-10BL	22-16	50
TV18-18BL		50
TV14-10BL	16-14	50
TV14-18BL		50
TV10-10BL	12-10	25



Vinyl Insulated Male Bullet Connectors — 4mm (.156")



CAT. NO.	WIRE RANGE	PKG. QTY.
TV18-4MB	22-16	50
TV14-4MB	16-14	50



Fully Insulated Nylon Male Bullet Connectors



CAT. NO.	WIRE RANGE	PKG. QTY.
TNF18-4MB	22-16	50
TNF14-4MB	16-14	50



Vinyl Insulated Straight Pin Terminals



CAT. NO.	WIRE RANGE	PKG. QTY.
TV18-12PT	22-16	50
TV14-12PT	16-14	50
TV10-14PT	12-10	25



Sta-Kon® Terminal Products and Tools



WT111M



WT112M



ERG1-WS



CM2000A



TBM6S

CAT. NO.	DESCRIPTION	PKG. QTY.
WT111M	Plier tool with cutter for 22–10 AWG non-insulated terminals	1
WT112M	Plier tool with cutter for 22–10 AWG insulated and non-insulated terminals, splices and disconnects	1
TBM6S	Toggle Type Hand Tool with Shure-Stake® for 8–6 AWG, vinyl insulated terminals (dies sold separately)	1
ERG1-WS	Ergonomic Wire Stripping Tool	1
CM2000A	10" Ratchet Crimping Tool for insulated terminals (22–10 AWG)	1

United States
Tel: 901.252.8000
800.816.7809
Fax: 901.252.1354

Technical Services
Tel: 888.862.3289

Thomas & Betts
www.tnb.com

Platings/Finish

Electroplated-Tin is standard finish. All others require minimum order quantities and are generally not stocked. Alternative platings are as follows: Gold, Silver, Tin-Alloys, Nickel or plain finish. See table (**below**) for specification information:

FINISH	SUFFIX	SPEC.	TEMP. RATING
Gold Plate	GP	MIL-G-45204 Type II, Grade B, C, D, Class O	260° C
Nickel Plate	NP	QQ-N-290 Class 2, Grade G	260° C
Plain Finish	PF	None	150° C
Silver Plate	SP	MIL-T-16366 Type I or II, 400° F, 204° C	150° C

Listing

Sta-Kon® Rings, Forks and Locking Forks are tested and listed to UL® 486A, two-way splices to UL 486C, disconnects to UL 310, and all applicable products to CSA 22.2.



Sta-Kon® Technical Data

TERMINALS & SPLICES INSULATION RATING	UL® 94 FLAMMABILITY	VOLTAGE	TEMPERATURE
Nylon	V-2	600V**	105° C
Vinyl	V-0	600V**	105° C
Tefzel®	V-0	600V**	150° C
Disconnects		300V	105° C
Non-Insulated	—	600V	150° C

**1000V fixture or sign

The proper installation procedure for the quality assured connection!

The proper installation of terminals, splices, and connectors is very important to the efficient performance of an electrical system. The properly installed connector will enable good conductivity through the termination. A poor termination results in a high-resistance connection. A poor connector installation may cause damage or failure of an entire system. Certain basic requirements must be met to make a good termination.

Before the connector or terminal is installed on the conductor, follow these recommended practices:

- Strip the insulation carefully to avoid nicking or cutting conductor strands
- Strip the insulation to the proper length so the conductors can be inserted fully into the connector barrel; the wire/cable should be visible in the inspection hole of the lug; the proper strip length can be found on page F-45.

Installation Procedure

1. Train the wires to eliminate fanning of strands.
2. Open handles fully.
3. Insert terminal in proper die nest and locate it as shown above. When crimping a butt splice, position in proper die nest with window facing indenter.
4. Close handles slightly to secure terminal. Do not deform terminal.
5. Insert properly stripped wire into terminal.
6. Complete crimp by closing handles.

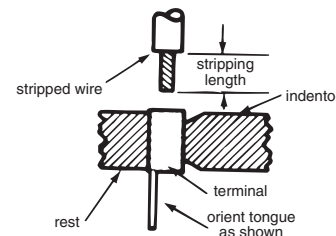

Shure-Stake® tools are matched to terminals.