

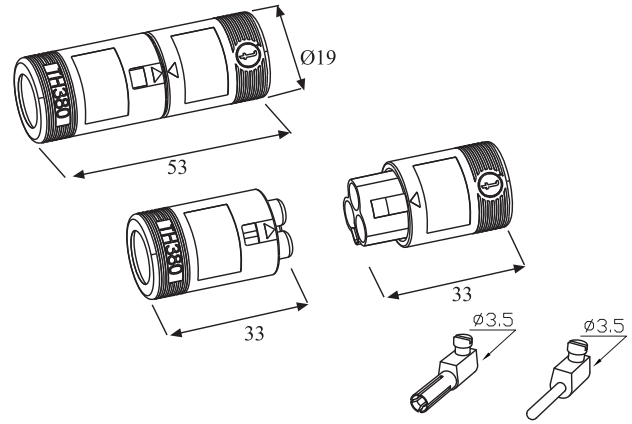

TH380

PATENTED IP20

2 -3 Poli



Connessione presa- spina 2-3 poli senza fissacavi, per uso interno.
Facilità di cablaggio .Connessione a bussola o pin a crimpare oppure ibrida pin/bussola . Grado di protezione IP 20. Aggancio a clip.

2-3 poles plug-socket connection without cable clamp, indoor only.
Easy wiring. Pin crimp or bush connection, or hybrid pin crimp/bush.
IP20 protection.Clip clamping.

Dati tecnici - Technical data

25 A	2,5 ^o	IP20
400V	T 85 ° C	PTI175

Rated current **25 A**
Impulse withstand voltage **6 KV**
Range of temperature **0 - 85°C**
Cable max **3G 2,5^o H07RN-F**
Proof tracking index **PTI175**

Materie prime - Raw materials

Materia plastica - Plastics

PA66 UL94 V2 GWT 850°C

	Nero - Black	} -20°C
	Grigio - Grey RAL 7035	
		+125°C

Bussole- Insert

M3 Acciaio zincato passivato
Zinc plated steel

} Ottone nichelato
Nickel plated brass
 } **AG=** Ottone Argentato
Silver plated brass

Pin - Crimp

> Solo parte plastica - Plastic part only

> Per pin cilindrici universali Ø 2

Norme - Standards

EN 61984-2001

Vedi TH023-See TH023



Codice - Part number

T H B . 3 8 0 . X X X

2 poli poles

frutti intercambiabili - interchangeable modules



PLUG

THB.380.A2A
THB.380.A2C
THB.380.A2A.AG
THB.380.A2C.AG

Nero - Black
Grigio - Grey
RAL 7035
Nero - Black
Grigio - Grey
RAL 7035



POWER-SOCKET

THB.380.B2A
THB.380.B2C
THB.380.B2A.AG
THB.380.B2C.AG

Nero - Black
Grigio - Grey
RAL 7035
Nero - Black
Grigio - Grey
RAL 7035



3 poli poles



PLUG

THB.380.A1A
THB.380.A1C
THB.380.A1A.AG
THB.380.A1C.AG

Nero - Black
Grigio - Grey
RAL 7035
Nero - Black
Grigio - Grey
RAL 7035



POWER-SOCKET

THB.380.B1A
THB.380.B1C
THB.380.B1A.AG
THB.380.B1C.AG

Nero - Black
Grigio - Grey
RAL 7035
Nero - Black
Grigio - Grey
RAL 7035



Eventuali modifiche e migliorie sui dati tecnici o sul prodotto potranno essere effettuate senza preavviso.
All technical data or other eventual product modifications and improvements can be carried out without notice

Codice - Part number

THF.380.XXX

2 poli
poles

3 poli
poles



THF.380.A2A Nero - Black
THF.380.A2C Grigio - Grey
RAL 7035

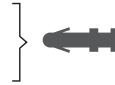

THF.380.A1A Nero - Black
THF.380.A1C Grigio - Grey
RAL 7035



THF.380.B2A Nero - Black
THF.380.B2C Grigio - Grey
RAL 7035

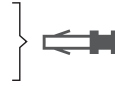

THF.380.B1A Nero - Black
THF.380.B1C Grigio - Grey
RAL 7035



PLUG

PLUG

POWER-SOCKET

POWER-SOCKET

Kit di fornitura non assemblato THB-F
Unassembled kit THB-F

Kit di fornitura assemblato THZ
Assembled kit THZ

THX.380.AXX.XX

THX.023.XXX.XX

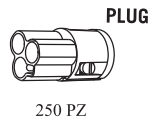
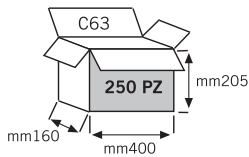

6000158CC
6000158CE

250 PZ

250 PZ

THX.380.BXX.XX

THX.023.XXX.XX

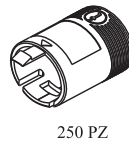
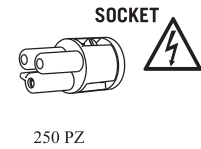
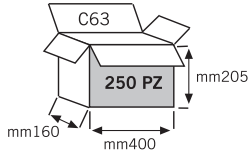

6000159CC
6000159CE

250 PZ

250 PZ

THZ.380.XXX.XX

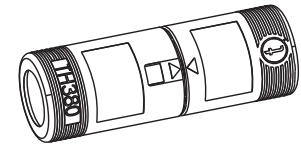
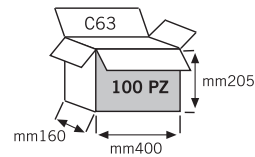

100 PZ

Kit di fornitura imbustati THR
Retail packed kit THR
Please refer to THR Retail Catalogue

Kit di fornitura con versionamenti e confezionamenti speciali THK
Special custom packed version THK

THR.380.SXX.XX

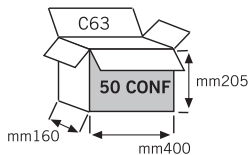

1 CONF
1 PZ

THK.380.XXX

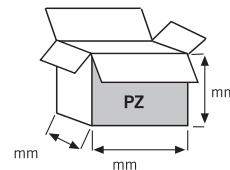

Possibilità di abbinamento tra TH380 e TH382
Match possibility between TH380 and TH382



Vedi istruzioni di assemblaggio
Refer to user instructions

