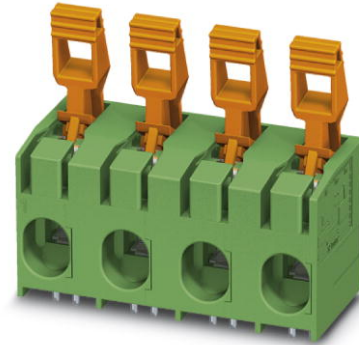

**PLH 16/ 3-15**

Order No.: 1770542

<http://eshop.phoenixcontact.net/phoenix/treeViewClick.do?UID=1770542>

PC terminal block, Nom. voltage: 1000 V, Pitch: 15 mm, Number of positions: 3, Type of connection: Spring-cage conn., Assembly: Soldering, Conductor/PCB connection direction: 0 °, Color: green

**Commercial data**

EAN	4046356457743
Pack	50 pcs.
Customs tariff	85369010
Weight/Piece	0.02691 KG
Catalog page information	Page 343 (CC-2009)

**Product notes**

WEEE/RoHS-compliant since:  
10/02/2008



<http://www.download.phoenixcontact.com>  
Please note that the data given here has been taken from the online catalog. For comprehensive information and data, please refer to the user documentation. The General Terms and Conditions of Use apply to Internet downloads.

**Technical data****Dimensions / positions**

Pitch	15 mm
Dimension a	30 mm
Number of positions	3
Pin dimensions	1,2 x 1,2 mm

Pin spacing	15 mm
Hole diameter	1.6 mm

**Technical data**

Insulating material group	I
Rated surge voltage (III/3)	8 kV
Rated surge voltage (III/2)	8 kV
Rated surge voltage (II/2)	8 kV
Rated voltage (III/2)	1000 V
Rated voltage (II/2)	1000 V
Nominal voltage $U_N$	1000 V
Nominal cross section	16 mm <sup>2</sup>
Insulating material	PA
Inflammability class acc. to UL 94	V0
Stripping length	18 mm

**Connection data**

Conductor cross section solid min.	0.75 mm <sup>2</sup>
Conductor cross section solid max.	16 mm <sup>2</sup>
Conductor cross section stranded min.	0.75 mm <sup>2</sup>
Conductor cross section stranded max.	16 mm <sup>2</sup>
Conductor cross section stranded, with ferrule without plastic sleeve min.	0.75 mm <sup>2</sup>
Conductor cross section stranded, with ferrule without plastic sleeve max.	16 mm <sup>2</sup>
Conductor cross section stranded, with ferrule with plastic sleeve min.	0.75 mm <sup>2</sup>
Conductor cross section stranded, with ferrule with plastic sleeve max.	10 mm <sup>2</sup>
Conductor cross section AWG/kcmil min.	18
Conductor cross section AWG/kcmil max	4
2 conductors with same cross section, stranded, TWIN ferrules with plastic sleeve, min.	0.75 mm <sup>2</sup>
2 conductors with same cross section, stranded, TWIN ferrules with plastic sleeve, max.	4 mm <sup>2</sup>

Diagrams/Drawings

Drilling plan/solder pad geometry

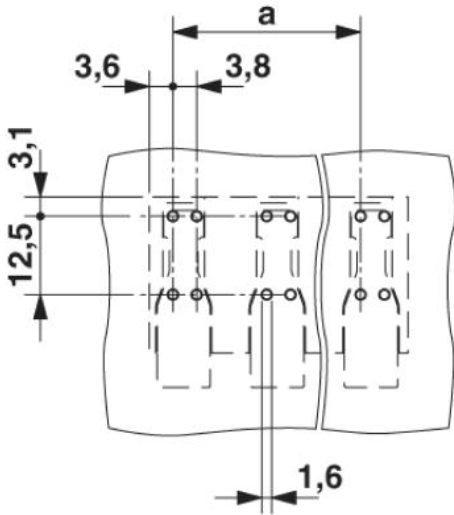

Functional drawing

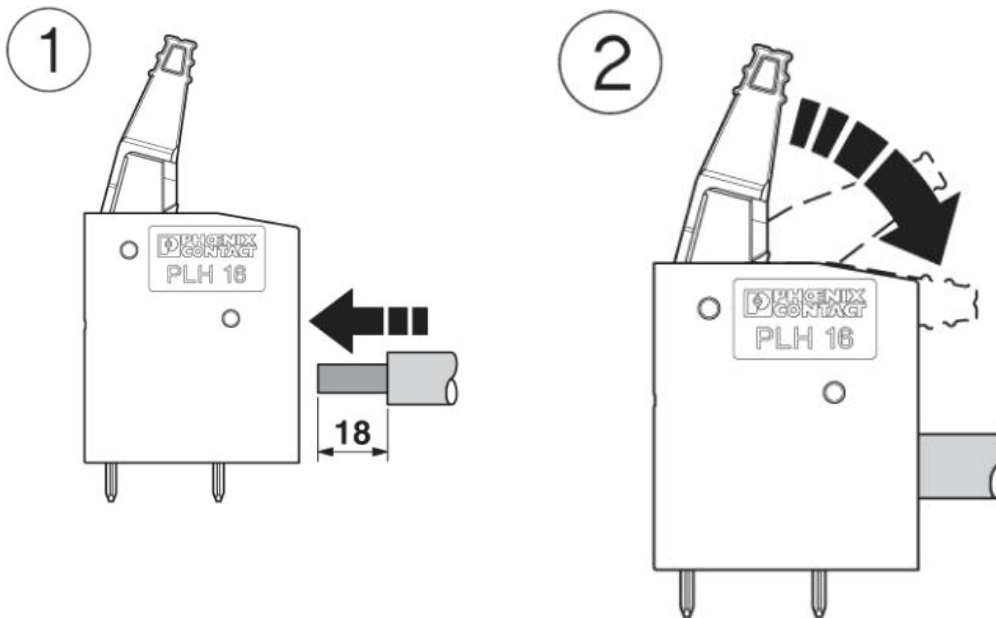

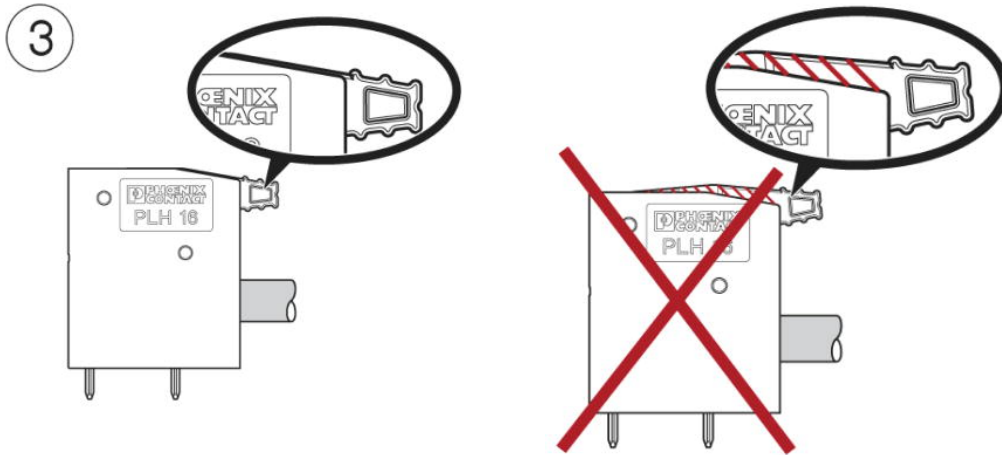

Dimensioned drawing

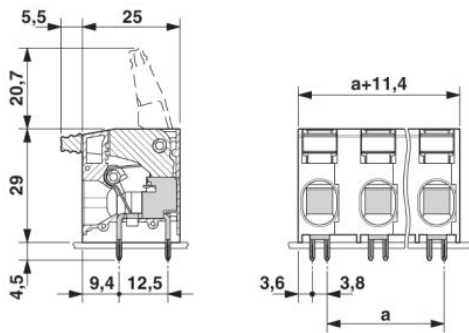

**Address**

PHOENIX CONTACT GmbH & Co. KG  
Flachsmarktstr. 8  
32825 Blomberg, Germany  
Phone +49 5235 3 00  
Fax +49 5235 3 41200  
<http://www.phoenixcontact.com>



© 2010 Phoenix Contact  
Technical modifications reserved;