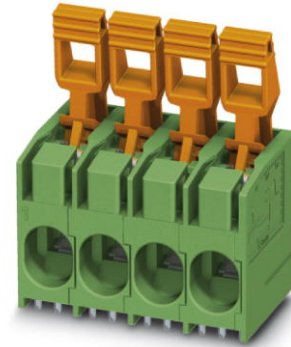

PLH 16/ 3-10-ZF

Order No.: 1770474

<http://eshop.phoenixcontact.net/phoenix/treeViewClick.do?UID=1770474>

PC terminal block, Nom. voltage: 1000 V, Pitch: 10 mm, Number of positions: 3, Type of connection: Spring-cage conn., Assembly: Soldering, Conductor/PCB connection direction: 0 °, Color: green

Commercial data

EAN	4046356458214
Pack	50 pcs.
Customs tariff	85369010
Weight/Piece	0.02151 KG
Catalog page information	Page 343 (CC-2009)

Product notes

WEEE/RoHS-compliant since:
10/02/2008



<http://www.download.phoenixcontact.com>
Please note that the data given here has been taken from the online catalog. For comprehensive information and data, please refer to the user documentation. The General Terms and Conditions of Use apply to Internet downloads.

Technical data**Dimensions / positions**

Pitch	10 mm
Dimension a	20 mm
Number of positions	3
Pin dimensions	1,2 x 1,2 mm

Pin spacing	10 mm
Hole diameter	1.6 mm

Technical data

Insulating material group	I
Rated surge voltage (III/3)	8 kV
Rated surge voltage (III/2)	8 kV
Rated surge voltage (II/2)	8 kV
Rated voltage (III/2)	1000 V
Rated voltage (II/2)	1000 V
Nominal voltage U_N	1000 V
Nominal cross section	16 mm ²
Insulating material	PA
Inflammability class acc. to UL 94	V0
Stripping length	18 mm

Connection data

Conductor cross section solid min.	0.75 mm ²
Conductor cross section solid max.	16 mm ²
Conductor cross section stranded min.	0.75 mm ²
Conductor cross section stranded max.	16 mm ²
Conductor cross section stranded, with ferrule without plastic sleeve min.	0.75 mm ²
Conductor cross section stranded, with ferrule without plastic sleeve max.	16 mm ²
Conductor cross section stranded, with ferrule with plastic sleeve min.	0.75 mm ²
Conductor cross section stranded, with ferrule with plastic sleeve max.	10 mm ²
Conductor cross section AWG/kcmil min.	18
Conductor cross section AWG/kcmil max	4
2 conductors with same cross section, stranded, TWIN ferrules with plastic sleeve, min.	0.75 mm ²
2 conductors with same cross section, stranded, TWIN ferrules with plastic sleeve, max.	4 mm ²

Diagrams/Drawings

Drilling plan/solder pad geometry

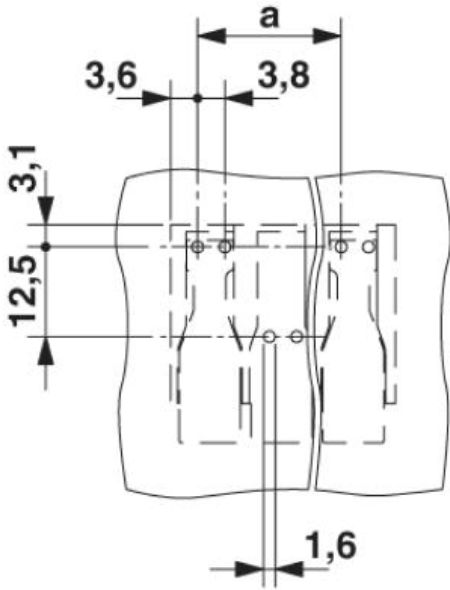

Diagram

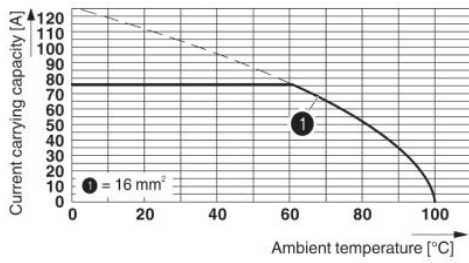

Type: PLH 16/...-10-ZF

Test based on DIN EN 60512-5-2:2003-01

Number of positions: 3

Conductor cross-section: 16 mm² (only for solid conductors)

Functional drawing

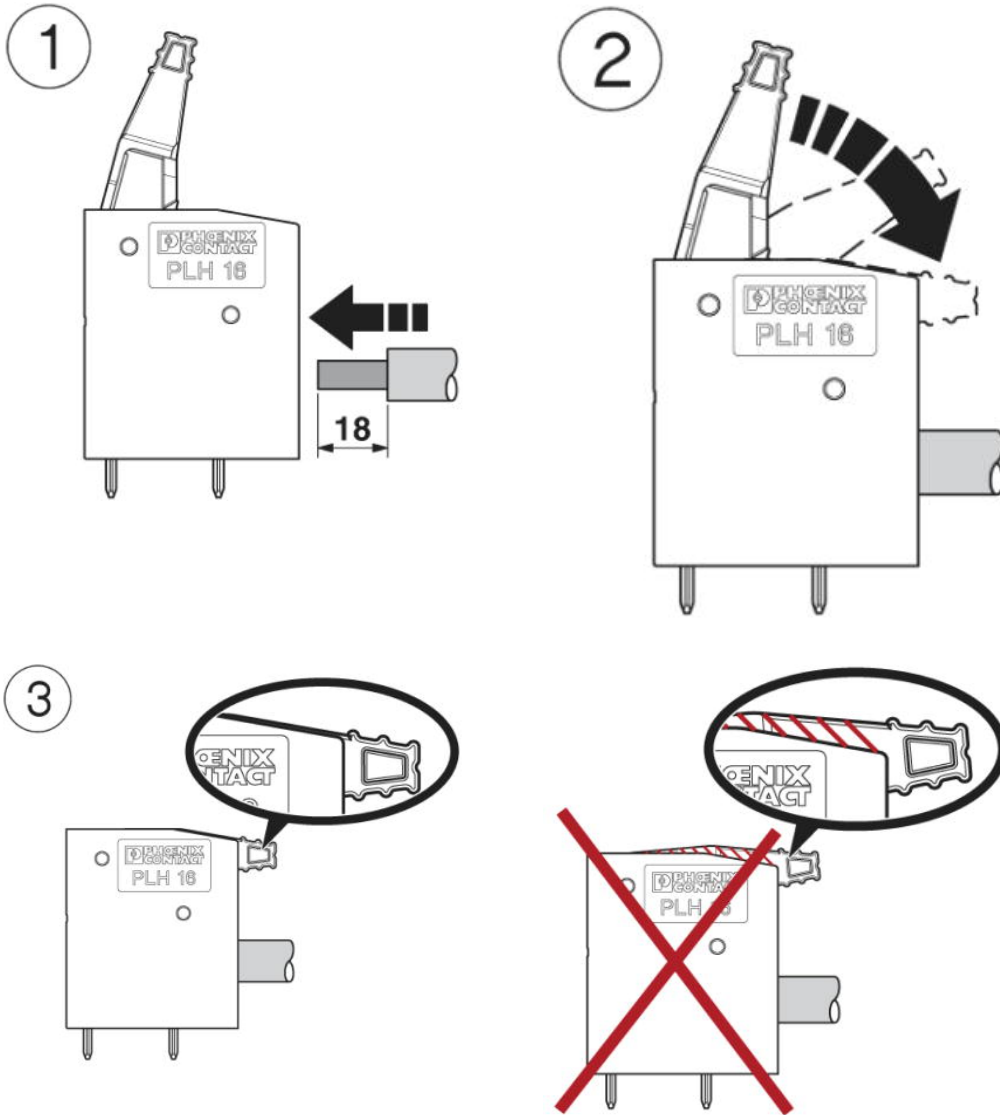

Dimensioned drawing

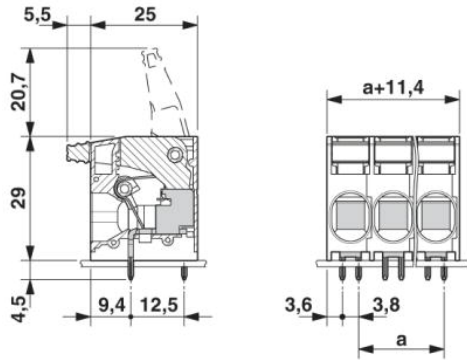

Address

PHOENIX CONTACT GmbH & Co. KG
Flachsmarktstr. 8
32825 Blomberg, Germany
Phone +49 5235 3 00
Fax +49 5235 3 41200
<http://www.phoenixcontact.com>



© 2010 Phoenix Contact
Technical modifications reserved;