



GDSN 307 schwarz/black

Industrial Connectors:Rectangular connectors GDM-series:Type CEN 175301-803 (DIN 43650):Cable socket

Product description

Description	cable socket with central screw M 2.5 x 27
Type	GDSN 307 schwarz/black
Order No.	933 023-100
Other standard types	grey housing, Order No. 933 023-106
Number of contacts	3 + PE
Cable gland	PG 7
Conductor size	max. 0.75 mm ²
Standard	DIN EN 175 301-803-C
Housing Color	black
Construction type	C

Drawing

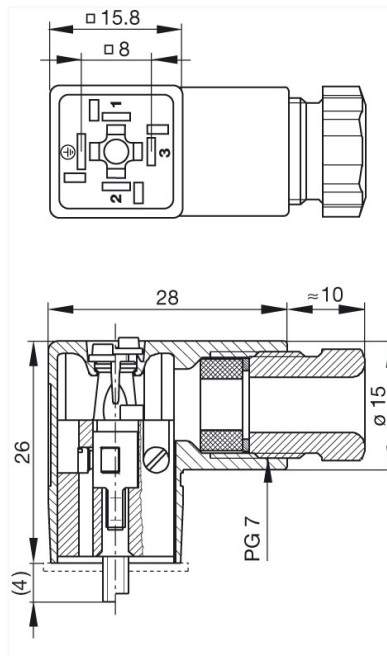

Technical data

Pin dimensions	2,8 mm x 0,5 mm, 3,6 mm x 0,5 mm
Rated voltage	AC/DC 250 V
Rated current	6 A
Contact resistance	<= 4 mOhm
Type of termination	screw
Suitable cables	4.5 mm to 6 mm

Mounting	central screw
Material	
Contact surface material	Sn
Contact bearer material	PA
Housing material	PA
Environmental conditions	
Protection class (IEC 60529)	IP 65
Pollution severity	3
Temperature range	-40 °C to +125 °C
Inflammability class	
Housing	94 HB
Contact bearer	94 V-2
Approvals	
UR	UR
VDE	VDE
SEV	SEV
CSA	CSA
Packing unit	
Packaging unit	200 pieces
Scope of delivery and accessories	
Accessories to order separately	(NBR) flat gasket GDSN 307-4, Order No. 730 176-002; (EPDM) flat gasket GDSN 307-5, Order No. 730 310-004