



PART NO.

13-04-19 TSS URM70

REVISIONS

ECN #	REV	DESCRIPTION	DRAWN	DATE	CHECKD	DATE	APPRVD	DATE
-	A	RELEASED	Kavitha	31/8/07	Suresh	31/8/07	G. C	17/9/07

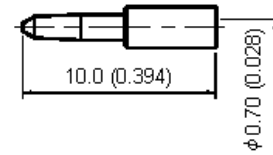
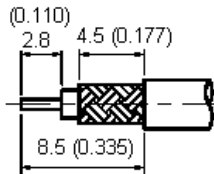
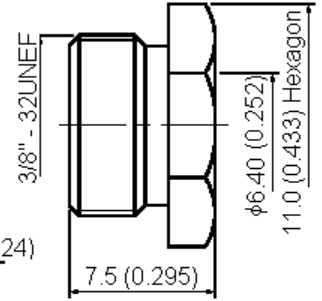
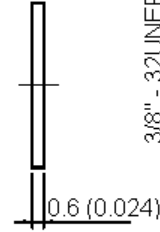
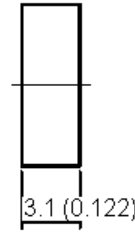
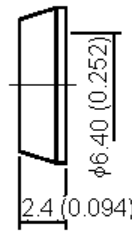
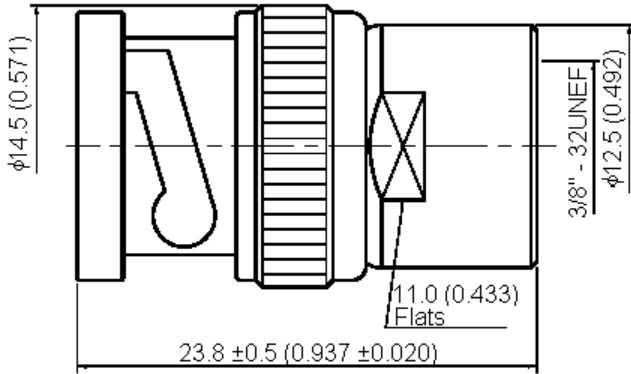

Stripping Dimension

Dimensions : Millimetres (Inches)

Specifications:

- Bodies : Brass per JIS-C3604.
- Centre Contact : Brass per JIS-C3604.
- Insulation : Teflon per ASTM D1457 and ASTM D1710.
- Part to be clean and free of burrs.

This data sheet and its contents (the "Information") belong to the Premier Farnell Group (the "Group") or are licensed to it. No licence is granted for the use of it other than for information purposes in connection with the products to which it relates. No licence of any intellectual property rights is granted. The Information is subject to change without notice and replaces all data sheets previously supplied. The Information supplied is believed to be accurate but the Group assumes no responsibility for its accuracy or completeness, any error in or omission from it or for any use made of it. Users of this data sheet should check for themselves the Information and the suitability of the products for their purpose and not make any assumptions based on information included or omitted. Liability for loss or damage resulting from any reliance on the Information or use of it (including liability resulting from negligence or where the Group was aware of the possibility of such loss or damage arising) is excluded. This will not operate to limit or restrict the Group's liability for death or personal injury resulting from its negligence. SPC MULTICOMP is the registered trademark of the Group. © Premier Farnell plc 2007.

TOLERANCES:  
UNLESS OTHERWISE SPECIFIED, DIMENSIONS ARE FOR REFERENCE PURPOSES ONLY.

DRAWN BY:	DATE:
Kavitha	31/08/07
CHECKED BY:	DATE:
Suresh	31/08/07
APPROVED BY:	DATE:
G.Cook	17/09/07

DRAWING TITLE:			
13-04-19 TSS URM70			
SIZE	DWG NO.	ELECTRONIC FILE	REV
A	M10000450	1169575_DWG	A
SCALE: NTS	U.O.M.: mm (Inches)	SHEET: 1 OF 2	



PART NO.

13-04-19 TSS URM70

REVISIONS

ECN #	REV	DESCRIPTION	DRAWN	DATE	CHECKD	DATE	APPRVD	DATE
-	A	RELEASED	Kavitha	31/8/07	Suresh	31/8/07	G. C	17/9/07

Specification Table

Number	Description	Material	Finish	Part Number
1	Shell	Brass	Silver 70µ" Minimum	13-04-19 TSS URM70
2	Body			
3	Insulation	Teflon	None	
4	Gasket	Silicone	Red	
5	Washer	Brass	Nickel 100µ" Minimum	
6	Spring Washer	SK-5	Silver 70µ" Minimum	
7	Washer	Brass	Nickel 100µ" Minimum	
8	Braid Clamp		Silver 70µ" Minimum	
9	Gasket	Silicone	Red	
10	Washer	Brass	Silver 70µ" Minimum	
11	Nut			
12	Centre Contact			

<http://www.farnell.com>

<http://www.newark.com>

<http://www.cpc.co.uk>

This data sheet and its contents (the "Information") belong to the Premier Farnell Group (the "Group") or are licensed to it. No licence is granted for the use of it other than for information purposes in connection with the products to which it relates. No licence of any intellectual property rights is granted. The Information is subject to change without notice and replaces all data sheets previously supplied. The Information supplied is believed to be accurate but the Group assumes no responsibility for its accuracy or completeness, any error in or omission from it or for any use made of it. Users of this data sheet should check for themselves the Information and the suitability of the products for their purpose and not make any assumptions based on information included or omitted. Liability for loss or damage resulting from any reliance on the Information or use of it (including liability resulting from negligence or where the Group was aware of the possibility of such loss or damage arising) is excluded. This will not operate to limit or restrict the Group's liability for death or personal injury resulting from its negligence. SPC MULTICOMP is the registered trademark of the Group. © Premier Farnell plc 2007.

TOLERANCES:

UNLESS OTHERWISE SPECIFIED, DIMENSIONS ARE FOR REFERENCE PURPOSES ONLY.

DRAWN BY:	DATE:
Kavitha	31/08/07
CHECKED BY:	DATE:
Suresh	31/08/07
APPROVED BY:	DATE:
G.Cook	17/09/07

DRAWING TITLE:

13-04-19 TSS URM70

SIZE A	DWG NO. M10000450	ELECTRONIC FILE 1169575_DWG	REV A
SCALE: NTS		U.O.M.: mm (Inches)	SHEET: 2 OF 2